

**SCHEME OF STUDIES**  
**DIPLOMA IN MECHANICAL ENGINEERING**  
**(C-20)**

# **V SEMESTER**

**CURRICULUM STRUCTURE**

**V Semester Scheme of Studies - Diploma in Mechanical Engineering [C-20]**

Pathway	Course Category / Teaching Department	Course Code	Pathway Title	Hours per Semester			Total contact hrs /Semester	Credits	CIE Marks		SEE-1 Marks (Theory)		SEE-2 Mark (Practical)		Total Marks	Min Marks for Passing (including CIE marks)	Assigned Grade	Grade Point	SGPA and CGPA
				L	T	P			Max	Min	Max	Min	Max	Min					
<b>Programme Specialization Pathway</b>																			
1	ES/ME Specialization pathways in emerging areas Student may select any one of the specializations	20ME51I	Automation and Robotics	104	52	312	468	24	240	96	60	24	100	40	400	160			
		20ME52I	Heating, Ventilation and Air Conditioning (HVAC)	104	52	312	468	24	240	96	60	24	100	40	400	160			
		20ME53I	Advanced Manufacturing Technologies	104	52	312	468	24	240	96	60	24	100	40	400	160			
		20ME54I	- E-Mobility	104	52	312	468	24	240	96	60	24	100	40	400	160			
<b>Science and Research Pathway</b>				L	T	P	Total	Credit	CIE Marks		SEE Marks								
									Max	Min	Max	Min							
2	BS/SC/ME Specialization pathway in Science and Research (Student need to take all four papers in this pathway)	20SC51T	Paper 1-Applied Mathematics	52	26	0	78	6	50	20	50	20	100	40					
		20SC52T	Paper 2 - Applied Science	52	0	52	104	6	50	20	50	20	100	40					
		20RM53T	Paper 3 - Research Methodology	52	0	52	104	6	50	20	50	20	100	40					
		20TW54P	Paper 4 - Technical Writing	39	13	52	104	6	60	24	40	16	100	40					
			Total	195	39	156	390	24	210	84	190	76	400	160					
<b>Entrepreneurship Pathway</b>																			
3	ES/ME	20ET51I	Entrepreneurship and start up	104	52	312	468	24	240	96	160	64	400	160					

L: - Lecture T: - Tutorial P: - Practical BS- Basic Science: ES-Engineering Science: SC: Science

**Note: In 5th Semester student need to select any one of the pathways consisting of 24 credits  
Students can continue their higher education irrespective of the Pathway selected**

**CURRICULUM STRUCTURE**

**VI Semester Scheme of Studies - Diploma in Mechanical Engineering [C-20]**

Pathway	Course Category / Teaching Department	Course Code	Pathway	Course		Total contact	Credits	CIE Marks		SEE Marks		Total Marks	Min Marks for Passing	Assigned Grade	Grade	SGPA and CGPA
								Max	Min	Max	Min					
Internship	ES/ME	20ME61S	Specialisa tion pathway	Internship/ project	40 Hours / week Total 16 Weeks	640	16	240	96	160	64	400	160			
		20ME61R	Science and Research Pathway	Research project	40 Hours / week Total 16 Weeks	640	16	240	96	160	64	400	160			
		20ME61E	Entreprene urship and start up	Minimum Viable Product -MVP/ Incubation/ Startup proposal	40 Hours / week Total 16 Weeks	640	16	240	96	160	64	400	160			

**Note: Student shall undergo Internship/Project/research project/MVP/Incubation/Startup proposal in the same area as opted in 5<sup>th</sup> semester pathway.**





**Government of Karnataka**  
**DEPARTMENT OF COLLEGIATE and TECHNICAL EDUCATION**

<b>Program</b>	<b>Mechanical Engineering</b>	<b>Semester</b>	<b>5</b>
<b>Course Code</b>	<b>20ME51I</b>	<b>Type of Course</b>	<b>L:T:P (104: 52: 312)</b>
<b>Specialization</b>	<b>Automation and Robotics</b>	<b>Credits</b>	<b>24</b>
<b>CIE Marks</b>	<b>240</b>	<b>SEE Marks</b>	<b>160</b>

### Introduction:

Welcome to the curriculum for the Specialisation Pathway – **Automation and Robotics**. This specialisation course is taught in Bootcamp mode. Bootcamps are 12 weeks, intense learning sessions designed to prepare you for the practical world – ready for either industry or becoming an entrepreneur.

Automation is the process of use of automatic devices and controls in mechanized production line. It is applied to variety of systems in which there is a significant substitution of mechanical, electrical, or computerized action for human effort and intelligence. Automation technology has matured to a point where a number of other technologies have developed from it and have achieved a recognition and status of their own. Robotics is one of these technologies. Robots can work in hazardous conditions, such as poor lighting, toxic chemicals, or tight spaces. They are capable of lifting heavy loads without injury or tiring. Robots increase worker safety by preventing accidents. In addition to these, automated robotics makes production efficient, responsive, flexible and innovative which are key elements of staying competitive. Henceforth, is the Specialization pathway - **Automation and Robotics**

You will be assisted through the course, with development-based assessments to enable progressive learning. In this course, you'll learn how to Automate different activities in various applications and also incorporate Robots for required activities in an automation system.

Leading to the successful completion of this bootcamp, you shall be equipped to either do an **Internship** in an organisation working on **Automation and Robotics** or take up a **Project** in the related field. After the completion of your Diploma, you shall be ready to take up roles like Automation Engineer, Floor shop Manager, Production In-charge and also can become Entrepreneur in the related field and more.

This course will teach you about Designing an Automation system with or without Robots, Selection of the equipment's for an Automation and Robotics System, integrate SCADA and IoT in Automation system and more. Details of the curriculum is presented in the sections below

### Pre-requisite

Before the start of this specialisation course, you will have prerequisite knowledge gained in the first two years on the following subjects:

1st year -Engineering Mathematics, Communication Skills, Computer Aided Engineering Graphics, Statistics & Analysis, Basic IT Skills, Fundamentals of Electrical and Electronics Engineering, Project Management skills Engineering Materials and Mechanical Workshop

2nd year-Mechanics of Materials, Machine Tool Technology, Manufacturing Process, Fluid Power Engineering, Product Design and Development, Operations Management, CNC Machines and Elements of Industrial Automation. In this year of study, you shall be applying your previous years learning along with specialised field of study into projects and real-world applications.

### **Course Cohort Owner**

A Course Cohort Owner is a faculty from the core discipline, who is fully responsible for one specialised field of study and the cohort of students who have chosen to study that specialised field of study.

### **Guidelines for Cohort Owner**

1. Each Specialized field of study is restricted to a Cohort of 20 students which could include students from other relevant programs.
2. One faculty from the Core Discipline shall be the Cohort Owner, who for teaching and learning in allied disciplines can work with faculty from other disciplines or industry experts.
3. The course shall be delivered in boot camp mode spanning over 12 weeks of study, weekly developmental assessments and culminating in a mini capstone.
4. The industry session shall be addressed by industry subject experts (in contact mode/online / recorded video mode) in the discipline only.
5. The cohort owner shall be responsible to identify experts from the relevant field and organize industry session as per schedule.
6. Cohort owner shall plan and accompany the cohort for any industrial visits.
7. Cohort owner shall maintain and document industrial assignments, weekly assessments, practices and mini project.
8. The cohort owner shall coordinate with faculties across programs needed for their course to ensure seamless delivery as per time table
9. The cohort owner along with classroom sessions can augment or use supplementally teaching and learning opportunities including good quality online courses available on platforms like Karnataka LMS, Infosys Springboard, NPTEL, Unacademy, SWAYAM, etc.

**Course Outcomes:** At the end of the Course, the student will be able to:

<b>CO-01</b>	Identify the possibilities of automation in a production system
<b>CO-02</b>	Select the Hardware components required for Automation and establish communication network by using industry standard protocol
<b>CO-03</b>	Develop, simulate, interface and Execute an Automation system for a given Application
<b>CO-04</b>	Develop, simulate, interface and Execute Robot Program for a specified process in an Automation system
<b>CO-05</b>	Integrate HMI, SCADA and IIOT in an automation system

## Detailed course plan

Week	C O	P O	Days	1 <sup>st</sup> session (9am to 1 pm)	L	T	P	2 <sup>ND</sup> session (1.30pm to 4.30pm)	L	T	P
1	1		1	Present an overview on Conventional Production process starting from procurement of raw materials to finished product and delivery to the customer			4	Virtual tour on modern industries such as automobile sector, aviation sector, Fast Moving Consumer Goods (FMCG) sector etc.  Discuss Hierarchy of Industrial Automation, Industrial Automation pyramid.  Present an Overview on the Levels of Automation- <ul style="list-style-type: none"> <li>• Device level</li> <li>• Machine Level</li> <li>• Cell Level</li> <li>• Plant Level</li> <li>• Enterprise Level</li> </ul>	1		2
	1		2	<ul style="list-style-type: none"> <li>• Understand Design Thinking as a problem-solving process.</li> <li>• Impact of design thinking on design, manufacturing and delivery</li> <li>• Describe the principles of Design Thinking</li> <li>• Discuss the feasibility of the operations that can be Automated in a Production system</li> <li>• Identify the operations that cannot be Automated in a Production system and requires human intervention</li> </ul>	2		2	Importance of Industrial automation in the Indian manufacturing industry  Challenges and Limitations of industrial automations  Present an Overview of Industry 4.0 and Challenges in implementation of Industry 4.0 in India	1		2

	1,2		3	Recap on Technologies adopted in Automation  Demonstrate- <ul style="list-style-type: none"> <li>• Sensors Technology</li> <li>• Drives and Actuators</li> <li>• Relays and Switches</li> <li>• PLC and Programming</li> <li>• Communication Protocols</li> </ul>	1	3	Modern tools used for Industrial Automation- PAC, SCADA, HMI, DCS, AI, IIOT, etc  Importance of IEC, ISO, NEMA, JIC and other standards used in automation.	2	1
	1,3		4	Programmable Automation Controllers (PACs)-Role of PACs in modern industries.  Discuss Proportional Integral Derivative (PID)-Proportional Response, Integral Response, Derivative Response,  Demonstrate Applications of PAC and PID	2	2	Programming with IEC 61131-3 Languages <ul style="list-style-type: none"> <li>• Ladder Diagrams</li> <li>• Structural Text language</li> <li>• Sequential function Chart</li> <li>• Functional Block diagram</li> <li>• Instruction List</li> </ul>	1	2
			5	<b>Developmental Weekly Assessment</b>			<b>Assessment Review and corrective action</b>		3
			6	<b>Industry Class on Sensors and Actuators + Industry Assignment</b>		5			
2	3		1	<b>PEER Discussion on Industry Assignment</b>		4	Recap and Practice PLC Ladder Diagram for Logic Gates, Timers, Counters	1	2
	3		2	Explain and Practice PLC Ladder Diagram for Compare, Jump and Subroutines	1	3	Explain and Practice PLC Ladder Diagram for Math Instructions and Shift Registers	1	2
	3		3	Explain and Practice PLC Program using Functional Block Diagram	1	3	Explain and Practice PLC Program using Functional Block Diagram	1	2
	3		4	Explain and Practice PLC Program using Structural Text language	1	3	Explain and Practice PLC Program using Structural Text language	1	2
			5	<b>Developmental Weekly Assessment</b>			<b>Assessment Review and corrective action</b>		3

			6	<b>Industry Class on PLC Programs practiced in Industry + Industry Assignment</b>			5			
3	2		1	<b>PEER Discussion on Industry Assignment</b>		4		Explain and demonstrate how to establish communication network with PLC systems using industry standard communication protocols for data transfer <ul style="list-style-type: none"> <li>Serial Communications</li> <li>ASCII Functions</li> <li>Parallel Communications</li> </ul>	1	2
	2		2	Explain and demonstrate different types of networking architecture Explain OSI model of networking Networking hardware	2		2	Demonstrate TCP/IP Protocol Introduction to IP Address, Subnet Mask, Networking Devices, Network topology	2	2
	2		3	Demonstrate Industrial Automation Communication Protocols - RS232-422-485 standards	2		2	Demonstrate the Network standards, Modbus, CAN bus, ControlNet, Ethernet, Profibus, FIP I/O, Static and Dynamic Routing principle	2	2
	2		4	Demonstrate HART, DH-485 and Foundation fieldbus etc.  Concepts of Wireless Networking	2		2	Latest trends in PLC communication protocols. Fundamental Parts and Characteristics of PLC communication Protocol Demonstrate Peer to Peer (PLC to PLC) & PLC to PC Communication protocols	1	2
			5	<b>CIE 1- Written and practice test</b>				<b>Assessment Review and corrective action</b>		3
			6	<b>Industry Class on Communication Protocol practiced in industry + Industry Assignment</b>			5			
4	5		1	<b>PEER Discussion on Industry Assignment</b>		4		<ul style="list-style-type: none"> <li>HMI (Human Machine Interface) - Types- Selection- Specifications</li> </ul> PLC with colour Touch screen Human Machine Interface (HMI): <ul style="list-style-type: none"> <li>Colour Touch Screen HMI panels and specifications, various industry interfaces on HMI panels, features of HMI panels</li> </ul>	1	2

	5	2	Working with HMI software Tool <ul style="list-style-type: none"> <li>• Configure PLC with HMI</li> <li>• Animation with graphical objects</li> <li>• Animate objects on an HMI screen to monitor motor status</li> <li>• Trend the data of a process parameter using a trend tool.</li> <li>• Create user groups and monitor screens with proper authentication.</li> <li>• Use security features to do tag logging and command execution</li> </ul>	2	2	<ul style="list-style-type: none"> <li>• Practice HMI programming involving alarms, trends and bar graphs</li> </ul>	1	2
	5	3	<ul style="list-style-type: none"> <li>• Practice control of a Motor through HMI</li> </ul>				2	5
	5	4	Supervisory data control and acquisition system (SCADA) <ul style="list-style-type: none"> <li>• Concepts of SCADA systems</li> <li>• SCADA hardware               <ol style="list-style-type: none"> <li>Field level instrumentation and control devices</li> <li>RTU- Remote terminal unit</li> <li>Communication systems</li> <li>Master control station</li> <li>Data processing computer systems</li> <li>Creating and Editing tax</li> <li>Creating Graphs and bar charts, Alarm configuration, Trends (Real time and Historical), Report generation</li> </ol> </li> <li>• SCADA Protocols</li> <li>• Application of SCADA</li> </ul>	4		Practice control of a Motor through SCADA software	1	2
		5	<b>Developmental Weekly Assessment</b>			<b>Assessment Review and corrective action</b>		3
		6	<b>Industry Class on HMI and SCADA + Industry Assignment</b>		5			
5	3	1	<b>PEER Discussion on Industry Assignment</b>		4	<b>Problem Statement:</b> Bottle filling has a constant speed of filling 20 bottles per minute. This speed	1	2

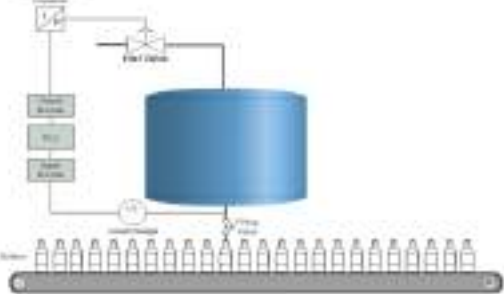
						<p>depends on level of the tank due to its head pressure. To maintain this speed, pressure head of the filling tank has to be maintained at a particular level. Implement this automation in PLC using Ladder Diagram programming language</p> <p><b>Diagram:</b></p>  <p><b>Condition:</b> To continuously maintain constant Pressure in the tank</p> <ol style="list-style-type: none"> <li>For the above case, Discuss the suitable sensor technology, PLC, Drives, Communication Protocol and Related Hardware components</li> <li>Select Hardware components from the Company catalogue and record their specifications in a DATA Sheet</li> <li>Develop a PLC Ladder Program for the above case, simulate, interface with PLC and execute</li> <li>Discuss the Applications of the above Case</li> </ol>		
--	--	--	--	--	--	---	--	--

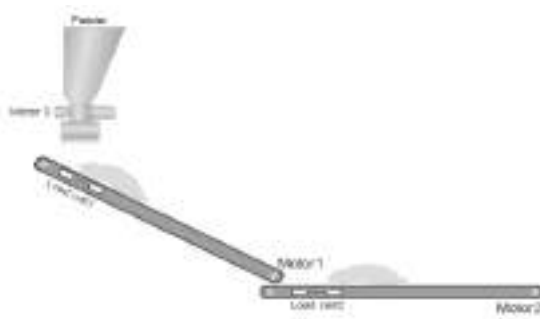

3	2	<p><b>Problem Statement:</b> A feeder drops material on the conveyor which sends material for further process through one more conveyor. Conveyor must start automatically when material is dropped on it. Implement automation of this in PLC using Ladder Diagram programming language.</p> <p><b>Diagram:</b></p>  <p><b>Condition:</b></p> <ul style="list-style-type: none"> <li>• Feeder has a motor mounted to feed material on conveyor belts.</li> <li>• Load cells are installed at the bottom of conveyor belts to detect if material is present on the conveyor belt.</li> <li>• When material falls on conveyor belt 1, motor 1 should start, and when material is present on conveyor belt 2, motor 2 remain On.</li> <li>• Switches can also be used sometimes to detect material's presence. But for more reliable operation, Load cells can be used as shown in the diagram above</li> </ul> <p>a) For the above case, Discuss the suitable sensor technology, PLC, Drives, Communication Protocol and Related Hardware components</p> <p>b) Select Hardware components from the Company catalogue and record their specifications in a DATA Sheet</p>	2	5
---	---	---	---	---

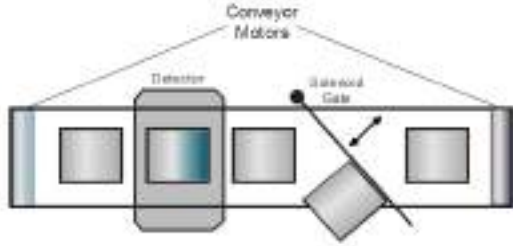
			<p>c) Develop a PLC Ladder Program for the above case, simulate, interface with PLC and execute</p> <p>d) Discuss the Applications of the above Case</p>		
3		3	<p><b>Problem Statement:</b> Parts are moving on the conveyor from one process line to other with a constant speed. Out of 1000-part, one part is taken out for quality check. Implement automation of this in PLC using Ladder Diagram programming language.</p> <p><b>Diagram:</b></p>  <p>The diagram shows a horizontal conveyor belt. On the left, there is a 'Detector' unit. Above the conveyor, there are 'Conveyor Motors'. On the right side of the conveyor, there is a 'Solenoid Gate' mechanism that can divert a part from the main conveyor line.</p> <p><b>Condition:</b></p> <ul style="list-style-type: none"> <li>To detect the parts, detector such as proximity switch, optical sensors or any other sensor is used.</li> <li>Connect output of this detector to Input Module of PLC which sets and resets image memory according to parts' detection.</li> <li>Give this detection, as an input to Up Counter which is incremented with each part's detection.</li> <li>Set counter preset value to 1000.</li> <li>Operate Solenoid for a few seconds until the part is diverted for quality check.</li> </ul> <p>a) For the above case, Discuss the suitable sensor technology, PLC, Drives, Communication Protocol and Related Hardware components</p> <p>b) Select Hardware components from the Company catalogue and record their specifications in a DATA Sheet</p> <p>c) Develop a PLC Ladder Program for the above case, simulate, interface with PLC and execute</p> <p>d) Discuss the Applications of the above Case</p>	2	5

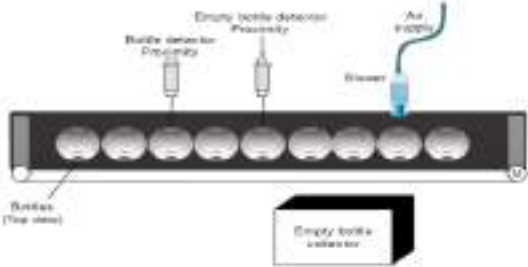
3		4	<p><b>Problem Statement:</b> After filling process, bottles are moved on the conveyor belt for packing process. Detect if any empty bottle is left on the conveyor and remove it from the conveyor. Implement automation of this in PLC using Ladder Diagram programming language.</p> <p><b>Diagram:</b></p>  <p><b>Condition:</b></p> <ul style="list-style-type: none"> <li>• Proximity sensors are used to detect bottles.</li> <li>• One proximity is calibrated such that it detects all the bottles passing on the conveyor. And other proximity is used such that it detects only empty bottle.</li> <li>• Use Bit Shift Register to shift a bit which is set when an empty bottle is detected.</li> <li>• Use a Pneumatic Cylinder or blower to throw an empty bottle out of the conveyor</li> </ul> <p>a) For the above case, Discuss the suitable sensor technology, PLC, Drives, Communication Protocol and Related Hardware components</p> <p>b) Select Hardware components from the Company catalogue and record their specifications in a DATA Sheet</p> <p>c) Develop a PLC Ladder Program for the above case, simulate, interface with PLC and execute</p> <p>d) Discuss the Applications of the above Case</p>	2	5
		5	CIE 2- Written and practice test	Assessment Review and corrective action	3

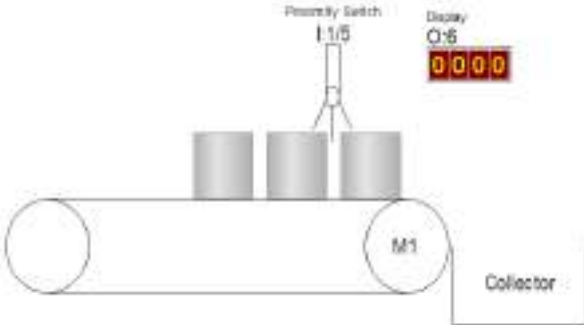
			6	<b>Industry Class on Automation in Industry + Industry Assignment</b>		5			
6	3		1	<b>PEER Discussion on Industry Assignment</b>		4	<p><b>Problem Statement:</b> Parts are moved on the conveyor. Count the number of parts collected at the end of the conveyor and display it on the display in PLC using Ladder Diagram programming language.</p> <p><b>Diagram:</b></p>  <p>The diagram shows a horizontal conveyor belt. On the left, a motor labeled 'M1' is connected to the belt. Three cylindrical parts are shown on the belt. Above the belt, a 'Proximity Switch I:1/5' is positioned to detect the parts. To the right of the switch is a 'Display O:6' showing the number '0000'. Below the belt, a 'Collector' is indicated.</p> <p><b>Condition:</b></p> <ul style="list-style-type: none"> <li>• Mount Proximity Switch to detect the parts.</li> <li>• Use output of proximity to counter as an input to increment data.</li> <li>• Convert this number into appropriate numerical and show number of parts collected.</li> <li>• Use Inductive or Capacitive Proximity switches are Depending on Metal or Non-Metal</li> <li>• Mount this sensor according to the size of parts present on the conveyor and width of conveyor so that this sensor can detect parts easily.</li> <li>• CUP is used to increment the number of parts collected.</li> </ul>	1	2

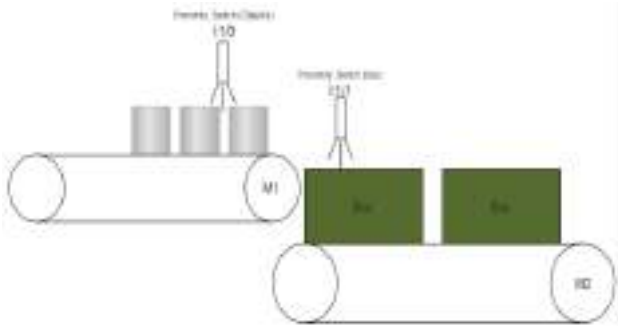

			<ul style="list-style-type: none"> <li>• Mount these switches such that switches detect assigned object only. For example, mount Square detector proximity such that it neither detects Rectangular blocks nor Balls.</li> <li>• Load counter values in registers for different objects. And load this value as soon as a particular type of object is detected.</li> </ul> <p>a) For the above case, Discuss the suitable sensor technology, PLC, Drives, Communication Protocol and Related Hardware components</p> <p>b) Select Hardware components from the Company catalogue and record their specifications in a DATA Sheet</p> <p>c) Develop a PLC Ladder Program for the above case, simulate, interface with PLC and execute</p> <p>d) Discuss the Applications of the above Case</p>		
3		3	<p><b>Problem Statement:</b> Objects are moving on a conveyor belt 1. When an empty box is detected, conveyor belt starts and 5pcs are packed in a box. When box is filled, it is carried to the storage area via conveyor belt 2. Implement automation of this process in PLC using Ladder Diagram programming language.</p> <p><b>Diagram:</b></p>  <p><b>Condition:</b></p>	2	5

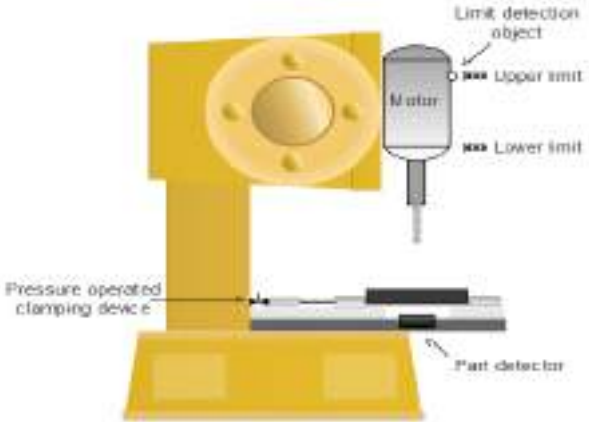
			<ul style="list-style-type: none"> <li>• Use proximity switches to detect moving objects on the conveyor belt 1 and to detect an empty box on conveyor belt 2.</li> <li>• Use counter to count number of objects to be packed.</li> <li>• Use timer such that when 5pcs are detected, conveyor runs for a while and stops when 5th object is finally collected in the box. Assume time by calculating conveyor belt speed.</li> <li>• When number of parts to be packed are detected timer is activated. When timer is over, it stops the conveyor until next empty box is detected.</li> <li>• Assuming time taken by the last 5th object is 2secs to be collected.</li> </ul> <p>a) For the above case, Discuss the suitable sensor technology, PLC, Drives, Communication Protocol and Related Hardware components</p> <p>b) Select Hardware components from the Company catalogue and record their specifications in a DATA Sheet</p> <p>c) Develop a PLC Ladder Program for the above case, simulate, interface with PLC and execute</p> <p>d) Discuss the Applications of the above Case</p>		
3		4	<p><b>Problem Statement:</b> Whenever a part is placed on the drilling table, pneumatic clamber clamps the part and drilling process is done. On completing the drilling process, the clamber releases the part by releasing pressure. When another part is detected, the process is repeated. Implement this in PLC using Ladder Diagram programming language</p> <p><b>Diagram:</b></p>  <p><b>Condition:</b></p>	2	5

				<ul style="list-style-type: none"> <li>• Set lower and upper limit of a motor to stop and start the drilling process. This is done for precise drilling and to obtain uniformity.</li> <li>• Pressure operated clamping device is used to hold the objects firmly. This is operated by air supply which is provided when an object is detected.</li> <li>• Limit detection object is placed on the motor to detect upper and lower limit by the switches.</li> </ul> <p>a) For the above case, Discuss the suitable sensor technology, PLC, Drives, Communication Protocol and Related Hardware components</p> <p>b) Select Hardware components from the Company catalogue and record their specifications in a DATA Sheet</p> <p>c) Develop a PLC Ladder Program for the above case, simulate, interface with PLC and execute</p> <p>d) Discuss the Applications of the above Case in other machines</p>							
			5	<b>Developmental Weekly Assessment</b>				<b>Assessment Review and corrective action</b>			3
			6	<b>Industry Class on Trends in Automation + Industry Assignment</b>			5				
	3		1	<b>PEER Discussion on Industry Assignment</b>		4		<p><b>Problem Statement:</b> Implement automation to control Continuous Stirred Tank Reactor of a chemical plant in PLC using Ladder Diagram programming language</p> <p><b>Diagram:</b></p>	1		2

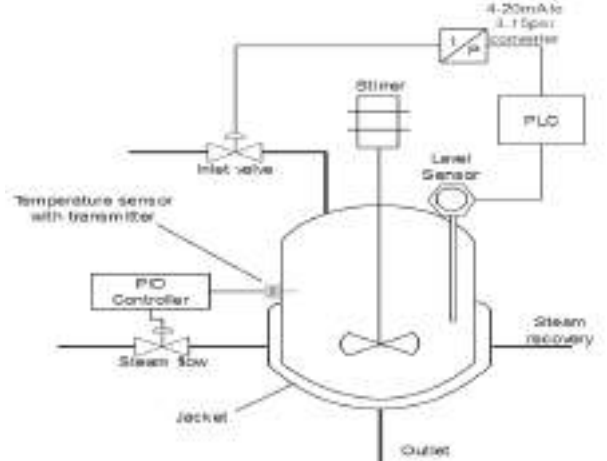

7							 <p><b>Condition:</b></p> <ul style="list-style-type: none"> <li>• Three parameters are controlled in this reactor. Temperature, Flow and Level of the tank</li> <li>• Use PID Controller</li> </ul> <p>For the Above case, Develop a PLC program</p>		
	3		2	<p><b>Problem Statement:</b> Water bottles are moved on a conveyor for capping. Screw caps are screwed to close the opening end of the bottle using rotating mechanism. Implement this in PLC using Ladder Diagram programming language</p> <p><b>Diagram:</b></p>		2	5		

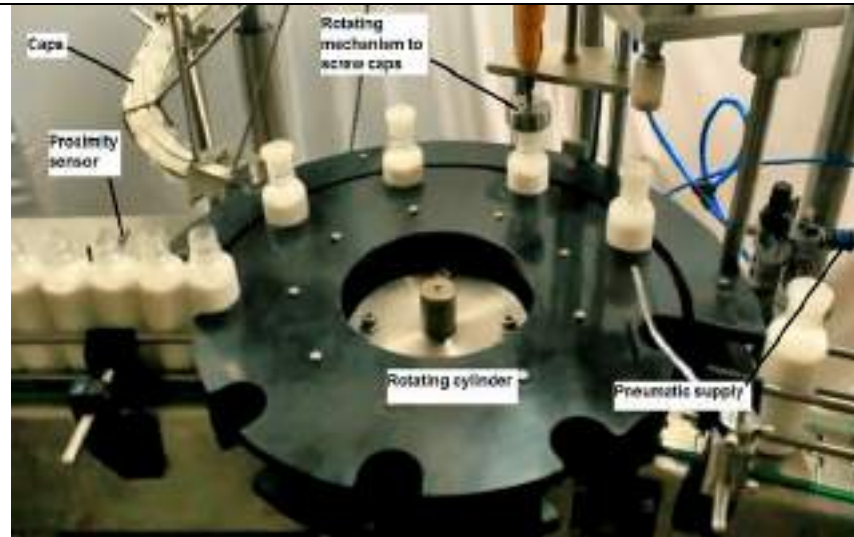

**Condition:**

- To sense the bottle, proximity sensor is used.
  - Used a timer to stop the cylinder motor for 2secs to screw caps.
  - Used one more timer to run the motor for 1sec to rotate the cylinder.
  - Bit Shift register is also used to perform this operation.
  - Count the number of steps capping machine is placed from the sensor and set bit position to operate capping machine accordingly.
  - In this example as you can see, bottle is 7 steps away from the proximity switch, so if Bit register B3:0 is used, then capping machine should be operated when B3:0/0 is shifted to B3:0/6.
  - Two inputs are given to this Capping machine, electric supply to run motor and pneumatic supply to push machine down cap ram.
- a) For the above case, Discuss the suitable sensor technology, PLC, Drives, Communication Protocol and Related Hardware components
  - b) Select Hardware components from the Company catalogue and record their specifications in a DATA Sheet
  - c) Develop a PLC Ladder Program for the above case, simulate, interface with PLC and execute
  - d) Discuss the Applications of the above case

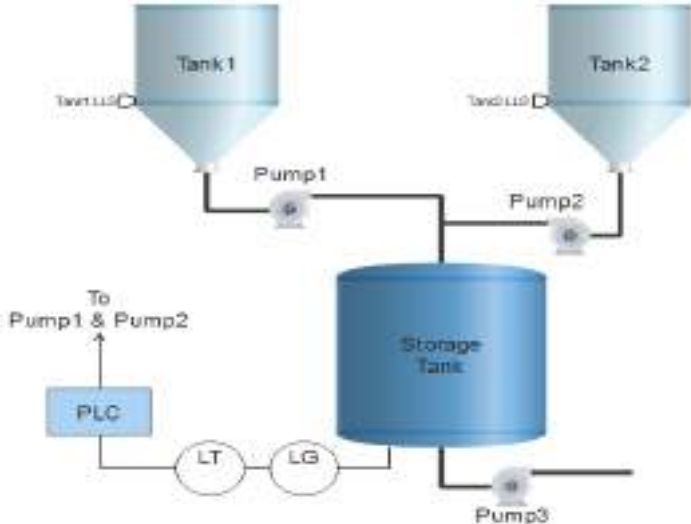
3	3	<p><b>Problem Statement:</b> Two tanks have same products filled. Draining from these depends on the requirement from the storage tank. Implement automation in this Drainage tank using with PLC using Ladder Diagram programming language</p> <p><b>Diagram:</b></p>  <p><b>Condition:</b></p> <ul style="list-style-type: none"> <li>• Level gauge is used to measure level of the storage tank continuously</li> <li>• Level gauge is connected with Level Transmitter which converts corresponding level output in 4-20mA equivalent.</li> <li>• Analog I/O Modules are chosen to deal with Analog signals.</li> <li>• Pumps are used to drain material from both the tanks at the same time.</li> <li>• Two low level switches are used to detect low level of tanks 1 and 2 which turns Pumps OFF when low level is reached.</li> <li>• Height of storage tank is 5meters that is 500cm and the level which is to be maintained is 470cm.</li> </ul> <p>a) For the above case, Discuss the suitable sensor technology, PLC, Drives, Communication Protocol and Related Hardware components</p> <p>b) Select Hardware components from the Company catalogue and record their specifications in a DATA Sheet</p> <p>c) Develop a PLC Ladder Program for the above case, simulate, interface with PLC and execute</p>	2	5
---	---	---	---	---

				d) Discuss the Applications of the above Case		
	3		4	<b>Problem Statement:</b> Potato chips are made and ready to be packed. But before that, it goes through a conveyor in which final quality check is done, burnt chips are detected and removed from the process line. Implement this in PLC using Ladder Diagram programming language	2	5

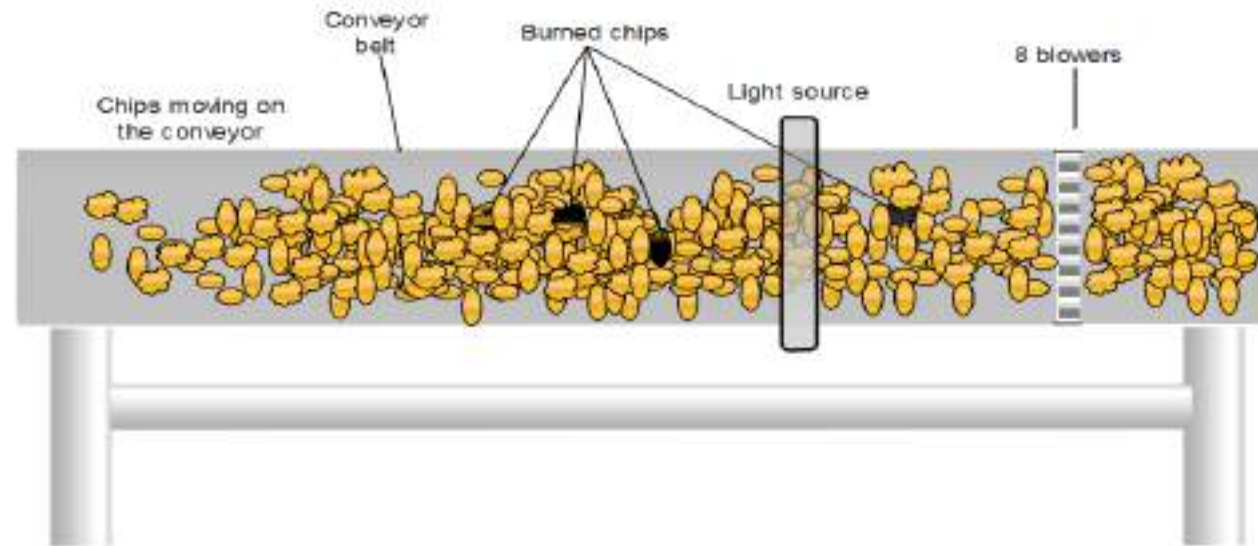
**Diagram:****Condition:**

- To detect burned chips, light source and sensors are used.
- Light source is used so light detectors such as Light Dependent Resistors are used to detect the burned chips.
- Blowers are used to throw burned chips away from the conveyor when detected.
- There are total number of 8 blowers. Number of blowers to be used depends on the width of a conveyor belt.
- Time measurement of an event to take place can be used here to measure what time burned chips take to reach from light source to blowers when detected.
- Set this time as pre-set of a timer to operate particular blower.
- There are 8 blowers, so 8 light detecting circuits must be used in order to operate all blowers.
- Let us assume we are using Light Dependent Resistor. To use this resistor, threshold has to be set that is darkest color to be passed as a good quality product. If chips are darker than the desired level, light source detects it and activates corresponding circuit.
- So, output of this circuit is normally high and to activate blower, normally low logic has to be set while programming or we can even invert output from LDR circuit.

				Develop a PLC Ladder Program for the above case						
		5	<b>CIE 3- Written and practice test</b>				<b>Assessment Review and corrective action</b>		<b>3</b>	
		6	<b>Industry Class on Automation in process industry + Industry Assignment</b>			5				
<b>8</b>	4		1	<b>PEER Discussion on Industry Assignment</b>		4	Concepts of Industrial Robots, Applications of Robotics, Types of robots, Configurations of robots – Articulated Robot, Polar configuration, SCARA, Cartesian Co-ordinate Robot, Delta Robot, Key Components of Robot.	3		
	4		2	Demonstrate Wrist configuration, Work Volume Degree of Freedom- Forward and Back, Up and Down, Left and Right, Pitch, Yaw, Roll,  Joint Notation & Type of joints in robot- Linear Joint (L Joint), Orthogonal Joint (O Joint), Rotational Joint (R Joint), Twisting Joint (T Joint), Revolving Joint (V Joint)	2	2	End Effectors- Grippers, Tools, Types of grippers,  Factors to be considered for Selecting a Gripper,  Robotic Drives- Electric Drive, Pneumatic Drive, Hydraulic Drive	3		
	4		3	Demonstrate Robot Control systems- • Point- to Point control Systems • Continuous Path Control • Intelligent control • Controller Components • System Control	1	3	Present a Robotic Coordinate system using a robot • Joint co-ordinate system • Rectangular co-ordinate system • User or object coordinate system • Tool coordinate system. Steps to define user co-ordinate system. • Defining X, Y, Z co-ordinate system • Verifying co-ordinate system by multiple motion movements.	1	<b>2</b>	
	4		4	Jogging Practice on robot with different coordinate systems				2	<b>5</b>	
			5	<b>Developmental Weekly Assessment</b>				<b>Assessment Review and corrective action</b>		<b>3</b>
			6	<b>Industry Class on interfacing of Robots with peripheral devices + Industry Assignment</b>			5			
<b>9</b>	4		1	<b>PEER Discussion on Industry Assignment</b>			Introduction about Simulation software. Creating new model in Simulation Software.	1	<b>2</b>	

						Importing different types of robots Identify the position variation in robots Perform Robot axis movements			
	4		2	Practice simple robot program using simulation software			2		5
	4		3	Practice simple robot program using simulation software			2		5
	4		4	Practice simple robot program using simulation software			2		5
			5	<b>CIE 4- Written and practice test</b>			<b>Assessment Review and corrective action</b>		3
			6	<b>Industry Class on Robot Programming + Industry Assignment</b>		5			
<b>10</b>	4		1	<b>PEER Discussion on Industry Assignment</b>		4	Develop a simple welding Robot program and simulate using suitable software.	1	2
	4		2	Develop a simple welding Robot program and simulate using suitable software			2		5
	4		3	Interface the above welding program with a Physical Robot Consider all required parameters and Tools and Execute the same. Perform Quality check			2		5
	4		4	Interface the above welding program with a Physical Robot Consider all required parameters and Tools and Execute the same.			2		5
			5	<b>Developmental Weekly Assessment</b>			<b>Assessment Review and corrective action</b>		3
			6	<b>Industry Class on Robots in Welding + Industry Assignment</b>		5			
<b>11</b>	4		1	<b>PEER Discussion on Industry Assignment</b>		4	<b>Problem Statement:</b> Objects are moving on a conveyor belt 1. When an empty box is detected, conveyor belt starts and 5pcs are packed in a box. When box is filled, it is carried to the storage area via conveyor belt 2. Integrate a robot with the system to pick the filled box from conveyor belt 2 and place it on a fork lift truck	1	2

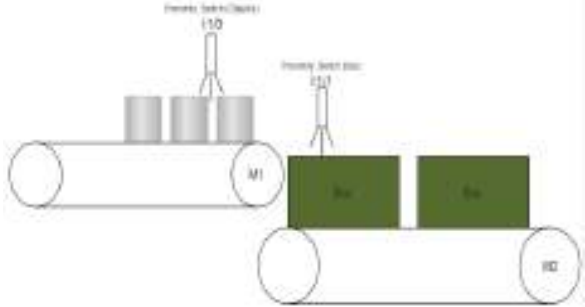
										
							<b>Develop and execute an Automated system for the above condition</b>			
	4		2	<b>Develop and execute the above Automated system</b>				2		5
	4		3	<b>Develop and execute the above Automated system</b>				2		5
			4	<b>Develop and execute the above Automated system</b>				2		5
			5	<b>CIE 5- Written and practice test</b>			<b>Assessment Review and corrective action</b>			3
			6	<b>Industry Class on Robot for PICK and PLACE + Industry Assignment</b>		5				
<b>12</b>	5		1	<b>PEER Discussion on Industry Assignment</b>		4	<ul style="list-style-type: none"> <li>• Concepts of IIOT- How it works</li> <li>• How IIoT is Improving Operational Effectiveness Transforming Legacy Systems, Greater Energy Efficiency, Data Analytics Get Smarter, Cobots Bring Connected Support to Human workers, Digital Twins are Gaining Traction Among Enterprises</li> </ul>	1		2
	5		2	<ul style="list-style-type: none"> <li>• Convergence of Operation Technology and Information Technology</li> <li>• Technologies which bring Convergence of OT and IT                             <ul style="list-style-type: none"> <li>➤ No code Application</li> <li>➤ Digital Twins</li> <li>➤ Augmented Reality</li> <li>➤ Edge computing</li> </ul> </li> </ul>		4	<b>BENEFITS OF IIOT</b> <ul style="list-style-type: none"> <li>• Improving Inventory Management</li> <li>• Simplified process control</li> <li>• Cloud-Based Inventory Systems</li> <li>• Gain Supply Chain Visibility</li> <li>• Improves Product Design &amp; Quality Controls</li> </ul>			3



							<ul style="list-style-type: none"> <li>• Real-Time Insights Provide Greater Business Agility</li> <li>• Location Tracking Offers Surprising Cost Savings</li> <li>• Reduced Downtime and Repair Costs via Predictive Maintenance, Safety and Compliance</li> </ul>			
	5		3	<ul style="list-style-type: none"> <li>• Risks and Challenges Associated with IIOT</li> <li>• Security considerations for IIOT                             <ul style="list-style-type: none"> <li>➤ Cybersecurity challenge</li> <li>➤ Potential Human Impact</li> <li>➤ Murky Regulatory Guidance</li> <li>➤ Data Management</li> <li>➤ Interoperability challenges</li> <li>➤ Cyber hacking</li> <li>➤ IP Leakage</li> <li>➤ Production Sabotage</li> </ul> </li> </ul>	4		<ul style="list-style-type: none"> <li>• Concept of Artificial Intelligence (AI)</li> <li>• Bringing the power of AI to the IOT                             <ul style="list-style-type: none"> <li>➤ Edge computing</li> <li>➤ Collaborative robots (COBOTS)</li> <li>➤ Digital twins</li> <li>➤ Autonomous Delivery robots</li> </ul> </li> <li>• Selecting right IIOT platform and Partner</li> </ul>	3		
	5		4	<ul style="list-style-type: none"> <li>• <b>Case study</b> - IIoT with other emerging technologies</li> </ul>		4	<ul style="list-style-type: none"> <li>• <b>Case study</b> - IIoT with other emerging technologies</li> </ul>			3
	5		5	<b>Developmental Weekly Assessment</b>			<b>Assessment Review and corrective action</b>			3
	5		6	<b>Industry Class on SCADA and IIOT in Automation + Industry Assignment</b>		5				
<b>13</b>			1	<p style="text-align: center;"><b>Internship</b></p> <p>a) Secondary research on various industries and their operations to identify at least 3 companies along with the areas of work interest and develop an internship plan that clearly highlights expectations from the industry during the internship.</p> <p>b) Design and develop a cover letter for an internship request to all 3 identified companies and the resume to be submitted to potential companies.</p> <p>c) Prepare for an internship interview to highlight your interests, areas of study, career aspirations and</p>			<p style="text-align: center;"><b>Project</b></p> <p>a) Identification of the problem statement (from at least 3 known problems) the students would like to work as part of the project – either as provided by faculty or as identified by the student. Document the impact the project will have from a technical, social and business perspective.</p> <p>b) Design and develop the project solution or methodology to be used to solve at least one of the problems identified.</p>			<b>40 HRS</b>

				<p><b>personnel competence - including the areas of learning you expect to learn during internship</b></p>	<p><b>c) Prepare a project plan that will include a schedule, WBS, Budget and known risks along with strategies to mitigate them to ensure the project achieves the desired outcome.</b></p>	
--	--	--	--	--	--	--

### References:

- 1 Programmable logic Controllers by W. BOLTON
- 2 Digital electronics By FLYOD
- 3 Exploring PLC with applications By PRADEEP KUMAR SRIVATSAVA
- 4 Automation, Production systems and Computer integrated Manufacturing By MIKELL GROOVER
- 5 Sensors Hand book-SABRIE SOLOMAN-MC-GRAW HILL publications
- 6 Hand book of Modern Sensors, Physics, Designs and Applications- JACOB FRADEN-Springer Publications
- 7 Electric Motors and Drives BY AUSTIN HUGHES and BILL DRURY
- 8 Automating Manufacturing Systems with PLC by Hugh Jack
- 9 Thomas Braunl, Embedded Robotics: Mobile Robot Design and Application with Embedded Systems, 2nd ed., Springer, 2006.
- 10 John M. Holland, Designing Autonomous Mobil Robots: Inside the Mind of an Intelligent Machine, Newnes, 2003.
- 11 Springer Handbook of Automation by Shimon Y. N
- 12 Industrial Robotics technology, programming and Application by Mikelle P Groover
- 13 SCADA: Supervisory Control and Data Acquisition, Fourth Edition by A\_Boyer
- 14 PLCs & SCADA - Theory and Practice First Edition, Kindle Edition by Rajesh Mehra and Vikrant Vij
- 15 The Internet of things by Samuel Greengard

16 Getting Started with Internet of Things by Cuno Pfister

### CIE and SEE Assessment Methodologies

CIE Assessment	Assessment Mode	Duration In hours	Max Marks
Week 3	CIE 1- Written and practice test	4	30
Week 5	CIE 2- Written and practice test	4	30
Week 7	CIE 3- Written and practice test	4	30
Week 9	CIE 4- Written and practice test	4	30
Week 11	CIE 5- Written and practice test	4	30
	On line Course work (Minimum 10 hours online course with certification from (SWAYAM/NPTEL/Infosys Springboard)		40
	Profile building for Internship / Submission of Synopsys for project work		20
Portfolio evaluation (Based on industrial assignments and weekly developmental assessment) *			30
<b>TOTAL CIE MARKS (A)</b>			<b>240</b>
<b>SEE 1 - Theory exam (QP from BTE) Conducted for 100 marks 3 hrs duration reduced to 60 marks</b>		<b>3</b>	<b>60</b>
<b>SEE 2 - Practical</b>		<b>3</b>	<b>100</b>
<b>TOTAL SEE MARKS (B)</b>			<b>160</b>
<b>TOTAL MARKS (A+B)</b>			<b>400</b>

\* The industrial assignment shall be based on peer-to-peer assessment for a total of 10 marks (on a scale of 1 to 10) and in the event of a group assignment the marks awarded will be the same for the entire group, the developmental assessment will be for a total of 20 marks and based on MCQ/case study/demonstration and such other assignment methods

### Assessment framework for CIE (1 to 5)

**Note: Theory to be conducted for 1 hour and practice for 3 hours, total duration of exam – 4 hours**

### CIE 2- Model Question Paper

<b>Programme</b>	<b>Mechanical Engineering</b>	<b>Semester</b>	<b>V</b>		
<b>Course</b>	<b>Automation and Robotics</b>	<b>Max Marks</b>	<b>30</b>		
<b>Course Code</b>	<b>20ME51I</b>	<b>Duration</b>	<b>4 hours</b>		
<b>Name of the course coordinator</b>					
Note: Answer one full question from each section.					
<b>Qn.No</b>	<b>Question</b>	<b>CL L3/L4</b>	<b>CO</b>	<b>PO</b>	<b>Marks</b>
<b>Section-1 (Theory) – 10 marks</b>					
1.a)	The cutting area is an important section in the float glass production line, which includes many productions control equipment, such as longitudinal cutting, transverse cutting, conveying roller table, etc. The main control part of the whole system is PLC, and the monitoring will be undertaken by HMI. Is it required to use both HMI and PLC, As opposed to just a PLC in this Production line? Justify your statement.	L4	5		03
b)	In any manufacturing plant, motor plays a vital role. Controlling the speed of the motor according to the prerequisite is a requirement in any plant. If any problem occurs in a process which cannot be tackled by the operator, then error should be checked by the programmer. It is not compulsory that programmers should be present at the place to solve the issue. Henceforth, how do you Remotely control the speed of the Motor using HMI.	L3	5		07
2.a)	In a manufacturing plant, 3 different machines are to be controlled from a single location with real time information. Specific production data are to be gathered from ERP system. Similarly, equipment data and sensor information are also required for cloud-based analytics resulting in predictive maintenance. Discuss the hardware and Protocols of SCADA and suggest suitable solution to the case with justification	L4	5		04

b)	An oil industry is constantly having issues on Oil leakage. Constant monitoring was required to detect this issue and resolve to prevent accidents. Henceforth, the company decided to introduce Alarms. Device a method to detect Gas Leakage and to strike an Alarm on detection using HMI alarm.	L3	5		06
<b>Section-2 (Practical) - 20 marks</b>					
3)	One open tank is installed in the water plant in which liquid level is to be controlled. Develop a PLC Ladder Program for the following condition: a) When Level High is detected, outlet flow is allowed and inlet flow is blocked b) When Level Low is detected, Outlet flow is blocked and inlet flow is allowed until high level is achieved Also, Simulate the above case. Suggest PLC and protocols for the above case	L4	3		20
4)	In a Process industry, filled bottles are moved on the conveyor belt for packaging process. Device a PLC Ladder Diagram program to a) Pick one bottle after every 500 bottles for inspection. Simulate, interface with PLC and execute the above case.	L4	3		20

**Note : Theory questions shall be aligned to practical questions**

#### Scheme of Evaluation for Practical question- Section 2

Sl. No	Description	Marks: 20
1	Analyze the given Problem Statement	02
2	Selecting suitable sensor technology, PLC, Drives for the above case,	05
3	Develop and simulate PLC Ladder Program for the above case	05
4	Suggest/Interface with PLC and execute using suitable communication protocols	05
5	Execution of the same program for different boundary conditions	03
	<b>Total</b>	<b>20</b>

**Assessment framework for SEE 1 (Theory)**

<b>Programme : Mechanical Engineering</b>		<b>Semester: V</b>		
<b>Course : Automation and Robotics</b>		<b>Max Marks: 100 Marks</b>		
<b>Course Code : 20ME51I</b>		<b>Duration: 3 Hrs</b>		
<b>Instruction to the Candidate:</b> Answer one full question from each section.				
<b>Q.No</b>	<b>Question</b>	<b>CL (L3/L4)</b>	<b>CO</b>	<b>Marks</b>
<b>Section-1</b>				
1.a)	When a product is manufactured, there is always a start line and a finish line. The start line is where the raw materials enter the factory, and the finish line is where the final product is complete and ready to be shipped. A process turns the raw materials into the final finished product between the start and finish lines. This process can happen either manually or automatically. How does the automation affect the manufacturing? Can Automation be introduced at all levels? Justify your statement with examples	L4	1	10
b)	Virtually all industrial devices and processes are governed by standards to various degrees. Why are these standards important? Discuss standards established by IEC and ISO and their applications	L3		10
2.a)	Over many years, Sainsbury company was operating with the same supply chain and the IT system. These systems were outdated. Since they were created long before. So, the new firms in the market had started to overtake Sainsbury in terms of the market share since they had the recent technologies in supply chain. Hence, Sainsbury company decided to go for Automation. Provide an overview to Sainsbury company about various technologies and tools that are available for Automation. Suggest the best technology and tool that the company can adopt with justification	L4		10
b)	The modern and globalized world cannot exist without standards which are supporting cooperation, trade, health, safety, and economic growth etc. In fact, standards exist in almost all aspects of modern life. Highlight the importance of Automation Standards? List some Automation standards used and the role played by them?	L3		10
<b>Section-2</b>				

3.a)	An industrial control network is a system of interconnected equipment used to monitor and control physical equipment in industrial environments. Interconnection is achieved by adopting suitable automation protocols. Compare the protocols used in Automation based on their Application, Strengths and limitations.	L4	2	10
b)	Sensors can be found in almost everything we use on a day-to-day basis. According to the National Science Foundation, "incorporating new sensor technologies, manufacturers can bring new capabilities to their products while improving performance and efficiency. Discuss the sensor technologies used in automation with examples and application.	L3		10
4.a)	The development of newer technologies such as cloud computing, internet of things and cyber-physical systems has brought a new revolution to the manufacturing industry. Communication among devices is one of the key goals of Industry 4.0. One way of achieving this is by using PLC communication protocols. Discuss the features of these PLC communication protocols and their usage in the existing systems with a comparative analysis?	L4		10
b)	A local food and beverage company was working with Horizon Solutions on automation to upgrade projects for one of their key manufacturing facilities. One of the machines looked at upgrading was connected to a conveyor on the packing line. This machine merged three conveyor lines. Also, before packing, one among the lot had to pushed for inspection which is performed by actuators. Discuss different actuators available with their strength and limitations. Suggest a suitable actuator for the above case with justification.	L3		10
<b>Section- 3</b>				
5.a)	A beverage industry has to fill its bottle with beverages at a constant speed of filling 30 bottles per minute. This speed depends on level of the tank due to its head pressure. To maintain this speed, pressure head of the filling tank has to be maintained at a particular head. Suggest a) A Suitable sensor technology, PLC, Drives, Communication Protocol b) A PLC Ladder Program for the above case	L3	3	10
b)	Heated glass tubes are passing in a process line having a particular length which are to be bent. To manufacture fluorescent bulbs, these tubes are to be bent in U-Shape as shown in the diagram. Analyse the diagram and automate this process using Ladder Diagram programming language.	L4		10

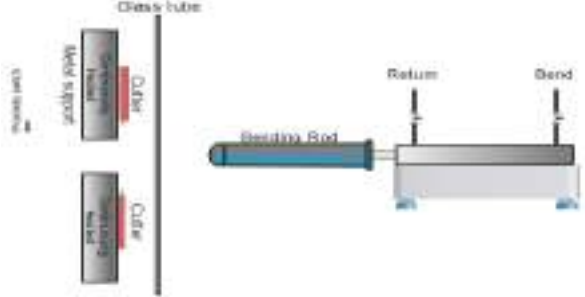
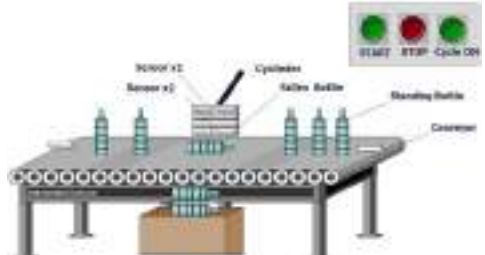
				
6.a)	<p>Heating of the liquid in the tank is to be performed. To heat this liquid, steam flow is controlled. If the temperature is detected less than the set point, increase the steam flow and vice-versa. Select a Suitable sensor technology, PLC, Drives, Communication Protocol Implement automation of this process in PLC using Ladder Diagram programming language.</p>	L3		10
b)	 <p>Analyse the above diagram. Automate the above process in PLC using Ladder Diagram Programming language</p>	L4		10
<b>Section-4</b>				
7.a)	<p>Picking and placing parts or assemblies is often a simple, repetitive, and monotonous task in most industrial manufacturing processes. Especially when it comes to moving large, small, or hard-to-handle parts, automating this function on the factory line with high-speed pick and place robots can provide many benefits to manufacturers. To utilise these benefits, the company has asked programmers to device a Pick and place robot program which will not only provide solution to their problem but also is cost effective. Write a program for the above case assuming the required criteria.</p>	L4	4	10
b)	<p>Inertia Switch company got the full benefits of automation by using effective Grippers in Robots. Discuss different Robot Grippers and Highlight the criteria considered in selection of right type of Robot grippers.</p>	L3		10
8.a)	<p>Pick and place robots used for inspection applications are equipped with advanced vision systems to pick up objects, detect variation and remove defective parts or items by placing them in a designated location. Device a Pick and place robot program for the above case. Assume the required criteria.</p>	L4		10
b)	<p>Develop a program to command a PUMA robot to unload a cylindrical part of 10 mm diameter from machine 1 positioned at point P1 and load the part on machine 2 positioned at P2. The speed of robot</p>	L3		10



	motion is 40 in/s. However, because of safety precautions, the speed is reduced to 10 in/s while moving to a machine for an unloading or loading operation.			
<b>Section-5</b>				
9.a)	One of the key requirements for effective predictive maintenance is a vast quantity of historical and real-time data of machine operations. In the industry 3.0 era, when computers began running traditionally manual operations, this required regular collection and recording of operational data. This was a cumbersome task for the maintenance team. Does the convergence of OT and IT emerge as a solution to this problem? Justify. What is this convergence called? What are the risks and security challenges faced by this convergence?	L3	5	10
b)	Jeff Thornton, product manager at Red Lion Controls pointed five key facets of HMI technology that are changing the common perceptions of HMI. One among them is the protocol. Compare the HMI protocols available and suggest the best one with justification.	L4		10
10.a)	HMI Panel software uses virtual components called Objects. Meters and Graphs are part of these objects. These help in producing simple, human machine interfaces. Using HMI, how is the level of liquid in a container indicated in the form of Bar graphs.	L3		10
b)	With the fourth industrial revolution, Industry 4.0, the Internet of Things has become the hot topic for numerous latest technological development efforts. Although they are merely a subset of modern technologies that are used to improve business processes still, they have their benefits and hence is spreading its wings over the enterprise. Does the introduction of IIOT improve the operational effectiveness? Justify considering all parameters.	L4		10

### Scheme of Evaluation for SEE 2

Sl. No	Description	Marks: 100
<b>Problem statement</b>	<p>Condition: A company is involved in supplying mineral water. They need to continuously meet the customer demand. Hence, have decide to Automate their entire unit. Following conditions were provided by the company</p> <ul style="list-style-type: none"> <li>a) Bottles are to be filled at a constant speed of 30bottles per min to meet the Demand.</li> <li>b) The bottles are to capped and lifted from the conveyor belt and shifted to the packaging process.</li> <li>c) 200 bottles are to be packed in one carton during packaging.</li> <li>d) The cartons are to be labelled with the company's Tag.</li> </ul> <p>Device a fully Automated system with Robots which will satisfy the company's requirement.</p>	
1	Analyze the given Problem Statement	10
2	Selecting suitable sensor technology for the above case,	10

3	Selecting suitable PLC for the above case	10
4	Selecting suitable Drives for the above case,	10
5	Develop and simulate PLC Ladder Program for the above case	20
6	Interface with PLC and execute using suitable communication protocols	30
7	Execution of the same program for different boundary conditions	10
<b>Total</b>		<b>100</b>

## **Heating Ventilation and Air-Conditioning (HVAC)**



**Government of Karnataka**  
**DEPARTMENT OF COLLEGIATE and TECHNICAL EDUCATION**

<b>Program</b>	<b>Mechanical Engineering</b>	<b>Semester</b>	<b>5</b>
<b>Course Code</b>	<b>20ME52I</b>	<b>Type of Course</b>	<b>L:T:P (104:52:312)</b>
<b>Specialization</b>	<b>Heating Ventilation and Air-Conditioning (HVAC)</b>	<b>Credits</b>	<b>24</b>
<b>CIE Marks</b>	<b>240</b>	<b>SEE Marks</b>	<b>160</b>

### Introduction:

Welcome to the curriculum for the Specialisation Pathway - **Heating, Ventilation and Air conditioning (HVAC)**. This specialisation course is taught in Bootcamp mode. Bootcamps are 12 weeks, intense learning sessions designed to prepare you for the practical world – ready for either industry or becoming an entrepreneur.

Human comfort plays a vital role either in industries or at home or in office or Apartment building. This is made possible through regulation of heat, airflow, ventilation, and air conditioning. Comfortable office climate increases the level of productivity and increases morale amongst the workers and employees. Studies on corporate workplace behaviour and employee motivations suggest that workers are more enticed to keep coming to work if their office is properly cooled and/or heated. Having the proper temperature at work is an added advantage for building a solid team at work.

Controlling the temperature of air inside the designated “Air Conditioned” space along with control of moisture, filtration of air and containment of air borne particles, supply of outside fresh air for control of oxygen and carbon dioxide levels in the air-conditioned space, and finally control of the movement of air or draught, is a very desirable factor. These conditions can be achieved using an HVAC system. The need for hands-on workers to implement and service that high tech HVAC systems is growing and henceforth, is the Specialization pathway - **Heating Ventilation and Air-Conditioning (HVAC)**

You will be assisted through the course, with development-based assessments to enable progressive learning. In this course, you’ll learn how to Design and maintain the HVAC systems for domestic and commercial applications that are needed for today’s job market.

Leading to the successful completion of this bootcamp, you shall be equipped to either do an **Internship** in an organisation working on HVAC solution or do a **Project** in the related field. After the completion of your Diploma, you shall be ready to take up roles like a MEP engineer, Utilities engineer, Maintenance engineer etc., and also can become Entrepreneur in the related field and more

This course will teach you about Thermal process, Heat transfer, Psychometry, HVAC load estimation, duct and piping design, Selection of the equipment’s for HVAC system and more. Details of the curriculum is presented in the sections below

## Pre-requisite

Before the start of this specialisation course, you will have prerequisite knowledge gained in the first two years on the following subjects:

1st year -Engineering Mathematics, Communication Skills, Computer Aided Engineering Graphics, Statistics & Analysis, Basic IT Skills, Fundamentals of Electrical and Electronics Engineering, Project Management skills Engineering Materials and Mechanical Workshop

2nd year-Mechanics of Materials, Machine Tool Technology, Manufacturing Process, Fluid Power Engineering, Product Design and Development, Operations Management, CNC Machines and Elements of Industrial Automation

In this year of study, you shall be applying your previous years learning along with specialised field of study into projects and real-world applications.

### Course Cohort Owner

A Course Cohort Owner is a faculty from the core discipline, who is fully responsible for one specialised field of study and the cohort of students who have chosen to study that specialised field of study.

### Guidelines for Cohort Owner

1. Each Specialized field of study is restricted to a Cohort of 20 students which could include students from other relevant programs.
2. One faculty from the Core Discipline shall be the Cohort Owner, who for teaching and learning in allied disciplines can work with faculty from other disciplines or industry experts.
3. The course shall be delivered in boot camp mode spanning over 12 weeks of study, weekly developmental assessments and culminating in a mini capstone.
4. The industry session shall be addressed by industry subject experts (in contact mode/online / recorded video mode) in the discipline only.
5. The cohort owner shall be responsible to identify experts from the relevant field and organize industry session as per schedule.
6. Cohort owner shall plan and accompany the cohort for any industrial visits.
7. Cohort owner shall maintain and document industrial assignments, weekly assessments, practices and mini project.
8. The cohort owner shall coordinate with faculties across programs needed for their course to ensure seamless delivery as per time table
9. The cohort owner along with classroom sessions can augment or use supplementally teaching and learning opportunities including good quality online courses available on platforms like Karnataka LMS, Infosys Springboard, NPTEL, Unacademy, SWAYAM, etc.

**Course outcome:** A student should be able to

<b>C01</b>	<b>Estimate the Heating and cooling Load and Air Flow for an HVAC application</b>
<b>C02</b>	<b>Select Suitable equipment's for an HVAC application</b>
<b>C03</b>	<b>Design the duct and piping's for an HVAC application using suitable Building information Modelling (BIM) software</b>
<b>C04</b>	<b>Provide innovative HVAC solutions for green buildings</b>

## Detailed course plan

Week	C O	P O	Days	1 <sup>st</sup> session (9am to 1 pm)	L	T	P	2 <sup>ND</sup> session (1.30pm to 4.30pm)	L	T	P
1	1		1	<b>Introduction to HVAC</b> Video Presentation on Application of HVAC system in – Residential buildings, Apartments, Office Space, Hotels, Auditorium, Hospitals, Automobiles, Cold storages.				<b>Thermal Principles</b> Concepts of Heat, Sensible Heat, Latent Heat Temperature, Temperature Scale 4 Work, Power, Energy, Enthalpy, Entropy, Specific Heat, Internal energy	3		
	1		2	Perfect Gas – Gas Laws- Charles law, Boyles law, Characteristics Gas Equation  Laws of Thermodynamics- Zeroth Law of Thermodynamics, First Law of Thermodynamics, Second Law of Thermodynamics  Thermodynamic processes- Explain Work done, change in internal energy, heat supplied or rejected for the following processes using P-V and T-S Diagram: Constant Pressure, Constant Volume, Isothermal	4			Thermodynamic processes- Explain Work done, change in internal energy, heat supplied or rejected for the following processes using P-V and T-S Diagram  Adiabatic, Polytropic, Throttling, Free expansion	3		
	1		3	<b>Psychrometry:</b> Psychrometric terms- Dry Air, Moist Air, Saturated Air, Degree of Saturation, Dry Bulb Temperature, Wet Bulb Temperature, Humidity, Absolute Humidity, Relative Humidity, Specific Humidity, Humidity Ratio	4			Psychrometric processes – Sensible heating, Sensible Cooling, Humidification and De-Humidification Use Psychrometric chart and measure properties of air Plot Psychrometric processes using Psychrometric chart.	1		2
	1		4	<b>Human Comfort-</b> Factors affecting human comfort, Comfort parameters, IAQ (Indoor air Quality): Causes & Sources of Indoor Air Quality, Indoor Air Pollutants	4			Demonstrate the Concepts of heat transfer – Conduction, Convection, Radiation (Lab) Fourier’s law of heat transfer- Thermal conductivity- Newton law of cooling - Thermal resistance (Formula’s)	1		2

			Indoor Air Quality Regulations, ASHRAE Guidelines and Standards							
		5	Developmental Weekly Assessment				Assessment Review and corrective action			3
		6	Industry Class on Use of Psychometric Chart, parameters for Human comfort and ASHRAE standards + Industry Assignment			5				
2	1	1	Tutorial (Peer discussion on Industrial assignment)			4	<b>Solar Radiation-</b> Radiation Heat Transfer, Overall Heat Transfer, Heat Capacity, Coefficients for Radiant Heat Transfer	3		
	1	2	SOLAR ANGLES- Basic Solar Angles, Hour Angle and Apparent Solar Time, Angle of Incidence and Solar Intensity (Video Presentation) Solar Radiation for a Clear Sky, Solar Radiation for a Cloudy Sky (Video Presentation) Location, Weather data, Orientation Solar Radiation, U factors (For data Refer ASHRAE Standards)			4	Moisture Migration in Building Materials, Moisture Transfer from the Surface of the Building Envelope, Moisture Transfer in Building Envelopes CONDENSATION IN BUILDINGS- Visible Surface Condensation, Concealed Condensation within the Building Envelope (Video Presentation)	3		
	1	3	THERMAL INSULATION- Basic Materials and Thermal Properties, Moisture Content of Insulation Material, Economic Thickness, Thermal Resistance of Airspaces (Video Presentation)			4	FENESTRATION- Types of Window Glass (Glazing), Optical Properties of Sunlit Glazing (Video Presentation) HEAT ADMITTED THROUGH WINDOWS- Heat Gain for Single Glazing, Heat Gain for Double Glazing (Video Presentation) Selection of Glazing	3		
	1	4	SHADING OF GLASS- Indoor Shading Devices, External Shading Devices, Shading from Adjacent Buildings (Video Presentation)			4	Shading Coefficients, shading coefficients of building envelopes Solar Heat Gain Factors and Total Shortwave Irradiance	3		
		5	Developmental Weekly Assessment				Assessment Review and corrective action			3
		6	Industry Class on Thermal Insulation, Fenestration and Shading of Glass + Industry Assignment			5				



Week	C O	P O	Days	1 <sup>st</sup> session (9am to 1 pm)	L	T	P	2 <sup>ND</sup> session (1.30pm to 4.30pm)	L	T	P
3	1		1	Tutorial (Peer discussion on Industrial assignment)			4	<b>HVAC Load Calculation</b> Explain – Sensible heat gain, Latent heat gain Calculate sensible heat gain through building structure by conduction Calculate heat gain from solar radiation Calculate Solar (Sensible)heat gain through outside walls and roofs			3
	1		2	Explain Sol Air temperature Calculate Solar heat gain through Glass surface Calculate Heat gain through Infiltration Calculate heat gain through Ventilation Calculate heat gain from occupants Calculate Heat gain from Appliances Calculate Heat gain from products	2		2	Calculate Heat gain from lighting equipment's Calculate Heat gain from power equipment's Calculate Heat gain through ducts  Conversion of Tons of Refrigeration (TR) to British Thermal Units (BTU)  Conversion of Tons of Refrigeration (TR) to KW/hr  Conversion of British Thermal Units (BTU) to KW/hr	1		2
	1		3	Estimate HVAC load for a Single storey building plan using E20 or any similar forms. Calculate Air flow in CFM (Supply air, Return Air, Exhaust Air, Fresh Air)					2		5
	1		4	Estimate HVAC load for an office building plan using E20 or any similar forms Calculate Air flow in CFM (Supply air, Return Air, Exhaust Air, Fresh Air)					2		5
			5	CIE 1- Written and practice test				Assessment Review and corrective action			3
			6	Industry Class on HVAC load Calculation + Industry Assignment			5				
4	1		1	Tutorial (Peer discussion on Industrial assignment)			4	Estimate HVAC load for a commercial building using E20 or any similar forms Calculate Air flow in CFM (Supply air, Return Air, Exhaust Air, Fresh Air)			3



			<ul style="list-style-type: none"> <li>a) Compressor – Types (Reciprocating, Centrifugal, Screw, Scroll, Hermetic), Specification from catalogue and Selection Criteria</li> <li>b) Condenser - Types, Specification from catalogue and Selection Criteria</li> <li>c) Evaporator - Types, Specification from catalogue and Selection Criteria</li> <li>d) Expansion Valve - Types, Specification from catalogue and Selection Criteria</li> <li>e) Filter drier - Types, Specification from catalogue and Selection Criteria</li> </ul>	1	3	<p>Discuss Designation system for Refrigerants</p> <p>Discuss Essential and Desirable Properties of a Refrigerant</p> <p>Discuss the Criteria to Select suitable Refrigerant for the refrigeration cycle</p> <p>Discuss the Effect of Refrigerant on Environment (Env Issues)</p>	3		
2		3	<p>ii) <b>Chilled Water cycle</b>            Explain the working principle of Chilled Water cycle in a Centralized AC            Explain and demonstrate the components of Chilled Water cycle</p> <ul style="list-style-type: none"> <li>a) Chillers- Demonstrate the working principle of Chillers, Discuss the types of Chillers-- Air cooled Chillers, Water cooled Chillers, Specification from catalogue and Selection Criteria</li> <li>b) Cooling Tower- Working Principle, Types, Specification from catalogue and Selection Criteria</li> <li>c) Condenser- Working Principle, Types, Specification from catalogue and Selection Criteria</li> <li>d) Water Pump- Working Principle, Types, Specification from catalogue and Selection Criteria</li> </ul>	2	2	<p>iii) <b>Air Distribution System</b></p> <ul style="list-style-type: none"> <li>a) Duct – Types, Material</li> <li>b) Air Handling Unit/ Fan Coil Units - Fan, Grills, Registers, Sealing, Diffuser, Slot Diffusers, Plenum Sealings, Flexible Connectors, Equalizing Grids, Splitter dampers, Control dampers, Anti Smudge rings, Sound and sound controls, Acoustic material (its properties, selection of the same for different HVAC system), filters, VAV Boxes.</li> </ul>	1		2
2		4	<p>iv) <b>Heating cycle</b></p> <ul style="list-style-type: none"> <li>a) Explain Electric Duct Heater- Types- flange type, round adapter option, Slip in Type- Calculation of Power in the heater</li> <li>b) Boiler- Oil or Gas combustion Boiler and Heat exchanger- Furnace heater</li> <li>c) Heat pump</li> </ul>	1	3		1		2

		5	CIE 2- Written and practice test			Assessment Review and corrective action			3
		6	Industry Class- Centralized Air Conditioning System and Industry Assignment		5				
6	2	1	Tutorial (Peer discussion on Industrial assignment)	4		Designing Centralized AC System <b>a) Air Distribution System-</b> <ul style="list-style-type: none"> <li>• Selection criteria for AHU</li> <li>• Placement/Location of AHU's</li> <li>• Fan – Fan Law, Selection Criteria, Calculation of motor power requirement</li> </ul>			3
	2	2	Demonstrate <ul style="list-style-type: none"> <li>• Demonstrate Zone classification- Single Zone and Multi Zone</li> <li>• Shape of the Duct - Circular Rectangular, Square</li> <li>• Duct Materials - Galvanized Iron, Aluminum, Stainless Steel</li> <li>• Thickness of the Duct Sheet</li> <li>• Aspect Ratio (Width to Height)</li> </ul>	4		<ul style="list-style-type: none"> <li>• Duct Designing method- Velocity Reduction method, Equal friction Method, Static Regain Method</li> <li>• Pressure in Ducts- Static Pressure, Dynamic or Velocity pressure, Total pressure</li> </ul>			3
	2	3	Duct classification as per Duct Pressure Design of supply and return duct using ASHRAE standards	1	3	<ul style="list-style-type: none"> <li>• Duct Seal- Class A, Class B, Class C</li> <li>• Distribution System Plans and Symbols- Positive pressure supply, Negative pressure return</li> <li>• Air Terminal Symbol- one way, Two-way, three-way, four -way</li> </ul>	3		
	2	4	b) Designing Water Distribution System- <ul style="list-style-type: none"> <li>• Pipes- Piping materials and its selection</li> <li>• Design of supply and return water pipes</li> <li>• HVAC Piping Insulation</li> <li>• Pumps- Types, Power requirement, Selection using Pump curve</li> </ul>	4		<ul style="list-style-type: none"> <li>• Concepts on Kitchen, Toilet, Basement Ventilation</li> <li>• Concept on Staircase and Lift Pressurization</li> <li>• Concept on HVAC for Clean Rooms</li> </ul>			4

				c) Designing Cooling Coils- <ul style="list-style-type: none"> <li>• Calculate the Diameter of coil</li> <li>• Calculate Number of Coils</li> </ul>								
			5	Developmental Weekly Assessment					• Assessment Review and corrective action			•
			6	Industry Class on Air and Water distribution System in AC and Industry Assignment			5		•			
Week	C O	P O	Days	1 <sup>st</sup> session (9am to 1 pm)	L	T	P	2 <sup>ND</sup> session (1.30pm to 4.30pm)	L	T	P	
7	3		1	Tutorial (Peer discussion on Industrial assignment)		4		<b>Working On BIM (Building Information Modelling) software for Designing an HVAC System.</b>  <b>Exploring the User Interface</b> <ul style="list-style-type: none"> <li>• Model- New</li> <li>• Practice to Navigate the ribbon interface.</li> <li>• Practice to Utilize user interface features.</li> <li>• Practice to Use settings and menus</li> <li>• Practice on Import and reuse existing drawings from other formats.</li> <li>• Practice on Manipulating the properties of parameters</li> </ul>			3	
	3		2	HVAC Cooling and Heating Load Analysis- <ul style="list-style-type: none"> <li>• Creating Spaces</li> <li>• Placing Spaces</li> <li>• Creating a Space Properties Schedule</li> </ul>								

			<ul style="list-style-type: none"> <li>• Modifying Space Properties</li> <li>• Creating Zones</li> <li>• Setting Building Construction Options</li> <li>• Area and Volume Calculations</li> <li>• Color schemes</li> <li>• Performing Heating and Cooling Load Analysis-Load analysis, Weather Data, Outdoor air infiltration, silver spaces</li> <li>• Extracting and interpreting Cooling and Heating Load Report</li> </ul>			2		5
	3	3	Practice Heating and Cooling Load Analysis for building drawings using BIM			1		6
	3	4	Practice Heating and Cooling Load Analysis for building drawings using BIM			1		6
		5	CIE 3- Written and practice test			Assessment Review and corrective action		3
		6	Industry Class on use of BIM software in a Particular Application + Industry Assignment		5			
8	3	1	Tutorial (Peer discussion on Industrial assignment)	4		Creating Logical Systems <ul style="list-style-type: none"> <li>• Create and manage air systems</li> <li>• Configure duct connectors.</li> <li>• Select Mechanical Equipment Components-Air Conditioning / Handling Units, VAV Boxes, Heating and Cooling Elements</li> <li>• Select Duct types and perform Duct Routing</li> </ul>		3
	3	2	Apply/ Practice, the above concepts of logical systems for the given building drawing			1		6
	3	3	Create Piping systems <ul style="list-style-type: none"> <li>• Adjusting Fittings and Extending the Design</li> <li>• Selecting Fittings for Routing Preferences</li> <li>• Choosing Pipe Materials and Sizes</li> <li>• Adjusting the Pipe Sizing Table</li> <li>• Perform Pipe routing</li> <li>• Using Pipe Fitting Controls</li> </ul>		3	Apply/Practice the above concepts of piping systems for the given building drawing		3

			<ul style="list-style-type: none"> <li>Placing Valves</li> <li>Adding Piping Insulation</li> </ul>						
	3	4	Apply/Practice the above concepts of piping systems for the given building drawing				1		6
	3	5	Developmental Weekly Assessment			Assessment Review and corrective action			3
		6	Industry Class on use of BIM software to design Duct and Piping's for a Particular HVAC Application+ Industry Assignment		5				
9	3	1	Tutorial (Peer discussion on Industrial assignment)	4		Design an HVAC system for a Multi storey residential building using BIM software			3
	3	2	Design an HVAC system for a Commercial building using BIM software				1		6
	3	3	Design an HVAC system for an Auditorium using BIM software				1		6
	3	4	Design an HVAC system for a cold storage using BIM software				1		6
		5	CIE 4- Written and practice test			Assessment Review and corrective action			3
		6	Industry class on Safety and Maintenance of an HVAC system + Industry assignment		5				
10	3	1	Tutorial (Peer discussion on Industrial assignment)	4		Building Management System(BMS): <ul style="list-style-type: none"> <li>The BMS system and its components</li> <li>The architecture &amp; different levels of the BMS system</li> <li>The different common protocols used for BMS system and the most used protocol.</li> </ul>	3		
		2	<ul style="list-style-type: none"> <li>The different HVAC systems which can be controlled &amp; monitored by the BMS system</li> <li>Understanding the types of I/O points and their types</li> <li>Define the cable types which are being used with the BMS system</li> </ul>	4		<ul style="list-style-type: none"> <li>The BMS riser diagram and how to read it</li> <li>The different types of documents used with the BMS system submittal</li> </ul>	3		
		3	<ul style="list-style-type: none"> <li>The different benefits of using BMS system in a building</li> </ul>	4		<ul style="list-style-type: none"> <li>Understanding the different methods to connect devices in the BMS system</li> </ul>	3		

				<ul style="list-style-type: none"> <li>The common field devices &amp; sensors used with MEP systems in buildings and how to choose them from the catalogue</li> </ul>			<ul style="list-style-type: none"> <li>The BMS Schematic diagram and how to read it</li> <li>Understanding the Graphics of BMS</li> </ul>				
		4	Virtual Visit on BMS + Industry Assignment		4	Virtual Visit on BMS				3	
		5	Developmental Weekly Assessment			Assessment Review and corrective action				3	
		6	Industry Class on BMS + Industry Assignment		5						
Week	CO	PO	Days	1 <sup>st</sup> session (9am to 1 pm)	L	T	P	2 <sup>ND</sup> session (1.30pm to 4.30pm)	L	T	P
11	2		1	Tutorial (Peer discussion on Industrial assignment)		4		<b>Interpreting the tender Document:</b> An organization is setting up a Multi Training Facility building in its campus. The Director invited tenders for Air conditioning work to be carried out for their building. The HVAC tender requirements for this is given in the Annexure at the end of the curriculum <ul style="list-style-type: none"> <li>Analyse the tender Requirements and specifications</li> <li>Make cohort in to sub teams</li> <li>Sub team as a Vendor, wishes to participate in the tender process</li> <li>Sub team needs to discuss and prepare a tender Response Document</li> <li>Conduct Mock tender bids.</li> </ul> <b>Note:</b> For electrical estimation, use the expertise of electrical faculty. Consult Civil faculty for building drawing issues. Neglect Inspection and Testing data in the document.			3
	2		2	An organization is setting up a Multi Training Facility building in its campus. The Director invited tenders for Air conditioning work to be carried out for their building. The HVAC tender requirements for this are given in the Annexure at the end of the curriculum							7



			<ul style="list-style-type: none"> <li>Analyse the tender Requirements and specifications</li> <li>Make cohort in to sub teams</li> <li>Sub team as a Vendor, wishes to participate in the tender process</li> <li>Sub team needs to discuss and prepare a tender Response</li> <li>Conduct Mock tender bids.</li> </ul> <p><b>Note:</b> For electrical estimation, use the expertise of electrical faculty. Consult Civil faculty for building drawing issues. Neglect Inspection and Testing data in the document.</p>			
2		3	<p>An organization is setting up a Multi Training Facility building in its campus. The Director invited tenders for Air conditioning work to be carried out for their building. The HVAC tender requirements for this are given in the Annexure at the end of the curriculum</p> <ul style="list-style-type: none"> <li>Analyse the tender Requirements and specifications</li> <li>Make cohort in to sub teams</li> <li>Sub team as a Vendor, wishes to participate in the tender process</li> <li>Sub team needs to discuss and prepare a tender Response</li> <li>Conduct Mock tender bids.</li> </ul> <p><b>Note:</b> For electrical estimation, use the expertise of electrical faculty. Consult Civil faculty for building drawing issues. Neglect Inspection and Testing data in the document</p>			7
2		4	<p>An organization is setting up a Multi Training Facility building in its campus. The Director invited tenders for Air conditioning work to be carried out for their building. The HVAC tender requirements for this are given in the Annexure at the end of the curriculum</p> <ul style="list-style-type: none"> <li>Analyse the tender Requirements and specifications</li> <li>Make cohort in to sub teams</li> <li>Sub team as a Vendor, wishes to participate in the tender process</li> <li>Sub team needs to discuss and prepare a tender Response</li> <li>Conduct Mock tender bids.</li> </ul> <p><b>Note:</b> For electrical estimation, use the expertise of electrical faculty. Consult Civil faculty for building drawing issues. Neglect Inspection and Testing data in the document</p> <p>Outcome of this Week is:</p> <ul style="list-style-type: none"> <li>Must be able to interpret the HVAC Drawings</li> <li>Understand the Specifications of the equipment.</li> <li>Select equipment based on Specifications and Requirements along with cost.</li> </ul>			7
		5	CIE 5- Written and practice test		Assessment Review and corrective action	3
		6	Industry Class on Tendering process + Industry assignment		5	

12	4	1	Tutorial (Peer discussion on Industrial assignment)			<b>Green Buildings and HVAC</b> <ul style="list-style-type: none"> <li>• Discuss Green building and its importance in sustainable Planning</li> <li>• Characteristics of green buildings</li> <li>• Demonstrate Life Cycle Assessment</li> </ul>	1	2
	4	2	LEED (Leadership in Energy and Environmental Design) Certification, Requirements, Benefits  Green Building HVAC- Designing for Energy Efficiency: Through Building Simulation (Demo)	2	2	Discuss design Measures to reduce Heat Load and increase energy efficiency of the building with techniques like <ul style="list-style-type: none"> <li>• Solar passive techniques</li> <li>• Building orientation</li> <li>• Proper Shading</li> <li>• Window Wall Ratio</li> <li>• Building Envelope</li> </ul>	3	
	4	3	Strategies adopted in the HVAC system to meet green building requirements- <ul style="list-style-type: none"> <li>• Selection of Chiller</li> <li>• Variable Speed Drives for Pumps</li> <li>• Fans and Compressors</li> <li>• Dedicated Outdoor Air Systems</li> <li>• Supply Air System Control</li> <li>• Demand Control Ventilation</li> <li>• Air to Air Heat Recovery System</li> <li>• Thermal Storage System for Cooling</li> <li>• Gas Fired Chillers</li> </ul> Control cooling tower fans by sensing ambient wet bulb temperature	3	1	<b>Case study on environmental benefits through energy savings in HVAC system</b>	1	2
	4	4	Adding intelligence to HVAC solutions- (Video's) <ul style="list-style-type: none"> <li>• Occupant-based thermal comfort strategies</li> <li>• Decoupling of ventilation and heating/cooling</li> </ul>	2	2	<b>Case studies to demonstrate energy saving potentials from HVAC in Green Buildings</b>		3

			<ul style="list-style-type: none"> <li>Indirect evaporative cooling</li> </ul> <b>A Case Study on Energy Efficient Green Building with New Intelligent Techniques Used in HVAC to Achieve Sustainable Development Goal</b>						
		5	Developmental Weekly Assessment			Assessment Review and corrective action			<b>3</b>
		6	Industry Class on Sustainable HVAC solutions + Industry assignment		<b>5</b>				
<b>13</b>		1	<b>Internship</b> 1. Secondary research on various industries and their operations to identify at least 3 companies along with the areas of work interest and develop an internship plan that clearly highlights expectations from the industry during the internship. 2. Design and develop a cover letter for an internship request to all 3 identified companies and the resume to be submitted to potential companies. 3. Prepare for an internship interview to highlight your interests, areas of study, career aspirations and personnel competence – including the areas of learning you expect to learn during internship.			<b>Project (Internship/Project Total = 40Hrs)</b> 1. Identification of the problem statement (from at least 3 known problems) the students would like to work as part of the project – either as provided by faculty or as identified by the student. Document the impact the project will have from a technical, social and business perspective. 2. Design and develop the project solution or methodology to be used to solve at least one of the problems identified. 3. Prepare a project plan that will include a schedule, WBS, Budget and known risks along with strategies to mitigate them to ensure the project achieves the desired outcome.			

## References

- ASHRAE® HANDBOOK on Heating, Ventilating, and Air-Conditioning APPLICATIONS
- Air Conditioning A practical introduction by David V. Chadderton
- Air Conditioning Applications and Design by W. P. Jones
- Air-Conditioning and Refrigeration by Shan K. Wang and Zalman Lavan
- Air-Conditioning System Design Manual by Walter Grondzik
- General Specifications For Heating, Ventilation & Air-Conditioning (HVAC) Works (2017) published by CPWD
- HANDBOOK OF AIR CONDITIONING AND REFRIGERATION by Shan K. Wang

8. HVAC Equations, Data, and Rules of Thumb by Arthur A. Bell Jr., PE
9. HVAC Systems Testing, Adjusting & Balancing By Sheet Metal And Air Conditioning Contractors' National Association, Inc
10. Fundamentals of HVAC Systems by Robert McDowall, P.
11. A Text Book of Refrigeration and Air conditioning by R S Kurmi and J K Gupta
12. A Text Book of Refrigeration and Air conditioning by C P Arora
13. BIM handbook: A guide to building information modelling for owners, managers, designers, engineers and contractor
14. Building Information Modelling for Dummies by Stefan Mordue
15. A Practical Guide to Adopting BIM in Construction Projects by Prof Bimal Kumar

### CIE and SEE Assessment Methodologies

CIE Assessment	Assessment Mode	Duration In hours	Max Marks
Week 3	CIE 1- Written and practice test	4	30
Week 5	CIE 2- Written and practice test	4	30
Week 7	CIE 3- Written and practice test	4	30
Week 9	CIE 4- Written and practice test	4	30
Week 11	CIE 5- Written and practice test	4	30
	On line Course work (Minimum 10 hours online course with certification from (SWAYAM/NPTEL/Infosys Springboard)		40
	Profile building for Internship / Submission of Synopsys for project work		20
Portfolio evaluation (Based on industrial assignments and weekly developmental assessment) *			30
<b>TOTAL CIE MARKS (A)</b>			<b>240</b>
<b>SEE 1 - Theory exam (QP from BTE) Conducted for 100 marks 3 hrs duration reduced to 60 marks</b>		<b>3</b>	<b>60</b>
<b>SEE 2 - Practical</b>		<b>3</b>	<b>100</b>
<b>TOTAL SEE MARKS (B)</b>			<b>160</b>
<b>TOTAL MARKS (A+B)</b>			<b>400</b>

\* The industrial assignment shall be based on peer-to-peer assessment for a total of 10 marks (on a scale of 1 to 10) and in the event of a group assignment the marks awarded will be the same for the entire group, the developmental assessment will be for a total of 20 marks and based on MCQ/case study/demonstration and such other assignment methods

## Assessment framework for CIE (1 to 5)

Note: Theory to be conducted for 1 hour and practice for 3 hours, total duration of exam – 4 hours

## CIE 1 - Model Question Paper

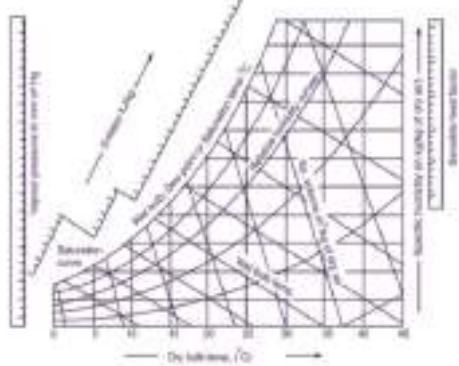
Programme	Mechanical Engineering		Semester	V		
Course	Heating, Ventilation and Air-Conditioning (HVAC )		Max Marks	30		
Course Code	20ME52I		Duration	4 hours		
Name of the course coordinator						
Note: Answer one full question from each section.						
Qn.No	Question		CL L3/L4	CO	PO	Marks
<b>Section-1 (Theory) - 10 marks</b>						
1.a)	<p>What does these lines represent on a Psychrometric chart</p> <ul style="list-style-type: none"> <li>i) Vertical and uniform space lines</li> <li>ii) Curved line</li> <li>iii) Non-Uniformly spaced inclined straight lines</li> <li>iv) Non-Uniformly spaced horizontal lines</li> <li>v) Uniformly spaced inclined straight lines</li> <li>vi) Shading a portion of the psychrometric chart</li> </ul>		L3	1		03
b)	<p>Rajasthan has a unique weather, though the deserts of Rajasthan have shrunk drastically still the Ganganagar district of Rajasthan has similar weather:</p> <ol style="list-style-type: none"> <li>1. Sand storms, which brings a lot of heat and dust.</li> <li>2. Strong Sunlight, which causes extreme day temperature.</li> <li>3. Colder nights, vast difference in the day and night temperature.</li> <li>4. Lots of insects and flies.</li> </ol>		L4	1		07

	Analyse different Glazing methods and suggest a suitable solution to the above problem				
2.a)	Indicate the following Psychometric processes on a Psychometric chart i) Sensible heating ii) Sensible cooling iii) Humidification and dehumidification	L4	1		03
b)	Energy efficiency of buildings is attracting significant attention from the research community as the world is moving towards sustainable buildings design. Shading influences the solar energy on a window and the conveyed energy within the room through the window. Discuss shading phenomenon and its effect in heat load calculations?	L3	1		07
<b>Section-2 (Practical) - 20 marks</b>					
3)	Estimate HVAC load for a building plan given using E20 or any similar forms Also, Calculate Air flow in CFM. The conditions are as follows Inside conditions: 25°C dry bulb, 50 percent RH, $W_i = 0.00992$ kg water/kg air Outside conditions: 43°C dry bulb, 24°C wet bulb, $W_o = 0.0105$ kg water/kg air U-value for wall: 1.75 W/m <sup>2</sup> K U-value for roof: 1.33 W/m <sup>2</sup> K U-value for floor: 1.3 W/m <sup>2</sup> K Effective Temp. Difference (ETD) for wall: 22°C Effective Temp. Difference (ETD) for roof: 26°C U-value for glass: 2.9 W/m <sup>2</sup> K Solar Heat Gain (SHG) of glass: 275 W/m <sup>2</sup> Internal Shading Coefficient (SC) of glass: 0.8 Occupancy: 6 (100 W sensible heat/person) (50 W latent heat/person) Lighting load: 50 W/m <sup>2</sup> of floor area Appliance load: 650 W (Sensible) + 310W(latent) Infiltration: 0.4 Air Changes per Hour Barometric pressure: 101 kPa Note: hfg of water = 2501 kJ/kg.	L4	1		20

					
4)	<p>                     Estimate HVAC load for a building plan given using E20 or any similar forms                      Also, Calculate Air flow in CFM. The conditions are as follows                      Outside conditions 43 C dry bulb, 24 °C wet bulb, density of dry air 1,095 kg/m<sup>3</sup>                      U-value for wall 1.78 W/m<sup>2</sup> K                      U-value for floor 12 W/m<sup>2</sup> K                      U-value for glass 3.12 W/m<sup>2</sup> K                      Cooling load temperature difference (CLTD) for wall 25° C                      Cooling load temperature difference (CLTD) for roof 30 °C                      Solar Heat Gain (SHGF<sub>max</sub>) of glass 300 W/m<sup>2</sup>                      Internal Shading Coefficient (SC) of glass 0.86                      Cooling load factor (CLF) 1.0                      Occupancy 4 people (90 W sensible heat/person) (40 W latent heat person)                      Lighting load 33 W/m<sup>2</sup> of floor area                      Appliance load 600 W (Sensible) 300 W (latent)                      Infiltration rate 8.2125 x 10<sup>9</sup>k/Hr                      Barometric pressure 101 kPa                      Specific heat of moist air (C<sub>pm</sub>) 1.0216 kJ/kgK                      Specific enthalpy of vaporization 2501 kJ/kg                 </p>	L4			20

					
--	--	--	--	--	--

**Note : Theory questions shall be aligned to practical questions**

#### Scheme of Evaluation for Practical question- Section 2

Sl. No	Description	Marks: 20
1	Analyze the given Problem Statement	03
2	Calculate Heat Load for the given drawing using E20 or other forms	10
3	Tabulate the result and provide inference	03
4	Suggest one way to reduce the heating load with justification	04
	<b>Total</b>	<b>20</b>



## Assessment framework for SEE 1 (Theory)

<b>Programme : Mechanical Engineering</b>		<b>Semester: V</b>		
<b>Course : Heating, Ventilation and Air-Conditioning (HVAC)</b>		<b>Max Marks: 100 Marks</b>		
<b>Course Code : 20ME52I</b>		<b>Duration: 3 Hrs</b>		
<b>Instruction to the Candidate:</b> Answer one full question from each section.				
Q.No	Question	CL (L3/L4)	CO	Marks
<b>Section-1</b>				
1.a)	According to statistics, major percentage of the overall business operating cost is spent on staff cost including medical benefit paid for employee. Therefore, promoting health and wellbeing at work not only contributes to employees' active engagement and improved productivity, but also leads to remarkable savings in operating cost for employers. For these reasons, an acceptable indoor environmental quality plays a key role. What comfort parameters need to be considered for maintaining indoor air quality? Discuss.	L4	1	08
b)	An air-conditioned room that stands on a well-ventilated basement measures 3 m wide, 4 m high and 8 m deep. The two 8 m walls contain a double-glazed glass window of size 1.2 m by 1.3 m, mounted flush with the wall with no external shading. There are no heat gains through the other walls other than the ones with windows. Calculate the total latent heat and the total heat from the walls only using E20 or other forms Inside conditions: 25°C dry bulb, 50 percent RH, $W_i = 0.00992$ kg water/kg air Outside conditions: 43°C dry bulb, 24°C wet bulb, $W_o = 0.0105$ kg water/kg air U-value for wall: 1.75 W/m <sup>2</sup> K U-value for roof: 1.33 W/m <sup>2</sup> K U-value for floor: 1.3 W/m <sup>2</sup> K Effective Temp. Difference (ETD) for wall: 22°C Effective Temp. Difference (ETD) for roof: 26°C U-value for glass: 2.9 W/m <sup>2</sup> K Solar Heat Gain (SHG) of glass: 275 W/m <sup>2</sup> Internal Shading Coefficient (SC) of glass: 0.8 Occupancy: 3 (100 W sensible heat/person) (50 W latent heat/person)	L3		12

	Lighting load: 30 W/m <sup>2</sup> of floor area Appliance load: 550 W (Sensible) + 280 W (latent) Infiltration: 0.4 Air Changes per Hour Barometric pressure: 101 kPa Note: hfg of water = 2501 kJ/kg.		
2.a)	Building energy efficiency is an important matter for energy policy at the regional, national and international levels. Several technological techniques and designs for high performance are based on central concepts such as space conditioning, ventilation, daylighting, and solar heat gain control. Does the techniques of Glazing and Shading affect energy efficiency? Justify	L4	08
b)	An air-conditioned room that stands on a well-ventilated basement measures 3 m wide, 3 m high and 6 m deep One of the two 3 m walls faces west and contains a double-glazed glass window of size 1.5 m by 1.5 m, mounted flush with the wall with no external shading. There are no heat gains through the walls other than the one facing east. From the following information Inside conditions 25 °C dry bulb, 50% relative humidity Outside conditions 43 C dry bulb, 24 °C wet bulb, density of dry air 1,095 kg/m <sup>3</sup> U-value for wall 1.78 W/m <sup>2</sup> K U-value for floor 12 W/m <sup>2</sup> K U-value for glass 3.12 W/m <sup>2</sup> K Cooling load temperature difference (CLTD) for wall 25° C Cooling load temperature difference (CLTD) for roof 30 °C Solar Heat Gain (SHGF <sub>max</sub> ) of glass 300 W/m <sup>2</sup> Internal Shading Coefficient (SC) of glass 0.86 Cooling load factor (CLF) 1.0 Occupancy 4 people (90 W sensible heat/person) (40 W latent heat person) Lighting load 33 W/m <sup>2</sup> of floor area Appliance load 600 W (Sensible) 300 W (latent) Infiltration rate 8.2125 x 10 <sup>9</sup> k/Hr Barometric pressure 101 kPa Specific heat of moist air (C <sub>pm</sub> ) 1.0216 kJ/kgK Specific enthalpy of vaporization 2501 kJ/kg Since the room stands on a well-ventilated basement, assume the conditions in the basement to be the same as that of the outside. Also, since the floor is not exposed to solar radiation assume the Cooling load temperature difference for the floor as the temperature difference between the outdoor and indoor. Calculate the sensible, latent and total heat gains using E20 or other forms	L3	12
<b>Section-2</b>			

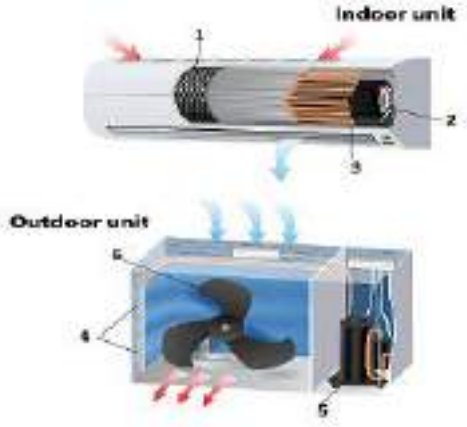
3.a)	 <p style="text-align: center;">Fig (a)</p>	A Split Airconditioning system is shown in Fig (a). Identify the components indicated by numbers. What are the functions of these components? How is Air conditioned happening in this system?	L3	2	08
b)	Homeowners were looking for more comfort than they were getting from window air conditioners in the summer, and they were tired of having to install and store the heavy, bulky units every year. They needed ductless HVAC system to solve their problem. Compare different ductless air-conditioning systems available and suggest a suitable one for this case with justification:		L4		12
4.a)	HVAC systems are provided with Cooling towers and Condensers. What is the role played by these components? How do they work in an Air-Conditioning system?		L3		08
b)	You have been approached by Walthamstow Academy as they have recognised the need for an integrated air conditioning solution for their flagship school. The requirement was to provide the most efficient method of cooling mixed-use rooms including offices, classrooms, laboratories and IT Suites over three floors and a 12,000 square feet footprint. Compare different Air-Conditioners and suggest a suitable one to solve their problem with justification:		L4		12
<b>Section- 3</b>					
5.	Heating and Cooling Load is required to be analysed for the building drawing shown in Fig (a) for the following conditions Inside conditions: 25°C dry bulb, 50 percent RH, $W_i = 0.00992$ kg water/kg air Outside conditions: 43°C dry bulb, 24°C wet bulb, $W_o = 0.0105$ kg water/kg air U-value for wall: 1.75 W/m <sup>2</sup> K U-value for roof: 1.33 W/m <sup>2</sup> K U-value for floor: 1.3 W/m <sup>2</sup> K Effective Temp. Difference (ETD) for wall: 22°C		L4	1	20

	<p>Effective Temp. Difference (ETD) for roof: 26°C                  U-value for glass: 2.9 W/m<sup>2</sup> K                  Solar Heat Gain (SHG) of glass: 275 W/m<sup>2</sup>                  Internal Shading Coefficient (SC) of glass: 0.8                  Occupancy: 6 (100 W sensible heat/person) (50 W latent heat/person)                  Lighting load: 50 W/m<sup>2</sup> of floor area                  Appliance load: 650 W (Sensible) + 310W(latent)                  Infiltration: 0.4 Air Changes per Hour                  Barometric pressure: 101 kPa Note: hfg of water = 2501 kJ/kg.</p>  <p style="text-align: center;">Fig(a)</p>			
6	<p>Three thousand lug boxes of apples are stored at 35° F in a storage cooler 50 ft x 40 ft x 10 ft. The apples enter the cooler at a temperature of 90° F and at the rate of 200 lugs per day each day for the 15 day harvesting period. The walls including floor and ceiling are constructed of 1 in. boards on both sides of 2x4 studs and are insulated with 3<sup>5</sup>/<sub>8</sub> in. of rock wool. All of the walls are shaded and the ambient temperature is 85° F. The average weight of apples per lug box is 59 lb. The lug boxes have an average weight of 4.5 lb and a specific heat value of 0.60 Btu/lb/° F. Determine the average hourly cooling load based on 16 hr operating time for the equipment.</p>	L4		20
<b>Section-4</b>				
7.a)	<p>The green building is an eco-friendly segment, since it depends on the essential principles - "REDUCE, REUSE and RECYCLE. Does sustainable planning help in adopting these principles? Justify with illustrations.</p>	L3	4	10

b)	Green Building movement has been driving the HVAC community for now about a decade to look at innovative solutions for reducing the energy cost and better IEQ (Indoor Environment Quality). The ventilation and air conditioning system which is a key component in green building design is on the verge of a paradigm shift. This shift is providing designers opportunities to explore energy efficient designs. The new initiatives such as intelligent HVAC systems are aimed at improving health, comfort and productivity. Discuss with comparison various intelligent HVAC methods that are available and suggest suitable that can be adopted to reduce the energy consumption. Illustrate with examples.	L4		10
8.a)	LEED (Leadership in energy and Environmental Design) is the most widely used green building rating system in the world. LEED certification is a globally recognized symbol of sustainability achievement and leadership. What requirement should the building satisfy to obtain LEED certificate? How does this certificate help HVAC in green buildings?	L3		10
b)	In a study conducted by Howarth, it was found that energy consumption (EC) in Saudi Arabia is very different in summer and winter. Taking into account 60 GW for summer and 23 GW for winter, it is clear that owing to using AC throughout the country, the summer electricity consumption is 2.6 times that of winter. Adopt suitable techniques to reduce heat load and improve the energy efficiency of the building by comparing the various techniques and hence provide solutions to this problem.	L4		10
<b>Section-5</b>				
9.a)	A two-story house; with the living room, kitchen, and hallway located on the ground floor, while 3 bedrooms, and a smaller living room are located upstairs. The upper portion of the house is mostly occupied during the night only. It makes sense then to establish zones in such a situation. Suggest suitable zoning for the above case to provide solution by comparing the zoning methods adopted in HVAC systems.	L4	2	10
b)	Piping's play a critical role in HVAC systems. While designing Piping system, losses in pipes are to be considered. Discuss various losses in pipe and methods to overcome these losses?	L3		10
10.a)	Ductwork is an essential part of the HVAC system. There are so many ducts material options in the market, and each serves a different purpose. The option you choose may be decided based on needs such as insulation, noise reduction, moisture and condensation, and build-up. Discuss different Duct materials for HAVC system and their application.	L3		10

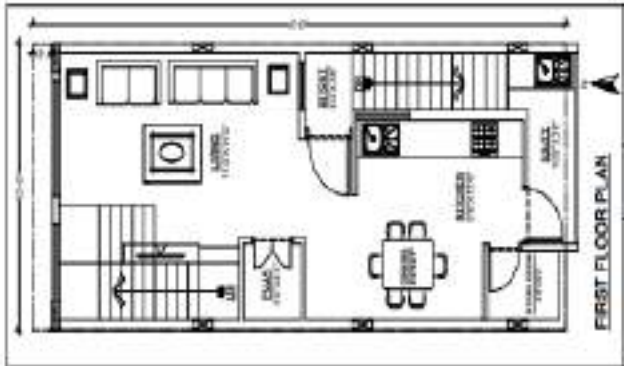
b)		Analyse the given drawing and select suitable Air distribution system and justify.	L4		10
----	---	--	----	--	----

**Scheme of Evaluation for SEE 2**

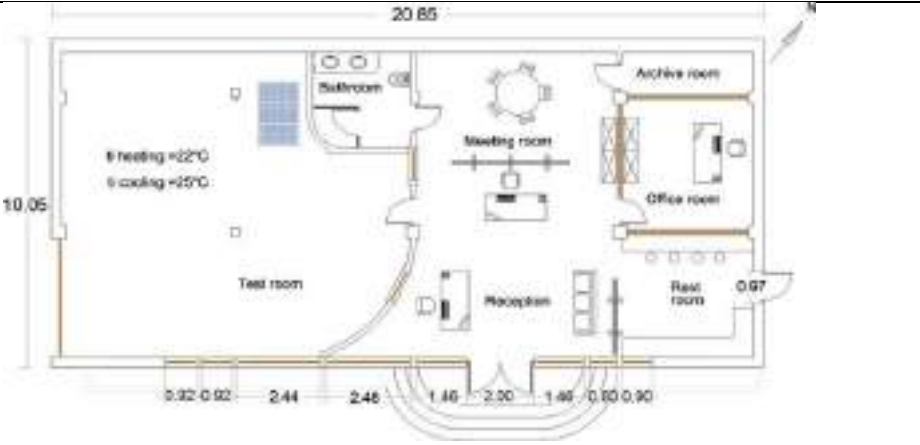
Sl. No	Description	Marks	
<p><b>Problem statement</b></p>		<p><b>Design an HVAC system for the given office space using suitable BIM software</b></p> <p><b>Note:</b> Necessary Psychometric, building data and location must be provided by the examiner</p>	100
1	Heating and cooling load calculation using E20 forms or any other forms	20	

2	Apply logical systems for the given office space drawing	30
3	Apply piping systems for the given office space drawing	30
4	Innovating methods to reduce the Heating and cooling Load	20
<b>Total</b>		<b>100</b>

# **Advanced Manufacturing Technologies**





**Government of Karnataka**  
**DEPARTMENT OF COLLEGIATE and TECHNICAL EDUCATION**

<b>Program</b>	<b>Mechanical Engineering</b>	<b>Semester</b>	<b>5</b>
<b>Course Code</b>	<b>20ME53I</b>	<b>Type of Course</b>	<b>L: T:P (104:52:312)</b>
<b>Specialization</b>	<b>Advanced Manufacturing Technologies</b>	<b>Credits</b>	<b>24</b>
<b>CIE Marks</b>	<b>240</b>	<b>SEE Marks</b>	<b>160</b>

**Introduction:** Welcome to the curriculum for the Specialisation Pathway – **ADVANCED MANUFACTURING Technologies**. This specialisation course is taught in Bootcamp mode. Bootcamps are 12 weeks, intense learning sessions designed to prepare you for the practical world – ready for either industry or becoming an entrepreneur. You will be assisted through the course, with development-based assessments to enable progressive learning.

Conventional manufacturing processes, have their inherent drawbacks which cannot be eliminated. In other words, due to their technological constraints, it is not always feasible to produce various components in terms of geometry, dimension, and strength, etc. CNC machining can have difficulties in machining complex shapes due to tool accessibility. High temperature and tool wear are other considerations while machining hard materials.

Advancement in manufacturing processes has drawn preminent interest from researchers and industry. This makes the process of manufacturing more productive and highly efficient. Advancement of technology has been done by several approaches to combine different manufacturing processes with similar objectives of increasing material removal rate, improving surface integrity, reducing tool wear, reducing production time, and extending application areas. A combination of different processes opens new opportunities and applications for manufacturing various components that are not able to be produced economically by processes on their own.

In this course, you'll learn how to Select a suitable materials and Processes in Advanced manufacturing in accordance with the present Manufacturing Scenario.

Leading to the successful completion of this bootcamp, you shall be equipped to either do an **Internship** in an organisation working on Advanced Manufacturing solution or do a **Project** in the related field. After the completion of your Diploma, you shall be ready to take up Production Supervisor, Engineer, Production Manager and also can become Entrepreneur in the related field and more

This course will teach you about Advanced materials, Advanced Processes, Advanced Manufacturing, Advanced Inspection and Diagnostics. Details of the curriculum is presented in the section below

## **Pre-requisite**

Before the start of this specialisation course, you will have prerequisite knowledge gained in the first two years on the following subjects:

1st year -Engineering Mathematics, Communication Skills, Computer Aided Engineering Graphics, Statistics & Analysis, Basic IT Skills, Fundamentals of Electrical and Electronics Engineering, Project Management skills Engineering Materials and Mechanical Workshop

2nd year-Mechanics of Materials, Machine Tool Technology, Manufacturing Process, Fluid Power Engineering, Product Design and Development, Operations Management, CNC Machines and Elements of Industrial Automation

In this year of study, you shall be applying your previous years learning along with specialised field of study into projects and real-world applications.

### Instruction to course coordinator

1. Each Pathway is restricted to a Cohort of 20 students which could include students from other relevant programs.
2. Single faculty shall be the Cohort Owner.
3. This course shall be delivered in boot camp mode
4. The industry session shall be addressed by (in contact mode/online / recorded video mode) industry experts only.
5. The cohort owner shall identify experts from the relevant field and organize industry session as per schedule.
6. Cohort owner shall plan and accompany the cohort for industrial visits.
7. Cohort owner shall maintain and document the industrial assignments and weekly assessments, practices and mini project.
8. The cohort owner shall coordinate with faculties across programs needed for their course to ensure seamless delivery as per time table
9. The cohort owner along with classroom, can augment or use for supplementally teaching, on line courses available although reliable and good quality online platforms like Karnataka LMS, Infosys Springboard, NPTEL, Unacademic, SWAYAM, etc.
10. Cohort owner shall guide the cohort for the execution of mini project

**Course Outcomes:** At the end of the Course, the student will be able to:

<b>CO-01</b>	Select suitable Non- Conventional Machining process with Process parameter and machine the component as per the given drawing.
<b>CO-02</b>	Prepare a given component by using 3D Printing manufacturing process.
<b>CO-03</b>	Check the components for Functionality and conformance to defined standards using Measuring instruments.
<b>CO-04</b>	Integrate Automation and IIOT in Advanced Manufacturing

## Detailed course plan

Week	C O	P O	Days	1 <sup>st</sup> session (9am to 1 pm)	L	T	P	2 <sup>ND</sup> session (1.30pm to 4.30pm)	L	T	P
1	1		1	Present an overview on Conventional manufacturing process starting from procurement of raw materials to finished product and delivery to the customer			4	<p>Present a Video on components manufactured in Modern manufacturing Industries</p> <p>Virtual tour on modern industries such as automobile sector, aviation sector, Fast Moving Consumer Goods (FMCG) sector etc</p> <p>Present an Overview on Need, Classification and Features of Advanced manufacturing technologies with respect to</p> <ul style="list-style-type: none"> <li>• Materials</li> <li>• Manufacturing Processes</li> <li>• Automation</li> <li>• Inspection and Quality</li> <li>• Information Technology</li> </ul>	2		1
	1		2	<ul style="list-style-type: none"> <li>• Discuss the Advancement in material technology leading to advancement in Manufacturing Process</li> <li>• Discuss the Properties and Characteristic features of Composite materials, Steel Alloys, Aluminum alloys, Polymers, Glass, Ceramics, Super Alloys</li> </ul>	4			<ul style="list-style-type: none"> <li>• Discuss and record the Application of these materials in making components used in Aircraft, Cutting tools, high temperature applications, Automobiles etc.,</li> </ul>	2		1
	1		3	<ul style="list-style-type: none"> <li>• Discuss the Need and significance of non-Conventional machining process</li> <li>• Discuss classification of non-Conventional machining process</li> <li>• Explain the Principle, Construction and Working of Ultrasonic Machining Process (USM) using Videos</li> </ul>	2		2	<ul style="list-style-type: none"> <li>• Explain Tool materials and their Properties, Tool wear Rate, Abrasive material and Slurry, Work materials used in USM</li> <li>• Discuss the Characteristics of USM</li> <li>• Calculate Metal removal Rate</li> </ul>	2		1

			<ul style="list-style-type: none"> <li>Explain different Transducers used in USM and Present them using Videos</li> <li>Discuss the criteria considered for selecting the right type of transducer for the given application</li> <li>Explain the Process Parameters involved in USM</li> </ul>				<ul style="list-style-type: none"> <li>Present a Video on the Applications of USM</li> </ul>			
	1	4	Prepare a job using USM (ON Campus/ OFF Campus) <ul style="list-style-type: none"> <li>Study the component drawing</li> <li>Select the process Parameter</li> <li>Perform the process</li> <li>Check for dimensional accuracies</li> </ul>					3		4
		5	Developmental Weekly Assessment				Assessment Review and corrective action			3
		6	Industry Class - Use Cases on USM + Industry Assignment			5				
2	1	1	Tutorial (Peer discussion on Industrial assignment)		4		<ul style="list-style-type: none"> <li>Explain Principle, Construction and Working of Electro Chemical Machining (ECM) using videos</li> <li>Discuss the Types of Electrolytes and its selection for different materials</li> </ul>	2		1
	1	2	<ul style="list-style-type: none"> <li>Discuss types of Tool material, their properties and selection</li> <li>Discuss the factors governing surface finish in ECM</li> <li>Discuss the Characteristics of ECM</li> </ul>	2		2	<ul style="list-style-type: none"> <li>Calculate Metal Removal rate</li> <li>Present a Videos on the Application of ECM</li> </ul>			3
	1	3	<ul style="list-style-type: none"> <li>Explain Principle, Construction and Working of Chemical Machining (CM) using videos</li> <li>Types of Chemical machining- Milling, Blanking, Engraving</li> </ul>	4			<ul style="list-style-type: none"> <li>Steps involved in Chemical machining- Clean, Mask, Scribe, Etch, Demask</li> <li>Commonly used Etchants-</li> <li>Applications of Chemical Machining</li> </ul>	2		1
	1	4	Prepare a job using ECM (ON Campus/ OFF Campus) <ul style="list-style-type: none"> <li>Study the component drawing</li> </ul>			4	Prepare a job by Chemical Machining (ON Campus/ OFF Campus) <ul style="list-style-type: none"> <li>Study the component drawing</li> </ul>			4

			<ul style="list-style-type: none"> <li>Select the process Parameter</li> <li>Perform the process</li> <li>Check for dimensional accuracies</li> </ul>				<ul style="list-style-type: none"> <li>Select the process Parameter</li> <li>Perform Clean, Mask, Scribe, Etch, Demask</li> <li>Check for dimensional accuracies</li> </ul>			
		5	Developmental Weekly Assessment				Assessment Review and corrective action			3
		6	Industry Class - Use Cases on ECM + Industry Assignment			5				
3	1	1	Tutorial (Peer discussion on Industrial assignment)		4		<ul style="list-style-type: none"> <li>Explain the Principle, Construction and Working of Electrical Discharge Machining (EDM) using videos</li> <li>Discuss types and functions of Dielectric Fluid</li> </ul>	1		2
	1	2	<ul style="list-style-type: none"> <li>Discuss types of Tool material, their properties and selection</li> <li>Calculate Metal Removing Rate- Factors affecting MRR</li> </ul>	2		2	<ul style="list-style-type: none"> <li>Explain the Process Parameters involved in EDM</li> <li>Discuss the Characteristics of EDM</li> </ul>	3		
	1	3	<ul style="list-style-type: none"> <li>Discuss and Present a Video on spark Generating circuit/Process used in EDM</li> <li>Applications of EDM</li> </ul>	1		3	<ul style="list-style-type: none"> <li>Explain the Principle, Construction and Working of Wire cut electro-Discharge Machining (WCEDM) using videos</li> <li>Discuss the Features of WCEDM</li> </ul>	1		2
	1	4	Prepare a job using - EDM (ON Campus/ OFF Campus) <ul style="list-style-type: none"> <li>Study the component drawing</li> <li>Select the process Parameter</li> <li>Perform the process</li> <li>Check for dimensional accuracies</li> </ul>			4	Prepare a job using - WCEDM (ON Campus/ OFF Campus) <ul style="list-style-type: none"> <li>Study the component drawing</li> <li>Select the process Parameter</li> <li>Perform the process</li> <li>Check for dimensional accuracies</li> </ul>			3
		5	CIE 1- Written and practice test				Assessment Review and corrective action			3
		6	Industry Class - Use cases on EDM/WCEDM+ Industry Assignment			5				

Week	C O	P O	Day s	1 <sup>st</sup> session (9am to 1 pm)	L	T	P	2 <sup>ND</sup> session (1.30pm to 4.30pm)	L	T	P
------	-----	-----	-------	---------------------------------------	---	---	---	--	---	---	---

4	1	1	Tutorial (Peer discussion on Industrial assignment)		4	<ul style="list-style-type: none"> <li>Explain the Principle, Construction and Working of Electron Beam Machining (EBM) using videos</li> </ul>		3
	1	2	<ul style="list-style-type: none"> <li>Explain the Process Parameters that influence Beam intensity</li> <li>Explain the Process Parameters that influence Metal Removal Rate</li> </ul>	3		<ul style="list-style-type: none"> <li>Discuss the Characteristics of EBM</li> <li>Calculate Metal Removal Rate</li> <li>Present a Video on the Applications of EBM</li> </ul>	2	1
	1	3	<ul style="list-style-type: none"> <li>Explain the Principle, Construction and Working of Laser Beam Machining (LBM) using videos</li> <li>Discuss different Laser materials used in LBM</li> </ul>	1	3	<ul style="list-style-type: none"> <li>Discuss the Characteristics of LBM</li> <li>Calculate Metal Removal Rate</li> <li>Present a Video on the Applications of LBM</li> </ul>		3
	1	4	Prepare a job using EBM (ON Campus/ OFF Campus) <ul style="list-style-type: none"> <li>Study the component drawing</li> <li>Select the process Parameter</li> <li>Perform the process</li> <li>Check for dimensional accuracies</li> </ul>		4	Prepare a job using LBM (ON Campus/ OFF Campus) <ul style="list-style-type: none"> <li>Study the component drawing</li> <li>Select the process Parameter</li> <li>Perform the process</li> <li>Check for dimensional accuracies</li> </ul>		4
		5	Developmental Weekly Assessment			Assessment Review and corrective action		3
		6	Industry Class - use cases on EBM, LBM, PAM + Industry Assignment		5			
5	2	1	Tutorial (Peer discussion on Industrial assignment)		4	<ul style="list-style-type: none"> <li>Explain the General Overview on Additive Manufacturing (AM)</li> <li>Present a Video on the evolution of AM, Need, Benefits</li> <li>Present a Video on components made using AM</li> </ul>	1	2
	2	2	Additive Manufacturing Technologies (AM)- Explain and Demonstrate the Additive Manufacturing Techniques- Liquid Based Additive Manufacturing 1.1 Melting 1.1.1 Fusion Deposit Modelling 1.2 Polymerization	2	2	3.0 Powder based Additive Manufacturing 3.1 Melting 3.1.1 Selective Laser Sintering 3.1.2 Electron Beam Sintering 3.1.3 Laser Engineered Net Shaping 3.2 Binding 3.2.1 3 - Dimensional Printing	1	2

			1.2.1 Stereolithography 1.2.2 Poly jet 2.0 Solid Based Additive Manufacturing 2.1 Laminated object manufacturing				3.2.2 Pro Metal (Binder Jetting)				
	2		3	Discuss the Bio-Medical, Aviation, Automobile Application of Additive Manufacturing			4	<b>Materials used in additive manufacturing-</b> Discuss the Properties and Applications of Additive manufacturing materials- <ul style="list-style-type: none"> <li>• Ceramics</li> <li>• Plastics: Acrylonitrile Butadiene Styrene (ABS), Polylactide (PLA), Polyethylene Terephthalate (PET), Polycarbonate (PC)</li> <li>• Polymers</li> </ul>	2		1
	2		4	Discuss the Properties and Applications of Additive manufacturing materials- <ul style="list-style-type: none"> <li>• Metals and alloys- Cobalt based Alloys, Aluminum based Alloys, Nickel based Alloys, Stainless steel, Titanium alloys</li> </ul>	3			Discuss the Properties and Applications of Additive manufacturing materials- <ul style="list-style-type: none"> <li>• Composites- Polymer base, Metal based, Ceramic based</li> <li>• Smart materials- Shape memory Polymer and Alloys</li> </ul>	3		
			5	CIE 2- Written and practice test				Assessment Review and corrective action			3
			6	Industry Class - Use case on Additive manufacturing techniques + Industry Assignment			5				

6	2		1	Tutorial (Peer discussion on Industrial assignment)		4		Binding Mechanisms/Techniques- 1) Discuss on Chemical induced Binding <ul style="list-style-type: none"> <li>• Reactive binding</li> <li>• Polymerization</li> </ul>	1		2
	2		2	2) Discuss on Secondary phase assisted binding <ul style="list-style-type: none"> <li>• Adhesive Additives</li> <li>• Evaporation and Hydration Binding</li> <li>• Liquid Phase Sintering: In-Process, Post Process infiltration</li> </ul>	1	2	3) Liquid Fusion <ul style="list-style-type: none"> <li>• Low Viscous flow</li> <li>• Melting: Partial Melting, Full Melting</li> </ul> 4) Solid State Sintering	1		2	

	2	3	<b>Explain Generic AM Process</b> <ol style="list-style-type: none"> <li>1. 3D CAD Modelling</li> <li>2. STL File Conversion</li> <li>3. File transfer to machine</li> <li>4. Machine Set up</li> <li>5. Part building</li> <li>6. Part Removing</li> <li>7. Post- Process</li> </ol>	3	<ul style="list-style-type: none"> <li>• Introduction to 3 - D Printing</li> <li>• Discuss and demonstrate the working principle and Construction of 3-D Printing Machine</li> <li>• Interface CAD Software with Machine</li> <li>• 3-D Scanning and transferring the file to 3-D Printing machine</li> </ul>	3	
	2	4	Develop an AM Process required to produce the given Component on a 3-D Printing machine <ul style="list-style-type: none"> <li>• Prepare a Solid model and convert to STL File</li> <li>• Select a suitable material for the given model</li> <li>• Perform Machine setting and upload STL file</li> <li>• Feed the Raw material</li> <li>• Develop the Model and check for accuracies</li> </ul>			2	5
		5	Developmental Weekly Assessment		Assessment Review and corrective action		3
		6	Industry Class - Use case on prototype models prepared on 3-D Printing +Industry Assignment	5			
7	2	1	Tutorial (Peer discussion on Industrial assignment)	4	Develop an AM Process required to produce the given Component on a 3-D Printing machine <ul style="list-style-type: none"> <li>• Prepare a Solid model and convert to STL File</li> <li>• Select a suitable material for the given model</li> <li>• Perform Machine setting and upload STL file</li> <li>• Feed the Raw material</li> <li>• Develop the Model and check for accuracies</li> </ul>	3	
	2	2	Develop an AM Process required to produce the given Component on a 3-D Printing machine			2	5



				<ul style="list-style-type: none"> <li>• Prepare a Solid model and convert to STL File</li> <li>• Select a suitable material for the given model</li> <li>• Perform Machine setting and upload STL file</li> <li>• Feed the Raw material</li> <li>• Develop the Model and check for accuracies</li> </ul>							
2		3	Develop an AM Process required to produce the given Component on a 3-D Printing machine	<ul style="list-style-type: none"> <li>• Prepare a Solid model and convert to STL File</li> <li>• Select a suitable material for the given model</li> <li>• Perform Machine setting and upload STL file</li> <li>• Feed the Raw material</li> <li>• Develop the Model and check for accuracies</li> </ul>	2					5	
2		4	Develop an AM Process required to produce the given Component on a 3-D Printing machine	<ul style="list-style-type: none"> <li>• Prepare a Solid model and convert to STL File</li> <li>• Select a suitable material for the given model</li> <li>• Perform Machine setting and upload STL file</li> <li>• Feed the Raw material</li> <li>• Develop the Model and check for accuracies</li> </ul>	2					5	
		5	CIE 3- Written and practice test					Assessment Review and corrective action			3
		6	Industry Class on Reverse engineering and Modelling + Industry Assignment			5					

Week	C O	P O	Days	1 <sup>st</sup> session (9am to 1 pm)	L	T	P	2 <sup>ND</sup> session (1.30pm to 4.30pm)	L	T	P
8	2		1	Tutorial (Peer discussion on Industrial assignment)		4		Develop an AM Process required to produce the given Component on a 3-D Printing machine <ul style="list-style-type: none"> <li>• Prepare a Solid model and convert to STL File</li> <li>• Select a suitable material for the given model</li> <li>• Perform Machine setting and upload STL file</li> </ul>	3		

							<ul style="list-style-type: none"> <li>• Feed the Raw material</li> <li>• Develop the Model and check for accuracies</li> </ul>			
	2		2	Develop an AM Process required to produce the given Component on a 3-D Printing machine			<ul style="list-style-type: none"> <li>• Prepare a Solid model and convert to STL File</li> <li>• Select a suitable material for the given model</li> <li>• Perform Machine setting and upload STL file</li> <li>• Feed the Raw material</li> <li>• Develop the Model and check for accuracies</li> </ul>	2		5
	2		3	Develop an AM Process required to produce the given Component on a 3-D Printing machine			<ul style="list-style-type: none"> <li>• Prepare a Solid model and convert to STL File</li> <li>• Select a suitable material for the given model</li> <li>• Perform Machine setting and upload STL file</li> <li>• Feed the Raw material</li> <li>• Develop the Model and check for accuracies</li> </ul>	2		5
	2		4	Develop an AM Process required to produce the given Component on a 3-D Printing machine			<ul style="list-style-type: none"> <li>• Prepare a Solid model and convert to STL File</li> <li>• Select a suitable material for the given model</li> <li>• Perform Machine setting and upload STL file</li> <li>• Feed the Raw material</li> <li>• Develop the Model and check for accuracies</li> </ul>	2		5
			5	Developmental Weekly Assessment			Assessment Review and corrective action			3
			6	Industry Class -Use case on AM + Industry Assignment		5				
9	3		1	Tutorial (Peer discussion on Industrial assignment)		4	Discuss Latest Technologies used in Inspection and Quality control	3		

	3		2	Perform measurement with desired accuracy to check the components for Functionality and conformance to defined standards using different instruments like Vernier caliper, Vernier height gauge, Micrometer, Depth Gauge, Bevel Protractor, Sine bar, Dial Indicator				2		5
	3		3	Perform measurement with desired accuracy to check the components for Functionality and conformance to defined standards using different instruments like Vernier caliper, Vernier height gauge, Micrometer, Depth Gauge, Bevel Protractor, Sine bar, Dial Indicator				2		5
	3		4	Demonstrate the construction and working Principle of Profile Projector Check the Dimensional Accuracies of the Models using Profile Projector				4		3
			5	CIE 4- Written and practice test				Assessment Review and corrective action		3
			6	Industry Class on used cases on Inspection and Quality control + Industry Assignment			5			

<b>10</b>	3		1	Tutorial (Peer discussion on Industrial assignment)		4		Demonstrate the construction and working Principle of Co-Ordinate Measuring Machines (CMM) using videos.	3		
	3		2	Check the Dimensional Accuracies of the Models using CMM for different Components (ON Campus/ OFF Campus)					2	5	
	3		3	Check the Dimensional Accuracies of the Models using CMM for different Components (ON Campus/ OFF Campus)					2	5	
	3		4	Discuss and Demonstrate different Non-Destructive testing Methods (ON Campus/ OFF Campus) <ul style="list-style-type: none"> <li>• Radiography Testing</li> <li>• Ultrasonic Testing</li> <li>• Magnetic Particle Testing</li> </ul>			4	Discuss and Demonstrate different Non-Destructive testing Methods (ON Campus/ OFF Campus) <ul style="list-style-type: none"> <li>• Penetrant Testing</li> <li>• Visual Testing</li> <li>• Electromagnetic testing</li> </ul>	1	2	
			5	Developmental Weekly Assessment				Assessment Review and corrective action			3
			6	Industry Class on Non-Destructive testing + Industry Assignment			5				

Week	C O	P O	Days	1 <sup>st</sup> session (9am to 1 pm)	L	T	P	2 <sup>ND</sup> session (1.30pm to 4.30pm)	L	T	P
11	4		1	Tutorial (Peer discussion on Industrial assignment)		4		Discuss the Role of Automation in Advanced Manufacturing Process Present an Overview on the Levels of Automation-	3		

							<ul style="list-style-type: none"> <li>• Device level</li> <li>• Machine Level</li> <li>• Cell Level</li> <li>• Plant Level</li> <li>• Enterprise Level</li> </ul> Role of CAM (Computer Aided Manufacturing) in Advanced Manufacturing Role of CAPP (Computer Aided Process Planning) in Advanced Manufacturing				
4		2	Material handling in Advanced Manufacturing: <ul style="list-style-type: none"> <li>a) Automated Guided Vehicle (AGV)-                             <ul style="list-style-type: none"> <li>• Overview on AGV</li> <li>• Working Principle</li> <li>• Applications of AGV's</li> <li>• Types of AGV</li> <li>• AGV Navigation</li> </ul> </li> </ul>			4	<ul style="list-style-type: none"> <li>b) Automated storage and Retrieval System (AS/RS)                             <ul style="list-style-type: none"> <li>• Overview on AS/RS</li> <li>• Working Principle</li> <li>• Types of AS/RS</li> <li>• Application of AS/RS</li> </ul> </li> </ul>	1		2	
4		3	Robots in Advanced Manufacturing <ul style="list-style-type: none"> <li>• Concepts of Industrial Robots</li> <li>• Impacts of Robots in Manufacturing</li> <li>• Application of Robots</li> </ul> Types of Robots <ul style="list-style-type: none"> <li>• Articulated Robots</li> <li>• SCARA Robots</li> <li>• Cartesian Robots</li> <li>• Delta Robots</li> </ul>	1		3	Demonstration - Future of Robots in Manufacturing <ul style="list-style-type: none"> <li>• Lights-Out Manufacturing</li> <li>• Internet of Things Capability</li> <li>• Transformations in Cybersecurity</li> <li>• Collaborative Industrial Robots- Cobots</li> </ul>	1		2	
4		4	Visit an Industry which is adopting Automation and Robotic control in Manufacturing						2		5
		5	CIE 5- Written and practice test				Assessment Review and corrective action			3	
		6	Industry Class on Robots in Manufacturing + Industry Assignment			5					

12	4	1	Tutorial (Peer discussion on Industrial assignment)	4	<b>Overview and Video Presentation on</b>	3		
					<ul style="list-style-type: none"> <li>Industry 4.0 Technologies</li> <li>Benefits of Industry 4.0 in Manufacturing</li> </ul>			
	4	2	<ul style="list-style-type: none"> <li>Convergence of IT (Information Technology) and OT (Operation Technology)</li> <li>Technologies which bring Convergence of OT and IT                             <ul style="list-style-type: none"> <li>➤ No code Application</li> <li>➤ Digital Twins</li> <li>➤ Augmented Reality</li> <li>➤ Edge computing</li> </ul> </li> </ul>	1	3	<ul style="list-style-type: none"> <li>Concepts of IIOT (Industry Internet of Things)- How it Works</li> <li>IIOT – Analytics and Data Management</li> </ul>	3	
	4	3	Demonstrate Adoption of IIOT Technology <ul style="list-style-type: none"> <li>Predictive maintenance.</li> <li>Remote Production Control.</li> <li>Asset tracking.</li> <li>Logistics management.</li> </ul>	1	3	Demonstrate IIOT for <ul style="list-style-type: none"> <li>Sustainability Assessment of Manufacturing Industry</li> <li>Lean Production System</li> <li>Smart Factories</li> </ul>	1	2
	4	4	Visit a Manufacturing Firm which is adopting IIOT				2	5
		5	Developmental Weekly Assessment			Assessment Review and corrective action		3
		6	Industry Class on Industry IIOT+ Industry Assignment			5		
13		<b>Internship</b> <ol style="list-style-type: none"> <li>Secondary research on various industries and their operations to identify at least 3 companies along with the areas of work interest and develop an internship plan that clearly highlights expectations from the industry during the internship.</li> <li>Design and develop a cover letter for an internship request to all 3 identified companies and the resume to be submitted to potential companies.</li> <li>Prepare for an internship interview to highlight your interests, areas of study, career aspirations</li> </ol>			<b>Project</b> <b>Internship/Project Total = 40Hrs</b> <ol style="list-style-type: none"> <li>Identification of the problem statement (from at least 3 known problems) the students would like to work as part of the project – either as provided by faculty or as identified by the student. Document the impact the project will have from a technical, social and business perspective.</li> <li>Design and develop the project solution or methodology to be used to</li> </ol>			40Hrs

			<p><b>and personnel competence - including the areas of learning you expect to learn during internship.</b></p>	<p><b>solve at least one of the problems identified.</b></p> <p><b>3 Prepare a project plan that will include a schedule, WBS Budget and known risks along with strategies to mitigate them to ensure the project achieves the desired outcome.</b></p>	
--	--	--	---	---	--

**Note:** Saturday session from 9 AM -2 PM

### References:

1. Andreas Gebhardt "Understanding Additive Manufacturing: Rapid Prototyping, Rapid Manufacturing" Hanser Gardner Publication
2. Kamrani A.K. and Nasr E.A., "Rapid Prototyping: Theory and practice", Springer
3. Liou L.W. and Liou F.W., "Rapid Prototyping and Engineering applications: A tool box for prototype development", CRC Press
4. Tom Page "Design for Additive Manufacturing" LAP Lambert Academic Publishing
5. Chua C.K., Leong K.F., and Lim C.S., "Rapid prototyping: Principles and applications", Third edition, World Scientific Publishers
6. Ian Gibson, David W. Rosen, Brent Stucker "Additive Manufacturing Technologies: Rapid Prototyping to Direct Digital Manufacturing" Springer
7. Rapid Prototyping: Laser-based and Other Technologies, Patri K. Venuvinod and Weiyin Ma, Springer, 2004.
8. Electron Beam welding, Schultz H., Woodhead Publishing, 1994
9. Principles of Plasma Discharge and Materials Processing, Lieberman M.A. and Lichtenberg A. J., Wiley Interscience, 1994.

10. Additive Manufacturing of Metals: The Technology, Materials, Design and Production, Li Yang · Keng Hsu · Brian Baughman Donald Godfrey · Francisco Medina Mamballykalathil Menon · Soeren Wiener, Springer, 2017.
11. Laser Additive Manufacturing of High-Performance Materials, Dongdong Gu, Springer, 2015
12. An Introduction to MEMS, Published in 2002 by PRIME Faraday Partnership
13. Unconventional Machining Process by Dr N Senthil Kumar, ARS Publications
14. Unconventional Machining Processes by Dr S Senthil, Suchithra Publications
15. Benedict. G.F. "Nontraditional Manufacturing Processes", Marcel Dekker Inc., New York, 1987.
16. Mc Geough, "Advanced Methods of Machining", Chapman and Hall, London, 1998.
17. Paul De Garmo, J.T.Black, and Ronald.A.Kohser, "Material and Processes in Manufacturing" Prentice Hall of India Pvt. Ltd., 8thEdition, New Delhi , 2001.
18. IIoT A Complete Guide - 2021 Edition by Gerardus Blokdyk
19. A Practical Guide for IoT Solution Architects By Dr Mehmet Yildiz
20. The Second Machine Age: Work, Progress and Prosperity in a Time of Brilliant Technologies by Erik Brynjolfsson and Andrew McAfee.

**CIE and SEE Assessment Methodologies**

<b>CIE Assessment</b>	<b>Assessment Mode</b>	<b>Duration In hours</b>	<b>Max Marks</b>
Week 3	CIE 1- Written and practice test	4	30
Week 5	CIE 2- Written and practice test	4	30
Week 7	CIE 3- Written and practice test	4	30
Week 9	CIE 4- Written and practice test	4	30
Week 11	CIE 5- Written and practice test	4	30
	On line Course work (Minimum 10 hours online course with certification from (SWAYAM/NPTEL/Infosys Springboard)		40
	Profile building for Internship / Submission of Synopsys for project work		20
Portfolio evaluation (Based on industrial assignments and weekly developmental assessment) *			30
<b>TOTAL CIE MARKS (A)</b>			<b>240</b>
<b>SEE 1 - Theory exam (QP from BTE) Conducted for 100 marks 3 hrs duration reduced to 60 marks</b>		<b>3</b>	<b>60</b>
<b>SEE 2 - Practical</b>		<b>3</b>	<b>100</b>
<b>TOTAL SEE MARKS (B)</b>			<b>160</b>
<b>TOTAL MARKS (A+B)</b>			<b>400</b>

\* The industrial assignment shall be based on peer-to-peer assessment for a total of 10 marks (on a scale of 1 to 10) and in the event of a group assignment the marks awarded will be the same for the entire group, the developmental assessment will be for a total of 20 marks and based on MCQ/case study/demonstration and such other assignment methods



**Assessment framework for CIE (1 to 5)****CIE 1- Model Question Paper****Note: Theory to be conducted for 1 hour and practice for 3 hours, total duration of exam – 4 hours**

<b>Programme</b>	<b>Mechanical Engineering</b>	<b>Semester</b>	<b>V</b>		
<b>Course</b>	<b>Advanced Manufacturing Technologies</b>	<b>Max Marks</b>	<b>30</b>		
<b>Course Code</b>	<b>20ME53I</b>	<b>Duration</b>	<b>4 hours</b>		
<b>Name of the course coordinator</b>					
Note: Answer one full question from each section.					
<b>Qn.No</b>	<b>Question</b>	<b>CL L3/L4</b>	<b>CO</b>	<b>PO</b>	<b>Marks</b>
<b>Section-1 (Theory) – 10 marks</b>					
1.a)	The materials used in the manufacturing of aircraft have changed significantly from the construction of the first aircraft. With its objective of flying using air support while, resisting gravitational forces, the materials used for the construction of aircraft must have some specific characteristics. Which are the advanced materials used in aircraft and what specific characteristics are present in these materials?	L3	01		05
b)	For the following application, identify one or more non-traditional machining processes that might be used, and present arguments to support your selection. Assume that either the part geometry or the work material (or both) prevents the use of conventional machining. <ul style="list-style-type: none"> <li>An engraved aluminium printing plate is to be used in an offset printing press to make 275 x 350 mm (11 x 14 in) posters of Independence Day. The engraving is as follows: " 75 Years of India's Independence"</li> </ul>	L4			05
2.a)	Superalloys are used in the most important temperature-limited applications. Specifically, they are usually used for turbine blades. Why are Superalloys important and also, Special?	L3			05

b)	A metal removal rate of 0.01 in <sup>3</sup> /min is achieved in a certain EDM operation on a pure iron work part. What metal removal rate would be achieved on nickel in this EDM operation if the same discharge current were used? The melting temperatures of iron and nickel are 2802°F and 2651°F, respectively.	L4			05
<b>Section-2 (Practical) - 20 marks</b>					
3)	Prepare a job using – EDM <ul style="list-style-type: none"> <li>• Study the component drawing</li> <li>• Select the process Parameter</li> <li>• Perform the process</li> <li>• Check for dimensional accuracies</li> </ul>	L4	01		20
4)	Prepare a job by Chemical Machining <ul style="list-style-type: none"> <li>• Study the component drawing</li> <li>• Select the process Parameter</li> <li>• Perform Clean, Mask, Scribe, Etch, Demask</li> <li>• Check for dimensional accuracies</li> </ul>	L4			20

**Note : Theory questions shall be aligned to practical questions**

#### Scheme of Evaluation for Practical question- Section 2

Sl. No	Description	Marks: 20
1	Analyze the given drawing and select the process parameter	07
2	Prepare the component by machining	07
3	Check for Dimensional accuracies	04
4	Suggest any innovating changes that can be incorporated	02
	<b>Total</b>	<b>20</b>

### Assessment framework for SEE 1 (Theory)

<b>Programme</b>	<b>Mechanical Engineering</b>	<b>Semester</b>	<b>: V</b>	
<b>Course</b>	<b>Advanced Manufacturing Technologies</b>	<b>Max Marks</b>	<b>: 100</b>	
<b>Course Code</b>	<b>20ME53I</b>	<b>Duration</b>	<b>: 3 Hrs</b>	
<b>Instruction to the Candidate:</b> Answer one full question from each section.				
Q.No	Question	CL (L3/L4)	CO	Marks
<b>Section-1</b>				
1.a)	Back in the days, aircraft were constructed using wood and fabrics. But aircraft that are made up of wood and fabric were subject to rapid deterioration and high maintenance. Thus, the search for better materials began. Now, aluminium, steel, titanium and composite materials are preferred in the construction of aerospace structures. Why such materials are used in Aerospace structures? Where else do you find the application of these materials?	L4	01	10
b)	For the following application, identify one or more non-traditional machining processes that might be used, and present arguments to support your selection. Assume that either the part geometry or the work material (or both) prevents the use of conventional machining. The application is a through-hole in the shape of the letter L in a 12.5 mm (0.5 in) thick plate of glass. The size of the “L” is 25 x15 mm (1.0x 0.6 in) and the width of the hole is 3 mm (1/8 in).	L4	01	10
2.a)	A furniture company that makes chairs and sofas must cut large quantities of fabrics. Many of these fabrics are strong and wear-resistant, which make them difficult to cut. What non-traditional process(es) would you recommend to the company for this application? Justify your answer by indicating the characteristics of the process that make it attractive.	L4	01	10

b)	An electric discharge machining operation is being performed on two work materials: tungsten and zinc. Determine the amount of metal removed in the operation after 1 hour at a discharge amperage = 20 amps for each of these metals. Express the answer in in <sup>3</sup> /hr. The melting temperatures of tungsten and zinc are 6170°F and 420°F, respectively.	L4		10
<b>Section-2</b>				
3.a)	Uniform Wares explores the advantages of additive manufacturing (AM) technology, pushing the boundaries of design in an industry traditionally centred around heritage. What benefits exist in additive manufacturing? Differentiate the technologies available in Additive manufacturing and list their applications?	L3	02	10
b)	In additive manufacturing, the material properties are being established alongside the geometry of the part. There are different classes of materials used in additive manufacturing. Differentiate these different materials used in Additive manufacturing with respect to their Properties and Applications?	L4		10
4.a)	The Airbus Helicopters cabin ventilation distributor was originally made by using composite of 7 separate parts. The objective was to minimize the final delivery time by dramatically reducing manufacturing time through 3D printing, using sintering technology, also ensuring lower manufacturing costs. Illustrate how this Process can be achieved?	L3		10
b)	Selective laser sintering (SLS) and 3D printing (3DP) are two powerful and versatile AM techniques which are applicable to powder-based material systems. Differentiate and suggest the best technique among the two. Present arguments to support your selection	L4		10
<b>Section- 3</b>				
5.a)	Additive Manufacturing (AM) components are known to have various internal defects, such as balling, porosity, internal cracks and thermal/internal stress, which can significantly affect the quality, mechanical properties and safety of final parts. Therefore, inspection methods are important for reducing manufactured defects and improving the surface quality and mechanical properties of AM components. Discuss different inspection methods adopted in AM with their merits and demerits?	L3	03	10
b)	AM-produced parts are being used by NASA in mission-critical situations and in the aviation and power industries where safety and reliability are of prime importance. These parts are tested using Non-Destructive testing methods. Suggest the best Non-Destructive testing method used in this case. Present arguments to support your selection	L4		10
6.a)	3D printing is finally crossing that threshold from prototype to production. However, there are still a few challenges that hold AM back such as quality measures and quality control. These	L3		10

	are essential for repeatability, consistency, scalability, and overall confidence in the process. Discuss different Quality control methods adopted in AM with their merits and demerits?			
b)	NDT methods are used for inspecting Manufactured parts. Why is Non-Destructive Testing (NDT) Important? What Tests are Available? What criteria are considered in selection of these NDT methods?	L4		10
<b>Section-4</b>				
7.a)	Automation in manufacturing is the process of using production management software or robotic tools to operate a factory when making a physical product. Discuss the various levels of Automation in Advanced Manufacturing.	L4	04	10
b)	Driverless vehicles and navigation systems are improving day after day and are contributing to boost the AGV (Automated guided Vehicle) Market worldwide. Illustrate the working principle of AGV.	L3		10
8.a)	Automated Storage and Retrieval Systems (ASRS or AS/RS) are used in applications where high volumes of inventory move in-and-out of manufacturing or distribution operations. Illustrate how an automated storage and retrieval systems work?	L3		10
b)	Modern organizations engage with two worlds. There is the traditional physical world composed of machines, electromechanical devices, and manufacturing systems. Then, there is the more recent digital world using servers, storage, networking and other devices used to run applications and process data. Does convergence of these two-world beneficial in Advanced manufacturing? Justify your argument with Illustration.	L4		10
<b>Section-5</b>				
9.a)	Laser Beam machining (LBM) is a well-established machining option for manufacturing geometrically complex or hard material parts that are extremely difficult-to-machine by conventional machining processes. Discuss the process parameters required in LBM process? Suggest a suitable process parameter that need to be considered for this case and justify.	L4	01	10
b)	Illustrate the Working of Electron Beam Machining process	L3		10
10.a)	Ultrasonic machining offers a solution to the expanding need for machining brittle materials such as single crystals, glasses and polycrystalline ceramics, and for increasing complex operations to provide intricate shapes and workpiece profiles. Illustrate the working of USM	L3		10
b)	Electrical discharge machining (EDM) is a well-established machining option for manufacturing geometrically complex or hard material parts that are extremely difficult-to-machine by conventional machining processes. Discuss the process parameters required in an EDM process? Suggest a suitable process parameter that need to be considered for this case and justify	L4		10



**Scheme of Evaluation for SEE 2**

Sl. No	Description	Marks
<b>Problem statement</b>	Prepare a job using – 3D Printing <ul style="list-style-type: none"> <li>• Study the component drawing</li> <li>• Select the process Parameter</li> <li>• Perform the process</li> <li>• Check for dimensional accuracies</li> </ul>	<b>100</b>
1	Prepare a Solid model and convert to STL File	30
2	Select a suitable material for the given model, Perform Machine setting and upload the STL file	20
3	Feed the Raw material and Develop the Model	40
4	Perform measurement with desired accuracy to check the components for Functionality and conformance to defined standards using different instruments.	10
<b>Total</b>		<b>100</b>

# E-Mobility





**Government of Karnataka**  
**DEPARTMENT OF COLLEGIATE and TECHNICAL EDUCATION**

<b>Program</b>	<b>Mechanical Engineering</b>	<b>Semester</b>	<b>5</b>
<b>Course Code</b>	<b>20ME54I</b>	<b>Type of Course</b>	<b>L: T:P (104:52:312)</b>
<b>Specialization</b>	<b>E-Mobility</b>	<b>Credits</b>	<b>24</b>
<b>CIE Marks</b>	<b>240</b>	<b>SEE Marks</b>	<b>160</b>

## **Introduction:**

Welcome to the curriculum for the Specialization Pathway - **E-Mobility**. This specialization course is taught in Bootcamp mode. Bootcamps are 12 weeks, intense learning sessions designed to prepare you for the practical world – ready for either industry or becoming an entrepreneur. You will be assisted through the course, with development-based assessments to enable progressive learning.

The automotive industry is already expanding and growing faster than before. With these advancements in place, it is evident that EV is creating ripples, redefining transportation in a new way. While these developments are fascinating, the evolving nature of the sector makes it complex with each passing day, and hence, a complete understanding of the system and in-depth exposure is necessary.

Leading to the successful completion of this bootcamp, you shall be equipped to either do an internship in an organisation working on E Mobility or do a capstone project in the related field. After the completion of your Diploma, you shall be ready to take up roles like a design or maintenance assistant and can rise up to the level of a design or maintenance engineer, also can become Entrepreneur in the related field and more

This course will teach you to manage electric vehicle complexity, optimize vehicle performance, and more by using Model-based Systems and better understand the intricate EV architecture.

Details of the curriculum is presented in the sections below.

## **Pre-requisite**

Before the start of this specialization course, you will have prerequisite knowledge gained in the first two years on the following subjects:

1<sup>st</sup> year -Engineering Mathematics, Communication Skills, Computer Aided Engineering Graphics, Statistics & Analysis, Basic IT Skills, Fundamentals of Electrical and Electronics Engineering, Project Management skills Engineering Materials and Mechanical Workshop

2<sup>nd</sup> year-Mechanics of Materials, Machine Tool Technology, Manufacturing Process, Fluid Power Engineering, Product Design and Development, Operations Management, CNC Machines and Elements of Industrial Automation, in this year of study, you shall be applying your previous years learning along with specialized field of study into projects and real-world applications.

## Instruction to course coordinator

1. Each Pathway is restricted to a Cohort of 20 students which could include students from other relevant programs.
2. Single faculty shall be the Cohort Owner.
3. This course shall be delivered in boot camp mode
4. The industry session shall be addressed by (in contact mode/online / recorded video mode) industry experts only.
5. The cohort owner shall identify experts from the relevant field and organize industry session as per schedule.
6. Cohort owner shall plan and accompany the cohort for industrial visits.
7. Cohort owner shall maintain and document the industrial assignments and weekly assessments, practices and mini project.
8. The cohort owner shall coordinate with faculties across programs needed for their course to ensure seamless delivery as per time table
9. The cohort owner along with classroom, can augment or use for supplementally teaching, on line courses available although reliable and good quality online platforms like Karnataka LMS, Infosys Springboard, NPTEL, Unacademic, SWAYAM, etc.
10. Cohort owner shall guide the cohort for the execution of mini project

## Course Outcomes

After completing the course, the students will be able to:

<b>CO-01</b>	Demonstrate the components, architecture and technologies in electric vehicles
<b>CO-02</b>	Analyze the vehicle dynamics, Transmission system, suspension systems; braking system and steering systems in electric vehicles
<b>CO-03</b>	Analyze the use of different power electronics converters and electrical machines in electric vehicles.
<b>CO-04</b>	Analyze the use of different energy storage systems, charging system, their control techniques, and energy management technology for electric vehicles
<b>CO-05</b>	Demonstrate the electrical systems, communication protocols and Maintenance in Electric vehicles
<b>CO-06</b>	Model the Electric vehicle and analyze its performance using a simulation software

## Detailed course plan

Week	C O	P O	Days	1 <sup>st</sup> session (9am to 1 pm)	L	T	P	2 <sup>ND</sup> session (1.30pm to 4.30pm)	L	T	P
1	1		1	<b>Introduction</b> <ul style="list-style-type: none"> <li>• Principles and Trends of e-Mobility</li> <li>• e-Mobility Business Model</li> <li>• Impact of mobility on existing sectors</li> <li>• e-mobility for personal vehicles</li> <li>• e-mobility in public transportation</li> <li>• e- mobility in goods transport</li> <li>• Environmental impact of e-Mobility</li> </ul>	4			<ul style="list-style-type: none"> <li>• Overview on Conventional Vehicles- Components, Working Principle</li> <li>• Overview of EV such as Tesla, Hyundai, TATA, KIA, MG, Mahindra motors etc</li> <li>• Technology and Market Scenario in Indian and global perspective</li> <li>• Merits and demerits of Electric vehicles</li> </ul>	3		
	2		2	<b>Vehicle Dynamics</b> <ul style="list-style-type: none"> <li>• Fundamentals of Vehicle Dynamics</li> <li>• Vehicle resistance, Types: Rolling Resistance, gradient resistance, Aerodynamic drag</li> <li>• Tire- Ground Adhesion</li> </ul>	4			<ul style="list-style-type: none"> <li>• Calculating the Rolling Resistance</li> <li>• Calculating the gradient resistance</li> <li>• Calculate the Aerodynamic drag</li> <li>• Calculating the Acceleration Force</li> <li>• Calculate the maximum speed of the vehicle</li> <li>• Calculate the Maximum Tractive Effort and Powertrain Tractive Effort</li> <li>• Find the Total Tractive Force</li> <li>• Calculate the Torque Required on the Drive Wheel</li> </ul>	1		<b>2</b>
	2		3	<ul style="list-style-type: none"> <li>• Calculating the Rolling Resistance</li> <li>• Calculating the gradient resistance</li> <li>• Calculate the Aerodynamic drag</li> <li>• Calculating the Acceleration Force</li> <li>• Calculate the maximum speed of the vehicle</li> <li>• Calculate the Maximum Tractive Effort and Powertrain Tractive Effort</li> <li>• Calculate the Torque Required on the Drive Wheel</li> </ul>							7

	2		4	<b>Suspension system</b> <ul style="list-style-type: none"> <li>• Explain and demonstrate the working principle and components of Double Wishbone suspension</li> <li>• Explain and demonstrate the working principle and components of Trailing twist axle suspension</li> <li>• Explain and demonstrate the working principle and components of Macpherson Srut suspension</li> <li>• Explain and demonstrate the working principle and components of electronic adjustable-rate shock absorbers</li> </ul>	2		2	<b>Transmission system</b> Explain and Demonstrate the Working principle and components of Power transmission system used in EV  <b>Chassis System</b> <ul style="list-style-type: none"> <li>• Explain and demonstrate the different Chassis systems in EV</li> </ul>	1		2
			5	Weekly developmental Assessment				Assessment Review and corrective action			3
			6	Industry Class on vehicle dynamics + Industry Assignment			5				
2	2		1	Tutorial (Peer discussion on Industrial assignment)		4		<b>Tires and Wheels</b> <ul style="list-style-type: none"> <li>• Designation of tires</li> <li>• Explain JATMA, ETRTO standards,</li> <li>• Tire selection considerations for EV</li> <li>• Compare Diagonal vs Radial tires</li> <li>• Compare Tubed vs Tubeless tires</li> </ul>	3		
	2		2	<b>Steering Systems</b> <ul style="list-style-type: none"> <li>• Explain the importance of steering geometry (Caster, Camber, Kingpin inclination, Toe-in, Toe-out)</li> <li>• Explain and demonstrate the working principle and</li> </ul>	2		2	<b>Braking System</b> <ul style="list-style-type: none"> <li>• Explain and demonstrate the working principle and components of disc and drum brakes.</li> <li>• Explain and demonstrate the working principle and components of hydraulic brakes</li> </ul>	2		1

				components of electronic power assisted steering				<ul style="list-style-type: none"> <li>Calculate Braking Performance and Distribution braking Force</li> </ul>			
2		3	<ul style="list-style-type: none"> <li>Explain and demonstrate the working principle and components of Electric brakes</li> <li>Explain and demonstrate the working principle and components of Electro hydraulic braking (EHB)</li> <li>Explain and demonstrate the working principle and components of Electronic Parking Brake (EPB)</li> </ul>	2		2	<ul style="list-style-type: none"> <li>Explain and demonstrate the working principle and components ABS brake system</li> <li>Explain and Demonstrate Wheel speed sensors, ABS with Electronic Brake force Distribution (EBD) control unit</li> <li>Explain and Demonstrate Electronic Stability Control (ESC)</li> <li>Explain and Demonstration on warning &amp; safety device</li> </ul>	2		1	
1		4	<b>Architecture of EV</b> <ul style="list-style-type: none"> <li>Explain and Demonstrate the Architecture, working principle, Major component, performance parameter, merits and demerits of all Electric Battery Electric Vehicles (BEV)</li> </ul>	2		2	<ul style="list-style-type: none"> <li>Explain and Demonstrate the Architecture, working principle, Major component, performance parameter, merits and demerits of Hybrid-Electric Vehicles (HEV)</li> </ul>	2		1	
		5	Weekly developmental Assessment				Assessment Review and corrective action			3	
		6	Industry Class on Steering geometry, transmission system and ABS + Industry Assignment			5					

Week	C O	P O	Days	1 <sup>st</sup> session (9am to 1 pm)	L	T	P	2 <sup>ND</sup> session (1.30pm to 4.30pm)	L	T	P
3	1		1	Tutorial (Peer discussion on Industrial assignment)		4		<ul style="list-style-type: none"> <li>Explain and Demonstrate the Architecture, working principle, Major component, performance parameter, merits and demerits of Plug-in hybrid vehicles (PHEV)</li> </ul>	1		2

	1		2	<ul style="list-style-type: none"> <li>Explain and Demonstrate the Architecture, working principle, Major component, performance parameter, merits and demerits of Fuel cell electric vehicles (FCEV)</li> </ul>	2		2	<ul style="list-style-type: none"> <li>Compare the features of BEV, HEV, PHEV, FCEV type of vehicles</li> <li>Discuss on current adoption status of BEV, HEV, PHEV, FCEV type vehicles</li> </ul>	3		
	3		3	<b>Electric Machines and Drives</b> <ul style="list-style-type: none"> <li>Explain and demonstrate the working principles and components of DC Motor and Brushless DC motors (BLDC)</li> </ul>	2		2	<ul style="list-style-type: none"> <li>Explain and demonstrate the working principles and components of Induction motors</li> </ul>	1		2
	3		4	<ul style="list-style-type: none"> <li>Explain and demonstrate the Working principle and components of Permanent magnet synchronous motor (PMSM)</li> </ul>	2		2	<ul style="list-style-type: none"> <li>Explain and demonstrate the Working principle and components of Switched Reluctance Motor (SRM)</li> </ul>	1		2
			5	CIE 1- Written and practice test				Assessment Review and corrective action			3
			6	Industry Class on architecture of EV + Industry Assignment			5				
4	3		1	Tutorial (Peer discussion on Industrial assignment)		4		<ul style="list-style-type: none"> <li>Calculate speed and Torque of motor</li> <li>Calculate Power consumption of EV</li> <li>Selection and sizing of Motor</li> </ul>			4
	3		2	<ul style="list-style-type: none"> <li>Calculate speed and Torque of motor</li> <li>Calculate Power consumption of EV</li> <li>Selection and sizing of Motor</li> </ul>							7
	3		3	<ul style="list-style-type: none"> <li>Discuss the merits and demerits of DC motors, BLDC motors, Induction motors, PMSM motors and SRM motors</li> <li>Discuss the type of Electric drives used in EV such as Tesla, Hyundai, TATA, KIA, MG, Mahindra motors</li> </ul>	4			<ul style="list-style-type: none"> <li>Explain the Principle of Regenerative Braking</li> <li>Explain the Regenerative Brake cooperative control operation. Riding Modes -Sport and Comfort, Driver Behaviour, Economy mode</li> </ul>	3		

				etc with their specifications from company catalogue							
	3		4	<b>Control Unit and Control Strategies</b> <ul style="list-style-type: none"> <li>• Explain and Demonstrate DC-DC Converters</li> <li>• Explain and Demonstrate DC-AC Converters</li> <li>• Explain and Demonstrate AC-DC Converters</li> <li>• Explain Switch Controller</li> <li>• Explain Solid-State Controller</li> <li>• Explain Electronic Controllers</li> </ul>	4			<ul style="list-style-type: none"> <li>• Explain and Demonstrate AC Controllers</li> <li>• Explain and Demonstrate DC Motor Controller- The Lesson of the Jones Switch</li> <li>• Explain Off-the-Shelf Curtis PWM DC Motor Controller</li> </ul>			<b>3</b>
			5	Weekly developmental Assessment				Assessment Review and corrective action			<b>3</b>
			6	Industry Class on electric drives and their control strategies + Industry Assignment			5				<b>3</b>
<b>5</b>	3		1	Tutorial (Peer discussion on Industrial assignment)		4		<ul style="list-style-type: none"> <li>• Explain Zilla Controller</li> <li>• Explain ZAPI Control Strategies</li> <li>• Explain Max. SOC-of-PPS Control Strategy (SOC- State of Charge; PPS- Peak power source)</li> </ul>	3		
	3,6		2	Modelling of Electric machines and controllers by using simulation software							<b>7</b>
	3,6		3	Modelling of Electric machines and controllers by using simulation software							<b>7</b>
	3,6		4	Modelling of Electric machines and controllers by using simulation software							<b>7</b>
			5	CIE 2- Written and practice test				Assessment Review and corrective action			<b>3</b>
			6	Industry Class on modelling of electric drives and controllers + Industry Assignment			<b>5</b>				
<b>6</b>	4		1	Tutorial (Peer discussion on Industrial assignment)		4		<b>Energy Storage Solutions (ESS)</b> <ul style="list-style-type: none"> <li>• Explain Battery capacity, Discharge Rate, State of Charge (SOC), State of Health (SOH), State of Energy (SoE) State of Power (SOP), state of discharge (SOD) Depth of discharge (DOD), C -Rate</li> </ul>	2		<b>1</b>

							<ul style="list-style-type: none"> <li>• Explain Thermodynamic Voltage, Specific Energy, Specific Power, Energy Efficiency</li> </ul>			
4		2	Classification of Batteries <ul style="list-style-type: none"> <li>➤ Primary</li> <li>➤ Secondary                             <ul style="list-style-type: none"> <li>• Li-ion</li> <li>• Na-ion</li> <li>• Mg-ion</li> <li>• K-ion</li> </ul> </li> </ul> Geometry of Batteries <ul style="list-style-type: none"> <li>➤ Coin Cell</li> <li>➤ Cylindrical Cell</li> <li>➤ Stack Cell</li> <li>➤ Pouch Cell</li> </ul> Chemistry behind Batteries Battery Materials- Anode, Cathode, Electrolyte, Separator Explain the working principle, of Lead Acid and Lithium-ion (Li-ion) batteries used in electric vehicle	4			<ul style="list-style-type: none"> <li>• Future developments in Batteries- Na-ion, Mg-ion K-ion, Li air</li> <li>• Discuss Corrosion of Battery Terminals</li> <li>• Discuss Lithium-Ion Batteries Aging Effects</li> <li>• Discuss on Selection and sizing of cells and Handling of Cells</li> <li>• Explain working principle of Ultra capacitors and its features</li> </ul>	3		
4		3	<ul style="list-style-type: none"> <li>• Explain Cell Charging and Discharging cycles and Discharging Curves</li> <li>• Ragone plot for Batteries</li> <li>• Calculations on Battery charging and discharging</li> <li>• Explain the Temperature impact on cell, Internal resistance</li> <li>• Study the Lifecycle of batteries</li> <li>• Discuss Battery Fabrication Process</li> </ul>	4			<b>Battery Module and Pack Development</b> <ul style="list-style-type: none"> <li>• Demonstrate the Battery Pack Module Construction, Configurations, Types and Energy Concepts</li> <li>• Demonstrate the Voltage, Current and Temperature Measurement</li> <li>• Discuss the Battery pack selection criteria</li> </ul>	1		2
4		4	<b>Battery Management System (BMS)</b> <ul style="list-style-type: none"> <li>• Discuss the Need of BMS</li> </ul>	4			<b>EV Thermal Management</b> <ul style="list-style-type: none"> <li>• Explain Cooling of Battery Pack, Motor and Inverter</li> </ul>	3		



				<ul style="list-style-type: none"> <li>• Explain L9963 battery management device</li> <li>• Explain the Voltage, Current and Temperature Monitoring,</li> <li>• Demonstrate various sensors installed on BMS</li> <li>• Explain Battery management design considerations (Service life, efficiency, safety, operational parameters)</li> <li>• Discuss Cell Balancing - Types, Active, Passive, SoC Determination, SoC Algorithms</li> </ul>				<ul style="list-style-type: none"> <li>• Explain Active and Passive Cooling</li> <li>• Explain Fluid Based Cooling, Ethylene Glycol,</li> <li>• Explain Forced Air Cooling, Cabin Air Based Cooling</li> </ul>			
			5	Weekly developmental Assessment				Assessment Review and corrective action			3
			6	Industry Class on Battery technology and BMS + Industry Assignment			5				
<b>Week</b>	<b>C O</b>	<b>P O</b>	<b>Days</b>	<b>1<sup>st</sup> session (9am to 1 pm)</b>	<b>L</b>	<b>T</b>	<b>P</b>	<b>2<sup>ND</sup> session (1.30pm to 4.30pm)</b>	<b>L</b>	<b>T</b>	<b>P</b>
7	4,6		1	Tutorial (Peer discussion on Industrial assignment)		4		<ul style="list-style-type: none"> <li>• Modeling of Electric vehicle batteries and battery pack by using simulation software</li> </ul>			3
	4,6		2	<ul style="list-style-type: none"> <li>• Modeling of Electric vehicle batteries and battery pack by using simulation software</li> </ul>							7
	4,6		3	<ul style="list-style-type: none"> <li>• Modeling of Electric vehicle batteries and battery pack by using simulation software</li> </ul>							7
	4,6		4	<ul style="list-style-type: none"> <li>• Modeling of Electric vehicle batteries and battery pack by using simulation software</li> </ul>							7
			5	CIE 3- Written and practice test				Assessment Review and corrective action			3
			6	Industry Class on modeling of EV batteries + Industry Assignment			5				

8	4		1	Tutorial (Peer discussion on Industrial assignment)		4	<b>Electric Vehicles charging station</b> <ul style="list-style-type: none"> <li>• Explain and Demonstrate the Electric Vehicle charging Technology and Charging Equipment's</li> <li>• Draw Basic charging Block Diagram of Charger</li> <li>• Differentiate Slow charger, fast charger and Rapid charger</li> <li>• Explain Slow charger design rating</li> <li>• Explain Fast charger design rating</li> </ul>	2		1
	4		2	<ul style="list-style-type: none"> <li>• Demonstrate AC charging and DC charging methods</li> <li>• Demonstrate Inboard and off board charging methods and specification</li> <li>• Demonstrate Modes of charger- Mode -2, Mode-3 and Mode-4</li> <li>• Perform EVSE (Electric Vehicle supply Equipment) associated charge time Calculation.</li> </ul>		4	<b>Selection and sizing of fast and slow Charger</b> <ul style="list-style-type: none"> <li>• Demonstrate AC Pile Charger</li> <li>• Demonstrate DC Pile Charger</li> <li>• Demonstrate EVSE Power Module selection and technical specification</li> </ul>			3
	4		3	<ul style="list-style-type: none"> <li>• Demonstrate Specification of open charge point protocol (OCCP 1.6/2.0)</li> <li>• Demonstrate Bharat DC001 &amp; AC001 Charger specification</li> <li>• Demonstrate Communication Interface between charger and CMS (central management system)</li> </ul>		4	<b>Selection and sizing of Common types of connectors and applications</b> <ul style="list-style-type: none"> <li>• Demonstrate Selection of AC charger type-1, type -2 and type -3</li> <li>• Demonstrate Communication between charging station and EV</li> </ul>			3
	4		4	<ul style="list-style-type: none"> <li>• Demonstrate Selection of DC charger connector GB/T, CHAdeMO, CCS-1 and CSS-2</li> <li>• Demonstrate Communication methodology of DC fast chargers</li> </ul>		4	<ul style="list-style-type: none"> <li>• Demonstrate IS/ IEC/ARAI/ standard of Charging topology, Communication and connectors (IEC 61851-1, IEC 61851-24,62196-2)</li> </ul>			3

				<ul style="list-style-type: none"> <li>Sizing of Charger connector cable</li> </ul>						
		5	Weekly developmental Assessment				Assessment Review and corrective action			3
		6	Industry Class on EV chargers and charging stations + Industry Assignment			5				
9	5	1	Tutorial (Peer discussion on Industrial assignment)				<b>Trace and Test all Electrical &amp; Electronic components &amp; circuits</b> <ul style="list-style-type: none"> <li>Demonstrate the EV electrical architecture, power supply systems by using service manual</li> </ul>			3
	5	2	<ul style="list-style-type: none"> <li>Identify the electrical and electronics components in a vehicle</li> <li>Explain and Demonstrate the Wiring Harness Design, Harness Topology.</li> </ul>	2		2	<ul style="list-style-type: none"> <li>Hands on removing and fitting basic electrical and electronic components</li> </ul>			3
	5	3	<b>Trace the wiring circuit of lighting system in an EV</b> <ul style="list-style-type: none"> <li>Explain and Demonstrate Headlight &amp; dimmer circuits, Park &amp; taillight circuits, Brake light circuits, turn signal circuit, Cornering lights, Fog lights circuit, interior lights courtesy, reading and instrument panel lights, Smart lighting, Reverse lights circuits</li> </ul>	2		2	<b>HVAC</b> <ul style="list-style-type: none"> <li>Explain and demonstrate the working principle and components of HVAC in EV</li> <li>Climate Control System in EV</li> </ul>			3
	5	4	<b>Vehicle and Occupants Safety</b> <ul style="list-style-type: none"> <li>Explain and demonstrate the types of safety systems and their functions and applications. - Seat Belt, Child Restraint System (CRS), Air Bag - Supplemental Restraint System (SRS), Cruise Control, Central Lock System</li> </ul>			4	<b>Instrument Cluster</b> <ul style="list-style-type: none"> <li>Explain and demonstrate the electronic instrumentation cluster for battery status, distance to empty, battery temperature, gear position indicator, tire air pressures, cabin temperature, vehicle speed, trip information,</li> </ul>			3

			(CTL), Parking electronic System (PTS), power windows, Smart key				Warning and indicator lights, display messages, GPS, fault diagnosis etc			
		5	CIE 4- Written and practice test				Assessment Review and corrective action			3
		6	Industry Class on electronic vehicle management system + Industry Assignment			5				
10	5	1	Tutorial (Peer discussion on Industrial assignment)				<b>Communication protocols</b> <ul style="list-style-type: none"> <li>Explain and Demonstrate the Application of Automotive bus system-CAN (Control Area Network)</li> </ul>	3		
	5	2	<ul style="list-style-type: none"> <li>Explain and Demonstrate the Application of Automotive bus system- LIN (Local Interconnect Network)</li> </ul>	4			<ul style="list-style-type: none"> <li>Explain and Demonstrate the Application of Automotive bus system- FlexRay™ and MOST (Media Oriented Systems Transport).</li> </ul>	3		
	5	3	<b>Vehicle Telematics</b> <ul style="list-style-type: none"> <li>Explain Integrated communications, Global positioning satellites, Triangulation/ trilateration, Telematics</li> </ul>	4			<ul style="list-style-type: none"> <li>Explain Integrated communications, Global positioning satellites, Triangulation/ trilateration, Telematics</li> </ul>	3		
	5	4	<b>Advancement in EV technology</b> <ul style="list-style-type: none"> <li>Explain the Advanced Driver Assist vehicle system architecture (ADAS)</li> <li>Explain the ADAS system components- LIDAR, AI cameras, collision detection, object detection, Adaptive Cruise Control,</li> </ul>	4			<ul style="list-style-type: none"> <li>Intelligent Speed Adaptation, Driver Monitoring System, Drowsy Driver Warning, Driver Fatigue Warning, Blind Spot Detection, Lane Keeping Assist, Lane Departure Warning, etc</li> </ul>	3		

			5	Weekly developmental Assessment				Assessment Review and corrective action			3
			6	Industry Class on EV communication protocol + Industry Assignment			5				
Week	C O	P O	Days	1 <sup>st</sup> session (9am to 1 pm)	L	T	P	2 <sup>ND</sup> session (1.30pm to 4.30pm)	L	T	P
11	6		1	Tutorial (Peer discussion on Industrial assignment)		4		Model the Electric vehicle by using simulation software and analyze the EV performance parameters such as speed, Torque, Top speed reached, distance travelled, SOC, regenerative braking effort, current, voltage for different drive cycles, electric drives & power rating, and also analyze the impact of vehicle dynamics like rolling resistance, air drag, frontal area, weight of the body etc on EV performance			3
	6		2	Model the Electric vehicle by using simulation software and analyze the EV performance parameters such as speed, Torque, Top speed reached, distance traveled, SOC, regenerative braking effort, current, voltage for different drive cycles, electric drives & power rating, and also analyze the impact of vehicle dynamics like rolling resistance, air drag, frontal area, weight of the body etc on EV performance							7
	6		3	Model the Electric vehicle by using simulation software and analyze the EV performance parameters such as speed, Torque, Top speed reached, distance traveled, SOC, regenerative braking effort, current, voltage for different drive cycles, electric drives & power rating, and also analyze the impact of vehicle dynamics like rolling resistance, air drag, frontal area, weight of the body etc on EV performance							7
	6		4	Model the Electric vehicle by using simulation software and analyze the EV performance parameters such as speed, Torque, Top speed reached, distance travelled, SOC, regenerative braking effort, current, voltage for different drive cycles, electric drives & power rating, and also analyze the impact of vehicle dynamics like rolling resistance, air drag, frontal area, weight of the body etc on EV performance							7
			5	CIE 5- Written and practice test				Assessment Review and corrective action			3
			6	Industry Class on modeling of EV + Industry Assignment			5				
12	5		1	Tutorial (Peer discussion on Industrial assignment)				Precaution to be taken care while handling the electric vehicle. <ul style="list-style-type: none"> <li>Things to know while handling EVs</li> </ul>	2		1

							<ul style="list-style-type: none"> <li>Importance of Practicing Battery Safety for Electric Vehicles</li> </ul>			
5		2	Safety of e- vehicle batteries- <ul style="list-style-type: none"> <li>Electric system safety - Protection against electric shocks, Protection against direct contact, Protection against indirect contact</li> <li>Functional system safety - System activation warning, Power on procedure, driving backwards: Prevention of fierce reverse braking, Emergency disconnect device, Fail-safe operation- Power surge prevention, Fail-safe operation - Frame faults, Fail-safe operation - Electromagnetic compatibility, The auxiliary network,</li> <li>Battery charging safety- electrical aspect, mechanical aspect, chemical aspect, explosion hazard</li> </ul>	2		2	Maintenance in EV <ul style="list-style-type: none"> <li>First-line maintenance: by the user</li> <li>Second-line maintenance: in the Authorised service centre.</li> <li>Maintenance for safe operation</li> </ul>	1		2
5		3	Visit an EV authorized service station and observe the following <ul style="list-style-type: none"> <li>Observe the Safety Precaution practices followed while handling EV's</li> <li>Study the job card and case history of the vehicles</li> <li>Study the owner's instruction manual for periodic maintenance</li> <li>Interact with the Service execute while Vehicle Inspection form is recorded</li> <li>Observe the use of Diagnostics software</li> <li>Observe the Periodic maintenance and repair performed on EV's</li> </ul>							7
5		4	Visit an EV authorized service station and observe the following <ul style="list-style-type: none"> <li>Observe the Safety Precaution practices followed while handling EV's</li> <li>Study the job card and case history of the vehicles</li> <li>Study the owner's instruction manual for periodic maintenance</li> <li>Interact with the Service execute while Vehicle Inspection form is recorded</li> </ul>							7

				<ul style="list-style-type: none"> <li>Observe the use of Diagnostics software</li> <li>Observe the Periodic maintenance and repair performed on EV's</li> </ul>					
		5	Weekly developmental Assessment				Assessment Review and corrective action		3
		6	Industry Class on modeling of EV + Industry Assignment			5			
<b>13</b>		1	<b>Internship</b> a) Secondary research on various industries and their operations to identify at least 3 companies along with the areas of work interest and develop an internship plan that clearly highlights expectations from the industry during the internship. b) Design and develop a cover letter for an internship request to all 3 identified companies and the resume to be submitted to potential companies. c) Prepare for an internship interview to highlight your interests, areas of study, career aspirations and personnel competence – including the areas of learning you expect to learn during internship.	<b>Project</b> a) Identification of the problem statement (from at least 3 known problems) the students would like to work as part of the project – either as provided by faculty or as identified by the student. Document the impact the project will have from a technical, social and business perspective. b) Design and develop the project solution or methodology to be used to solve at least one of the problems identified. c) Prepare a project plan that will include a schedule, WBS, Budget and known risks along with strategies to mitigate them to ensure the project achieves the desired outcome.		<b>Internship/Project</b> Total = 40Hrs			

**References:**

1. Iqbal Husain, Electric and Hybrid Vehicles –Design Fundamentals, CRC Press
2. Mehrdad Ehsani, Yimin Gao, Sebastian E.Gsay, Ali Emadi, Modern Electric, Hybrid Electric and Fuel Celll vehicles-Fundamentals - Theory and Design”, CRC Press
3. Energy Storage by Robert A. Huggins, Springer Publication
4. Handbook of Energy Audit, Albert Thumann P.E. CEM, William J. Younger CEM, The Fairmont Press Inc., 7th Edition.
5. Energy storage (A new approach) by Ralph Zito Wiley Publication
6. Energy Management Handbook, Wayne C. Turner, The Fairmont Press Inc., 5th Edition,Georgia
7. Energy Storage Systems, Alfred Rufer, CRC Press
8. Chang Liang Xia, ”Permanent Magnet Brushless Dc Motor Drives and Controls” Wiley 2012.
9. Bimal K Bose, " Modern Power Electronics and AC Drives", Pearson Education, Second Edition, 2003
10. Miller. T. J. E., "Brushless Permanent Magnet and Reluctance Motor Drives", Clarendon Press, Oxford, 1989
11. Kenjo. T and Nagamori. S, "Permanent Magnet and Brushless DC Motors", Clarendon Press, Oxford, 1989.
12. Robert .L.Boylsted,and Louis Nashelsky, "Electronic Devices and Circuit Theory”, Pearson Education,9th edition,2009
13. David A Bell, "Fundamentals of Electronic Devices and Circuits”, Oxford University Press, 2009.
14. Albert D Halfride & William D Cooper, “Modern Electronic instrumentation and Measurement techniques”, Prentice Hall of India Pvt Ltd., 2007.
15. Rajendra Prasad, “Electrical Measurements & Measuring instruments”, C Publishers, 4th Edition, 2004



**CIE and SEE Assessment Methodologies**

<b>CIE Assessment</b>	<b>Assessment Mode</b>	<b>Duration In hours</b>	<b>Max Marks</b>
Week 3	CIE 1- Written and practice test	4	30
Week 5	CIE 2- Written and practice test	4	30
Week 7	CIE 3- Written and practice test	4	30
Week 9	CIE 4- Written and practice test	4	30
Week 11	CIE 5- Written and practice test	4	30
	On line Course work (Minimum 10 hours online course with certification from (SWAYAM/NPTEL/Infosys Springboard)		40
	Submission of Profile building for Internship / Synopsys for project work		20
Portfolio evaluation (Based on industrial assignments and weekly developmental assessment) *			30
<b>TOTAL CIE MARKS (A)</b>			<b>240</b>
<b>SEE 1 - Theory exam (QP from BTE) Conducted for 100 marks 3 hrs duration reduced to 60 marks</b>		<b>3</b>	<b>60</b>
<b>SEE 2 - Practical</b>		<b>3</b>	<b>100</b>
<b>TOTAL SEE MARKS (B)</b>			<b>160</b>
<b>TOTAL MARKS (A+B)</b>			<b>400</b>

\* The industrial assignment shall be based on peer-to-peer assessment for a total of 10 marks (on a scale of 1 to 10) and in the event of a group assignment the marks awarded will be the same for the entire group, the developmental assessment will be for a total of 20 marks and based on MCQ/case study/demonstration and such other assignment methods

**Assessment framework for CIE (1 to 5)**  
**CIE 1 - Model question paper**

**Note: Theory to be conducted for 1 hour and practice for 3 hours, total duration of exam - 4 hours**

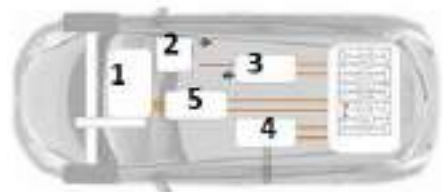
<b>Programme</b>	<b>Mechanical Engineering</b>	<b>Semester</b>	<b>V</b>		
<b>Course</b>	<b>E- Mobility</b>	<b>Max Marks</b>	<b>30</b>		
<b>Course Code</b>	<b>20ME54I</b>	<b>Duration</b>	<b>4 hours</b>		
<b>Name of the course coordinator</b>					
Note: Answer one full question from each section.					
<b>Qn.No</b>	<b>Question</b>	<b>CL L3/L4</b>	<b>CO</b>	<b>PO</b>	<b>Marks</b>
<b>Section-1 (Theory) - 10 marks</b>					
1.a)	<p>The Architecture of an Electric Vehicle is as shown in the Diagram. Identify the different components?</p> 	L3	01		02
b)	<p>Electric vehicle is now becoming a need of the current era, to meet the environmental target of zero emission. EV's must be sustainable for society and that will be achieved by the Electric vehicle architecture. Vehicle architecture needs to be flexible so that they can adopt drivetrain electrification. Illustrate how the Architecture of battery electric vehicle is different from Conventional Vehicle?</p>	L4	01		08
2.a)	<p>Identify the types of Electric Vehicles shown in (a), (b), (c), (d).</p>	L3	01		03

b)	<p>Development and evolution of the electric vehicles have undergone a great growth, especially in the last 5 years. Technological developments are providing enhanced solutions for EV. What are the technological developments that have surfaced in EV's? Discuss with Illustration</p>	L4	01		07
<b>Section-2 (Practice) - 20 marks</b>					
3)	Demonstrate the Working principle and components of BLDC motor used in EV	L4	03		20
4)	Demonstrate the working principles and components of Induction motor used in EV	L4	03		20

**Note : Theory questions shall be aligned to practical questions**

**Scheme of Evaluation for Practical question- Section 2**

Sl. No	Description	Marks: 20
1	Identify the components of BLDC motor/Induction motor	05
2	Functions of each component	05
3	Working of the BLDC motor /Induction Motor	07
4	Suggest any innovating changes that can be incorporated	03

	<b>Total</b>	<b>20</b>
--	--------------	-----------

**Assessment framework for SEE 1 (Theory)**

<b>Programme</b> : Mechanical Engineering	<b>Semester</b> : V
<b>Course</b> : E- Mobility	<b>Max Marks</b> : 100
<b>Course Code</b> : 20ME54I	<b>Duration</b> : 3 Hrs

**Instruction to the Candidate:** Answer one full question from each section.

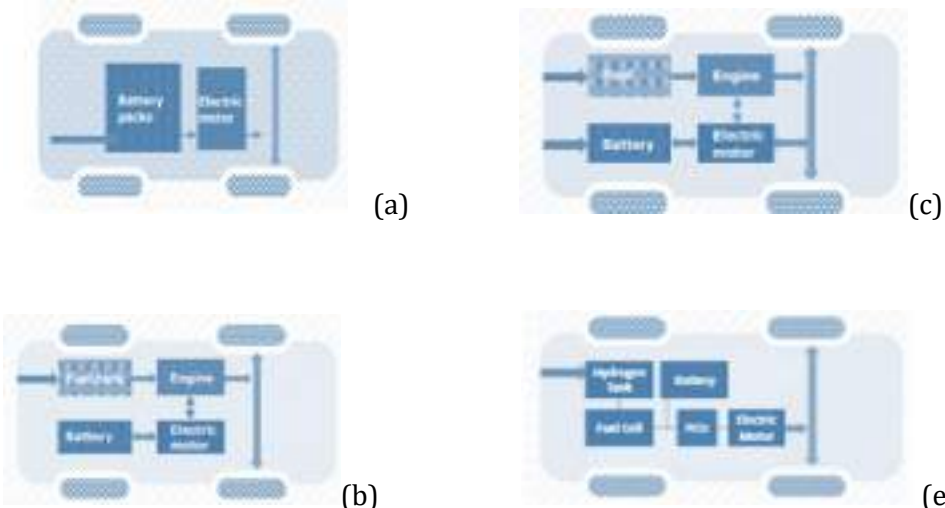
Q.No	Question	CL (L3/L4)	CO	Marks
<b>Section-1</b>				
1.a)	 <p>(a) (c)</p> <p>(b) (e)</p>	L3	1	10
<p>The above sketches represent different types of Electric vehicles. Identify them and prepare a comparison statement on different types of EV's. Suggest the best EV which will provide Zero emission.</p>				

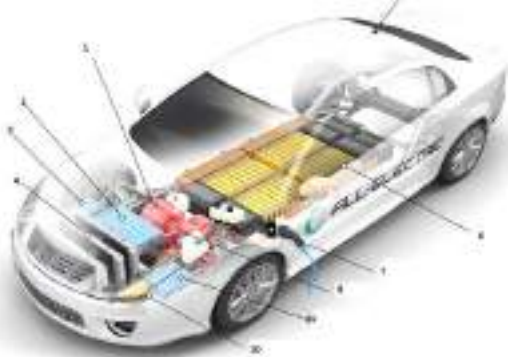
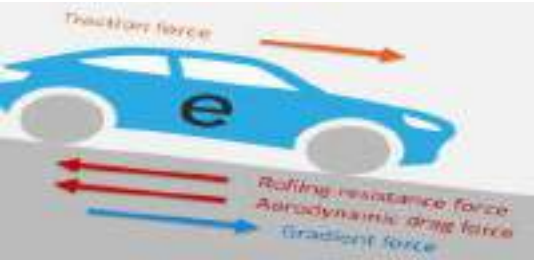
b)	It is debatable whether hydrogen EVs will dethrone battery-electric vehicles as the cars of the future, but it is an interesting technology with wide-ranging potential. In what way is the architecture of fuel cell electric vehicle (FCEV) different from Battery Electric vehicle.? Illustrate the working of FCEV.	L4			
2.a)		Identify the different components of an electric car: What is the role played by these components in EV?	L3		10
b)	According to a report by the European Union, the transport sector is responsible for nearly 28% of the total carbon dioxide (CO2) emissions, while the road transport is accountable for over 70% of the transport sector emissions. Therefore, the authorities of most developed countries are encouraging the use of Electric Vehicles (EVs). Do you think electric vehicles will provide solution to this problem? How do these electric vehicles work when compare to conventional vehicles	L4		10	
<b>Section-2</b>					
3.a)	<p>Analyse the diagram shown. How are these forces determined? What are the effects of these forces on Vehicle movement? How does power and torque overcome these resistances?</p> 	L3	2	10	

b)	When selecting drive wheel motors for e- vehicles, several factors must be considered to determine the maximum torque required. The following example presents vehicle design criteria: <ul style="list-style-type: none"> <li>▪ Gross vehicle weight (GVW): 35 lb</li> <li>▪ Weight on each drive wheel (WW): 10 lb</li> <li>▪ Radius of wheel/tire (Rw): 4 in</li> <li>▪ Desired top speed (Vmax): 1.5 ft/sec</li> <li>▪ Desired acceleration time (ta): 1 sec</li> <li>▪ Maximum incline angle (<math>\alpha</math>): 2 degrees</li> <li>▪ Worst working surface: concrete (good)</li> </ul> Choose the motors capable of producing enough torque to propel the above example vehicle, by considering the total tractive effort (TTE) requirement for the vehicle	L4		10
4.a)	How Power gets transmitted from Motor to wheels in Electric vehicles? Illustrate the working of the transmission system used electric vehicles.	L3		10
b)	The main objective of a vehicle suspension system is to reduce the discomfort sensed by passengers which arises from road roughness and to increase the ride handling associated with the pitching and rolling movements. Different suspension systems are available. Compare these suspension systems provided in EV's? Which transmission system do you think is more effective and why?	L4		10
<b>Section- 3</b>				
5.a)	A company is interested in converting the Internal Combustion Engine Vehicle to EV? They are in a dilemma of selecting a right type of electric motor. Compare different electric motors used in EV. From your comparison, Suggest a best Electric motor with justification	L4	3	10
b)	Conventional vehicle is propelled by a combustion engine that can only be fuelled by gasoline. This technology is well-established, and reliable, but consumes large amounts of gasoline—which can be costly in many ways. Also, releases large amount of exhaust gases. Which component in electric vehicle helps in overcoming this problem? Analyse the working of this component in electric cars?	L4		10

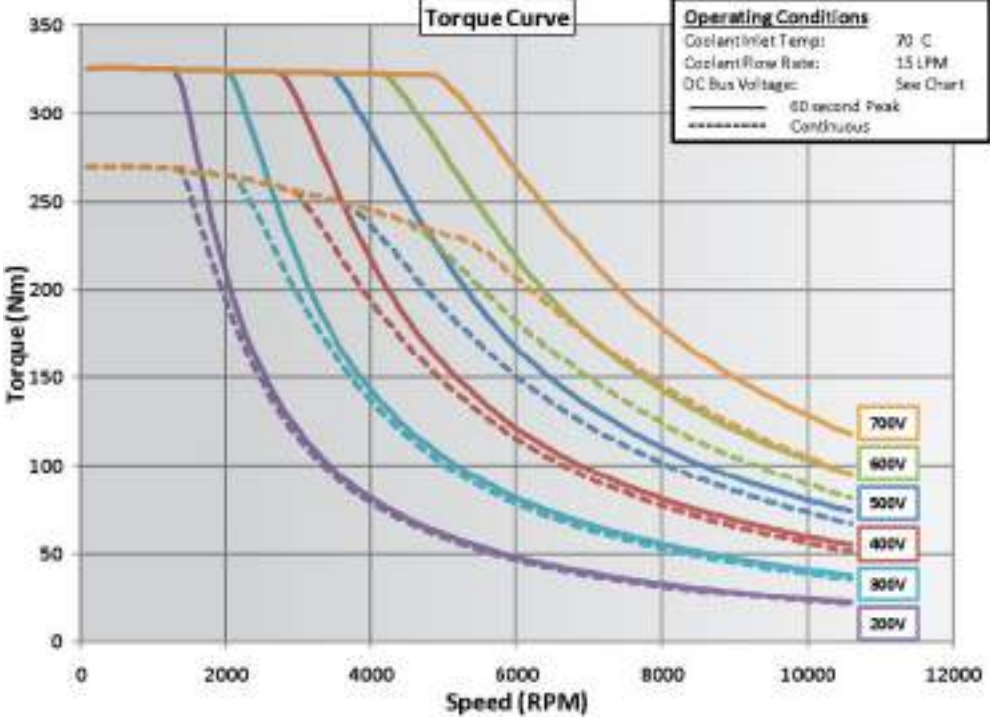
6.a)	 <p>The Torque and Speed characteristics of an electric motor is shown in the figure, interpret the graph and analyse how it is suitable for e-vehicles</p>	L4		10
b)	The motor control solution consists of the communication, diagnostics, and features like regenerative braking and power management capabilities. Analyse how the motor controller in EV controls the electric motors such as BLDC, induction motors, PMSM and Reluctance motors as per the requirements of a drive cycle.	L4		10
<b>Section-4</b>				
7.a)	The lithium-ion battery has established itself as the technology of reference in the world of electric cars. Compare the working principle of this battery with a lead acid battery with respect to material used for anode, cathode, electrolyte, and separator	L4	4	10
b)	"Lithium-ion batteries are preferred in EV due to their high energy per unit mass compared to other batteries. They also have the advantages of a high power-to-weight ratio, energy	L4		10

	efficiency, high-temperature performance, and low self-discharge. Present an argument to support this statement			
8.a)	The performance of an EV mainly depends on the health of a battery. Presently researchers are focusing on safety and enhanced performance of the battery. But one of the major issues is the corrosion of the battery terminals. What may be the reason for this? How can battery terminal corrosion be prevented?	L4		10
b)	Battery management systems (BMS) is used in electric vehicle to monitor health of the batteries which makes the operation more economical. Battery management system keeps the battery safe, reliable and increases the senility without entering damaging state. Analyse how BMS will maintain the state of the battery, voltage, current, ambient temperature in safe range	L4		10
<b>Section-5</b>				
9.a)	Assuming you are executing the project of installing the e vehicle charging stations in a metro city having considerable e vehicle density. Discuss the fundamentals you need to consider before installing EV charging stations?	L3	5	10
b)	Draw Basic charging Block Diagram of Charger and discuss the salient features of Slow charger, fast charger, and Rapid charger	L3		10
10.a)	In the old days, automotive systems were concentrated on a few nodes. Now, they're continuously evolving. 45 to 70 or 80 subsystems can exist in a car carrying out multiple functionalities. Communication between all these subsystems (for example ADAs, or telematics units) is essential for the overall implementation of the vehicle's features. Right from vehicle start-up till the driver leaves the car, all the subsystems continuously transmit their status to, as well as receive data from, other subsystems necessary to perform a task. In view of the above developments in EV technology, discuss the most widely used communication protocols in EV	L3		10
b)	Charge point operators and e-mobility service providers are facing challenges expanding internationally especially in dealing with different protocols, regulations, and multi-currencies, and integrating roaming capabilities into their networks. Provide an overview on EV Charging Industry Protocols so that right protocols are selected and adopted?	L3		10



**Scheme of Evaluation for SEE 2**

Sl. No	Description	Marks
<b>Problem statement</b>	Model an Electric vehicle by using simulation software and analyze the EV performance parameters such as a) Speed, Torque, Top speed reached, distance travelled b) Current, voltage for different drive cycles c) Vehicle dynamics like rolling resistance, air drag, frontal area, weight of the body etc on EV performance	<b>100</b>
1	Modelling an EV on Simulation software	40
2	Analyze EV performance parameters and write inference	25
3	Analyze Impact of vehicle dynamics on EV performance and write inference	25
4	Innovative changes in the Model	10
<b>Total</b>		<b>100</b>

# **Annexure**

## **HVAC Tender Document- Sample**

**MECHANICAL SECTION**  
**TENDER DOCUMENT**  
**FOR AIR CONDITIONING**

**Project** : **Training Facility Building.**

**Project Location** : **Pune**

## CONTENTS

<b><u>SR.NO.</u></b>	<b><u>TITLE</u></b>	<b><u>PAGE. NO.</u></b>
1.	Notice Inviting Tenders	3 to 5
2.	Form of Tender	6
3.	Scope	7
4.	Basic Guidelines to Bidder	8
5.	Special Conditions Of Contract	9
6.	Design data	10
7.	Clauses of Contract	11 to 25
8	Technical Specifications	26 to 93
9.	Testing & Balancing	94 to 101
10.	HVAC Electrification Scope	102 to 104
11.	Special Conditions for Erection Contract	105 to 107
12.	Additional Conditions	108 to 111
13.	Statutory Obligations	112
14.	List of Approved Make	113 to 114
15.	Equipment Schedules	115 to 119
16.	Bill Of Quantities	120 to 124
17.	Drawings	

## NOTICE INVITING TENDERS

### **Director**

*invites sealed tenders for Air conditioning work for them to be carried out for their building at Dr. Homi Bhaba Road, Pashan.Pune, Maharashtra.*

This facility is expected to be commissioned in **January' 2012**. The HVAC tender for this job is High side and low side Air Conditioning and Ventilations as per the specifications indicated elsewhere in the tender.

The scope of the vendor shall include selection of systems and equipments, supply, commissioning supported by appropriate documentation.

The equipment and system offered by vendor shall be user friendly for operation and maintenance and designed for complete personal safety and shall offer no health hazards.

The system offered shall be highly efficient with excellent performance level, continuous trouble free operations and with minimum BHP/TR.

1. The Tenderers are requested to give detailed sealed tender in their own forms in two bid i.e.  
Part –I Technical Bid.  
Part – II Commercial Bid

Both the sealed bid should be sent in another sealed envelope addressed to the **Director, Pune – 411008 . INDIA .** So as to reach **on or before 03 Oct' 2011.**

2. If a request is made to Pune for tender documents, a sum of Rs 1,000.00 (Rs One **Thousand Only**) for Indigenous supplier / Indian agents (Non-refundable) has to be paid in the form of Demand Draft drawn in favour of The Director, **Pune** enclosed in Technical Bid only.
3. You have to submit two separate bids in two separate envelopes and you may keep both the bid envelope in an envelope for sending us.

One envelope will contain only the **TECHNICAL SPECIFICATION** of the indented equipment.

Another envelope will contain only the financial bid in which price, maintenance, AMC etc. and any other information, which has financial implication, will only be given.

The main envelope will contain both the bids, should be super scribed with our tender enquiry No- **WS/HVAC/MTFB/2011 due on 03 Oct' 2011.**

4. The technical bid will be opened on the specified due date in the presence of bidders who wish to be present & the financial bids of only those bidders will be opened whose technical bid is found suitable by us.
5. The date and the time of opening of part –II (Commercial Bid) will be intimate only to pre-qualified and technically acceptable bidders for the item at a later date.

Last date and Time for receipt of Tender :-**Upto 12.30 hrs. On 03 Oct 2011.**

Date and Time for opening of Tenders: **At 15.00 hrs. On 03 Oct 2011.**  
(Part-I technical Bid Only)

6. The tenders shall be submitted in the following manner and shall contain details / documents as listed here in. Technical / Commercial Bid containing the following:
- 1) Complete sets of the tender document as issued, duly filled and signed by the bidders, and shall comprise of:
    - a) A confirmation of the design conditions.
    - b) Duly Filled in Technical Data Sheets.
    - c) Bill of quantities and rates with prices.
    - d) Equipment catalogue / literature.
    - e) Separate Commercial & Technical Deviation sheet, if any.
    - f) Confirmation of the commercial terms
7. Bids shall be kept valid for a period of 120 days from the due date indicated above.
8. Bidders shall quote in strict accordance with the requirements of this tender. Bidders are advised to avoid making technical and commercial deviations. Bidders shall note that unless any and all deviations they may wish to make from the specifications and other terms and conditions are listed in a separate deviation sheet, it shall be deemed that the bids are in strict accordance with the requirements of this inquiry.
9. Bidders must survey if they wish to, the site in consultation with CLIENT / CONSULTANT with prior appointment.
10. The owner does not bind himself to accept the lowest or any bid or a portion thereof without assigning any reason for/to split the contract during progress of work due to unsatisfactory work of any one vendor / contractor. Where more than one item is covered by this inquiry OWNER reserves the right to place orders for the various items with different bidders. OWNER also reserves the right to add or delete any item to the contract and the same shall be binding to the contractor / vendor.
11. All the rates mentioned in the tender shall be inclusive of all taxes / duties / levies / sales tax / Works contract Tax / Service Tax / Octroi duty / ESIC scheme for workers, transport charges etc.

12.This tender notice shall form a part of the contract.

13. This tender is not transferrable.

18. Conditional offer will not be considered.

The Director Pune 411108 (India) reserve the right to

Accept any tender in full or in part or to reject the lowest or any all tenders without assigning any reason.

FOR;

***Pune 411008.***

***Date: -----***

## FORM OF TENDER

Following Form of Tender to be filled in by the tenderer, **on their own letterhead** and to be submitted with tender documents.

1. Works to be carried out at :

**Pune 411008**

2. Name of the Bidder :

3. Registered Office Address :

4. Central Sales Tax Number :

State Sales Tax Number:

5. Nature of Work : Supply, Installation, Testing & Commissioning  
Of the Air-conditioning and Ventilation system.

6. Total Price Offered in Rs. : Rs.

Price in words. (Rupees \_\_\_\_\_ )

7. Validity of Quotation : 120 Days from **XXXXX**.

8. Performance Guarantee Period: 24 Months from the date of commissioning.  
(Defect Liability Period) certificate.

9. Work Completion Period: by -----**Months**.

10. Terms & Conditions & Scope of Work: As per Tender Document.

11. Partly Offer, Inadequate/Unclear information or any omission/deviation in the scope of work specifications, terms & conditions laid down in the tender documents make the tender liable for rejection.

I/We have carefully studied and understood all contents of this tender & aware of the scope and specifications of the work to be done and the local conditions and other factors bearing on execution of the work.

It is understood by me/us that the lowest or any tender will not necessarily be accepted.

Place:

Yours faithfully,  
Signature of Contractor  
With Company Seal.

Date:

Address:



## **SCOPE**

1. This specification covers the manufacture, testing at manufacturers works, supply and delivery, at site, installation, testing and commissioning of Air conditioning system for Multi Training Facility Building at “ Pune 411008.”
2. It is not the intent to specify completely herein all details of construction of the equipment. However, the equipment shall conform, in all respects, to high standards, of engineering and workmanship and be capable of performing in continuous commercial operation up to Vendor's guarantee in a manner acceptable to PURCHASER who will interpret the meaning of drawings and specification and shall have the power to reject the work or material which in his judgement, are not in full accordance therewith.

### **BASIC GUIDELINES TO THE BIDDER**

1. The contractor shall guarantee for the complete performance of the systems offered inline with the specification mentioned elsewhere in the document. It is mandatory for the bidder to carefully study the design specifications provided in this tender. Any deviation shall be highlighted while submitting the offer.
2. The drawings submitted in this tender are more or less in detail. However the necessary detail drawings including detail duct routing layout shall be submitted by the successful bidder. On completion of the job the contractor has to submit required no of copies and a CD of the as built drawings to the client
3. The bill of material format is only for guidance and shall be filled by the bidder. The bill of material thus filled shall form the basis of offer. Any deviation proposed by bidder shall be quoted as extra items.
4. The original tender shall be returned after duly filling the \*\* marks.
5. Price bid shall be submitted in the format attached to this tender. Additional items if any may be added as extra items.
6. The bidder shall submit their company profile and list of client along with the tender.
7. The pre bid meeting will be held on 21 Sept' 2011 at 15.00 Hrs Campus, Pune.

## **SPECIAL CONDITIONS OF CONTRACT**

All bidders should furnish their offer in the Document issued by this office only and it should be strictly as per stipulated Tender conditions. In case of any variance Tender may be rejected at the sole discretion of the clients.

In the event of there being any change in specification / other conditions having the financial implications the extent of such financial implications will be assessed by the consultant/client and weightage in the respect of the same will be added / subtracted to the quoted amount to arrive at the final Tender amount.

All material supplied at site will be inspected by the Client's Engineers / Consulting Engineer, prior to installation or fabrication.

Contractors who have done at least **1.0 Cr INR (10 Mn INR)** value HVAC work in past 3 years shall be considered for pre qualification.

## DESIGN DATA

### 1. Site Parameters

#### Gographical Location : Pune

10 Kms From Pune (approx), Maharashtra, India.

**Altitude** : 560 m above MSL

**Latitude** : 18.34 °N

**Daily Temperature Range** : 31 Deg F

#### 1. Outside Design Conditions:

Summer D.B.Temperature : 104 Deg. F  
W.B. Temperature : 76.0 Deg. F

Monsoon D.B.Temperature : 83 Deg.F  
W.B. Temperature : 79 Deg.F

#### 2. Inside Design Conditions: 24+/- 2 Deg C

The contractor shall visit and study the site on his own cost with prior permission from the client/owner. The submitted details shall guarantee the inside design conditions as specified. Any other information required by the contractor for verification shall be provided to him by the consulting engineer / the client.

## CLAUSES 1 to 37

### CLAUSE 1 - DEFINITIONS

1. **OWNER / PURCHASER** shall mean “M/s Indian Institute of Tropical Meteorology, Pune.” on whose behalf the enquiry is issued by the **ENGINEER / CONSULTANT** and shall include his successors and assigns, as well as his authorised offices / representatives.
2. **BIDDER** shall mean the firm / party who quotes against an enquiry.
3. **VENDOR / CONTRACTOR** shall mean the successful BIDDER whose Bid has been accepted by the **OWNER / PURCHASER** and on whom the ‘Contract’ or Purchase Order is placed by the **OWNER / PURCHASER** and shall include his heirs, legal representatives, successors and permitted assigns.
4. **“THE EQUIPMENT”** means machinery, equipment, materials, and other items to be supplied by the contractor pursuant to the contract.
5. **“THE WORK”** means all the duties, responsibilities and obligations to be discharged by the contractor pursuant to the contract.
6. **“THE CONTRACTORS EQUIPMENT”** means all machinery, apparatus, materials and equipments to be provided by the contractor pursuant to the contract for and in connection with the work **BUT NOT** forming or intending to form a permanent part of the plant.
7. **SUB - VENDOR / SUB - CONTRACTOR / SUB - FABRICATOR** shall mean the person named in the Contract undertaking a part of the work or any person to whom a part of the Contract has been sublet with the consent in writing of the **OWNER / PURCHASER** and shall include his heirs, legal representatives, successors and permitted assigns.
8. **MANUFACTURER** refers to a person or firm who is producer and furnisher of material or designer and fabricator of equipment's to either the **OWNER / PURCHASER** or the **VENDOR / CONTRACTOR** or both under the Contract.
9. **OTHERS** shall mean other successful **BIDDERS** whose Bids have been accepted by the **OWNER / PURCHASER** and to whom the orders have been placed by the **OWNER / PURCHASER** and shall include their heirs, legal representatives, successors and permitted assigns.
10. **INSPECTOR** shall mean the authorised representatives appointed by the **OWNER /PURCHASER** or the **ENGINEER / CONSULTANT** for purposes of inspection of materials / Equipment / Works.
11. **‘Project’** shall mean the project specified in the Scope.
12. **‘Site’** shall mean the actual place of the proposed ‘Project’ as detailed in the Specification or other place where work has to be executed under the Contract.

13. **'Month'** shall mean calendar month.
14. **Specification** shall mean collectively all the terms and stipulations contained in those portions of the Contract known as General Conditions, the specifications and such Amendments, Revisions, Deletions or Additions, as may be made in the Agreement and all written Agreements made or to be made pertaining to the method and manner of performing the work or to the quantities and qualities of the materials to be furnished under this Contract.
15. **'Bid'** shall mean the proposal / document that the **BIDDER** submits in the requested and specified form in the specification issued by the **OWNER/ PURCHASER**.
16. **'Plant Equipment'** and **'Work'** shall mean respectively the goods to be supplied and services to be provided by the **VENDOR / CONTRACTOR** under the Purchase order or Contract.
17. **'Contract'** or **Purchase Order'** shall mean the order and associated specifications executed by the **OWNER /PURCHASER** and the **VENDOR** including or other documents agreed between the parties or implied to form a part of the 'Contract'.
18. **Contract Price** shall mean, if there is a formal agreement the prices referred to in the agreement or if there is no formal agreement, the price agreed to be the value of the Contract.
19. Contract Period shall mean the period during which the Contract shall be executed as agreed between **VENDOR / CONTRACTOR** and **OWNER / PURCHASER** in the Contract.
20. 'Guarantee Period' shall mean the period during which the installed air-conditioning system & its 'Plant or 'Equipment' shall give the same performance as guaranteed by the **VENDOR** in the Schedule of Guarantee as in the 'Specification'.
21. 'Approved' and 'Approval' where used in the 'Specification' shall mean, respectively, approved by and approval of the **OWNER / PURCHASER** or the **ENGINEER /CONSULTANT**.
22. **CONSULTANT'S INSTRUCTIONS** shall mean any drawings and / or instructions oral and / or in writing, details, direction and explanations issued by the **ENGINEER / CONSULTANT** or the **OWNER / PURCHASER** from time to time during the 'Contract Period'.
23. **'CONTRACTOR'S Works'** or **MANUFACTURER'S Works** shall mean and include the land and other places which are used by the **VENDOR / CONTRACTOR / FABRICATOR** or **SUB - VENDOR / SUB - CONTRACTOR - SUB - FABRICATOR** for the manufacture of 'Equipment' or performing the Works.
24. 'Performance Tests' shall mean such tests as are prescribed in the 'Specification' to be done by the **VENDOR** before the plant is handed over to the **OWNER / PURCHASER**.
25. 'Virtual Completion' shall mean that all work is completed as directed and the 'Site' is cleared to the satisfaction of the **OWNER / PURCHASER** or the **ENGINEER / CONSULTANT**.
26. Words importing persons shall include Firm, Companies, Corporations and other Bodies, whether incorporated or not.

27. 'Drawings' shall mean all:

- (a) Drawings furnished by the **OWNER / PURCHASER** or the **ENGINEER / CONSULTANT** as a basis for proposals.
- (b) Supplementary drawings furnished by the **OWNER / PURCHASER** or The **ENGINEER / CONSULTANT** to clarify and to define in greater detail the intent of the Contract.
- (c) Drawings submitted by the **VENDOR** with his proposal provided such drawings are acceptable to the **OWNER / PURCHASER** or the **ENGINEER / CONSULTANT**.
- (d) Drawings furnished by the **OWNER / PURCHASER** or the **ENGINEER/CONSULTANT** to the **VENDOR** during the progress of the work, and
- (e) Engineering data and drawings submitted by the **VENDOR** during the progress of the work
- (f) Provided such drawings are acceptable to the **ENGINEER / CONSULTANT**.

#### **CLAUSE 2 – CONTRACTOR`S SERVICES**

- a) The Contractor shall supply the Equipment and provide execute, complete and maintain the work in accordance with the Contract.
- b) The Contractor shall be responsible for ensuring that the positions, levels and dimensions of the work are correct according to the Contract notwithstanding that he may have been assisted by the Owner in settling out the said positions, levels and dimensions.
- c) The work to be done under the Contract shall be executed with all the diligence and despatch and in the manner specified in the Contract and to the satisfaction of the Owner. The Contractor hereby undertakes that the work shall be ready for tests on completion not later than the date of completion.

#### **CLAUSE 3 – CONTRACT PRICE**

- a) The owner shall pay the Contractor the sum set out in the Price Schedule hereto increased or reduced by such sums (if any) as under the Contract are to be taken into account in ascertaining the Contract Price.
- b) The contractor shall credit the owner with the sum, which may become allowable or due under the contract at the times and in the manner herein specified.
- c) The rates and prices quoted by the Contractor are inclusive of all taxes, duties etc. as applicable.
- d) Octroi, if applicable at site, contractor shall mention it separately. Caparison will be is on landed cost at

#### **CLAUSE 4 – CONTRACTOR TO INFORM HIMSELF FULLY**

The Contractor shall be deemed to have examined the site and the nature of the work and to have fully satisfied himself with regard there to prior to entering into the Contract.

#### **CLAUSE 5 – FINANCIAL GUARANTEE FOR PERFORMANCE**

- (i) 10 % of the value of work done, shall be deducted from each R.A. Bill towards retention money. The Contractor shall, however, have the option of submitting Bank Guarantee for 10 % in lieu of cash retention. Bank Guarantee, if submitted, shall be valid for the full duration of defects liability period of 12 months reckoned from the date of handing over the complete works to us.
- (ii) 5% performance security of the cost of award has to be submitted to the institute in the form of D.D./Bank guaranty before starting the work.

#### **CLAUSE 6 – DRAWINGS AND DESIGNS**

All technical information, furnished to the Contractor by the Owner in connection with the work and as indicated by the Owner in writing at that time to be confidential, shall be treated as confidential by the Contractor and shall not be revealed to third parties, duplicated or used by the Contractor for any other purpose other than for this plant. This will, however, not be applicable to such information as :

Information which at the time of disclosure or thereafter become public knowledge provided that such information does not become public knowledge by reason of the Contractor's breach of the agreement.

Information which prior to disclosure hereunder was already in the Contractor's possession or in the possession of its employees then their use will be without violation of any secrecy obligation to the Owner.

Information which subsequent to disclosure hereunder is obtained by the Contractor from a third party who, to the best of the Contractor's knowledge is lawfully in possession of such information and is not subject to a secrecy obligation to the Contractor.

#### **CLAUSE 7 – PATENTS AND OTHER RIGHTS**

The Contractor shall fully indemnify the Owner against any action, claim or demand, costs of expenses arising from or incurred by reason of any infringement or alleged infringement of any letters, patent, registered design, trade mark or name copyright or other protected right in respect of the work or any arrangement system or method of using, fixing or working the Equipment authorised or recommended by the Contractor. In the event of any action being brought or any claim or demand being made against the Owner on account of any such matters as aforesaid, the Contractor shall immediately be notified thereof and he shall at his own expenses, fully co-operate with the Owner and shall do all that, the Owner may reasonably require to assist in the defence in such action or to resist such claim or demand.



The Owner shall not settle any such action or satisfy or comprise any such claim or demand without the consent in writing of the Contractor which consent will not be unreasonably withheld.

The Owner warrants on his part that any design or instruction furnished or given by him shall not be such as will cause the Contractor to infringe any letters, patent, registered, design, trade marks, or copyright in performance of the Contract.

#### **CLAUSE 8 – ROYALTIES**

All payments and royalties payable in respect of any letters, patent and other right whether payable in one sum or by installments or otherwise are included in the Contract Price and shall be paid by the Contractor as and when due to the person or persons to whom they shall be payable. The contractor shall indemnify the company from any such payments.

#### **CLAUSE 9 – ASSIGNMENT AND SUB-LETTING OF THE CONTRACT**

The Contractor shall not without the consent in writing of the Owner assign or transfer the Contract or the benefits of obligations thereof, or any part thereof, or enter into any sub-contract with any other

person, provided that this shall not effect any right of the Contractor to assign, either absolutely or by way of charges, any moneys due or to become due to him, or which may become payable to him under the Contract. Any such consent shall not relieve the Contractor from his obligations under the Contract.

#### **CLAUSE 10 – GUARANTEES**

- i) All equipment supplied and work done by the Contractor pursuant to the Contract shall be guaranteed by the Contractor to be of the new & first quality and workmanship and to be of expert design conforming to generally accepted international standards and to be sufficient size and capacity and of proper materials so as to fulfil in all respect the operating and other condition specified and to meet all the requirements specified in regard thereto.
- ii) If at any time during the execution of the work or during the maintenance period specified in Article 30 hereof, the Owner shall decide that any equipment supplied or work done by the Contractor fails in any respect to conform to the guarantee given by the Contractor in Article 10(i) hereof. The Owner may, as soon as, give the Contractor reasonable and practicable notice in writing / verbal of the respects in which the Equipment supplied or the work done has failed. At his own expenses, including reimbursement of all costs and expenses incurred by the Owner in connection therewith, replace any equipment and carryout any further work that may be necessary to ensure that the equipment supplied and the work done conforms to such guarantee.
- iii) If the Contractor fails within a reasonable time to take such steps as may be necessary to fulfil his obligations under Article 10 (ii) hereof then the Owner may, at the expense of the Contractor take such steps as may be necessary to ensure that the equipment supplied or the work done by the Contractor shall conform to such guarantee.
- iv) If any replacement of equipment or the work done by the Contractor pursuant to this Article shall be of such a nature to affect the efficiency thereof or any portion thereof, the Owner may give to the Contractor

notice in writing requiring that a test or tests shall be made in which event such tests shall be carried out at the expenses of the contractor.

#### **CLAUSE 11 – VARIATIONS AND OMISSIONS**

- i) The Contractor shall not alter any of the work except as directed in writing by the Owner, but the Owner shall have full power from time to time during the execution of the Contract by notice in writing to direct the Contractor to turn, to alter, amend, add to, or otherwise vary any of the work and the Contractor shall carryout such variation, and be bound by the Contract so far as applicable as though the said variation were stated in the Contract. In any case in which the Contractor has received any such direction from the Owner which either then , or in the opinion of the Contractor will later involve any increase or decrease in the Contract Price, the Contractor shall, within 7 days of such direction, advise the Owner in writing to that effect. The Owner shall thereupon approve in writing such variations which are to be given effect together with the amount of increase or decrease in the Contract Price on that account. The Contractor shall then give effect to such variations. The difference in costs due to such variations shall be added to or deducted from the Contract Price and paid in the same way as the Contract Price.
- ii) If, in the opinion of the Contractor, any such variation is likely to prevent or prejudice him from or in fulfilling any of his obligations under the Contract, he shall notify the Owner thereof, in writing and the Owner shall decide forthwith whether or not such variations shall be carried out. If the Owner amends his instructions in writing, the said obligations shall be modified to such an extent as may be agreed in writing between the Owner and the Contractor provided, however, that the Contractor may not call upon the Consultant to agree to any such variations as would, in any way, have the effect of modifying the obligations of the Contractor under the provisions of Article 7 and 10 hereof.
- iii) Where the rates for extra items cannot be derived from tender rates, the same shall be arrived at on the basis of cost of materials plus cost of labour plus 10% towards Overheads and Profits of the contractor. The Contractor shall submit all details, relevant rate analysis as demanded by the Owner/Consultant to enable them to arrive at the rates to be recommended. The owner decision will be final after considering his details.

#### **CLAUSE 12 – EXECUTION OF WORK IN INCLEMENT WEATHER**

The Contractor shall during, inclement weather carry out the work in accordance with the Contract and the Contractor shall not be entitled to any additional payment over and above the Contract Price by reason of his being unable to carry out the work owing to inclement weather.

#### **CLAUSE 13 – CONTRACTOR’S DEFAULT**

If the Contractor shall fail or neglect to execute the work with all due diligence and expedition, or shall refuse or neglect to comply with any reasonable orders given to him in writing by the Owner in connection with the work, or shall contravene the provisions of the Contract, the Owner may give notice in writing to the Contractor to make good such failure, neglect or contravention. Should the Contractor fail to comply with the notice, within the time specified in the notice, then the Owner shall be at liberty forthwith to execute such part of the works as the contractor may have failed or neglected to do all. Without prejudice to any other rights, the Owner may, under sub-contract, take the works wholly or in part thereof from the Contractor’s hands and contract with any other person to complete the work or

part thereof, and in that event the Owner shall have the free use of all Contractor's equipment and other things that may be at any time be on the site in connection with the work, without being responsible to the Contractor for fair wear and tear thereof, and to the exclusions of any right of the Contractor over the same. The Owner shall be entitled to retain and supply any balance which may be otherwise due, under the Contract to the Contractor or such part thereof as may be necessary to the payment of the cost of executing the said part of the work or of completing the work as the case may be and of meeting claims of third parties against the Owner and arising from or in consequence of the Contractor's failure, neglect refusal or contravention as aforesaid. If the cost of completing the work or executing a part thereof or of meeting claims of third parties as aforesaid shall exceed the balance due to the Contractor, the Contractor shall pay such excess to the Owner.

#### **CLAUSE 14 – BANKRUPTCY AND WINDING UP**

If the Contractor shall become bankrupt or insolvent, or have a receiving order made against him, or compound with his creditors, or being a corporation, commence to be wound up, not being a member's voluntary winding up for the purpose of reconstruction, or carry on its business under a receiver for the benefit of its creditors or any of them, the Owner shall be at liberty:-

- a) to terminate the Contract forthwith by notice in writing to the Contractor or to the receiver or liquidator or to any person in whom the Contract may become vested, and to act in the manner provided in Article 13 hereof as though the last mentioned notice had been the notice referred to in such Article and the work had been wholly taken out of the Contractor's hands, or
- b) to give such receiver, liquidator or other person the option of carrying out the Contract subject to his providing guarantee for the due and faithful performance of the Contract up to an amount to be agreed.

#### **CLAUSE 15 – INSPECTION AND TESTING**

- i) Representatives of the Owner shall be entitled at all reasonable times to inspect the work or any part thereof.
- ii) Whenever it is necessary to cover up any work in respect of which previous inspection is desired and the Contractor has been notified accordingly in writing, the Contractor shall give notice in writing to the Owner before the work is covered up. No such work shall be covered up or built upon unless it has been inspected and approved by the Owner or unless the Owner consents in writing to the being done without his previous inspection and approval.
- iii) On receiving notice from the Contractor that the work is ready for inspection, the Owner shall without unreasonable delay, attend for the purpose of inspecting the said work.
- iv) The Contractor shall uncover any part of the works or make openings for inspection as the Owner may direct and shall reinstate and make good such part to the reasonable satisfaction of the Owner.

#### **CLAUSE 16 - ORIGIN OF MATERIALS**

- i) The owner shall have the right, at any time, to call upon the Contractor for evidence of origin of raw materials and parts of equipments.

- ii) All goods or materials supplied or used shall be of first class quality of the grade specified.

**CLAUSE 17 - MILL CERTIFICATES**

All Mill Certificates covering physical and analytical tests shall be produced as called for by the owner.

**CLAUSE 18 - TEST CERTIFICATES**

The Contractor shall provide specified number of test certificates and/or material analysis certificates and/or radiographic examination reports as called for by the Owner.

**CLAUSE 19 - ACCESS TO AND POSSESSION OF THE SITE**

- i) Subject to paragraph (iii) of this Article, access to and possession of the site shall be afforded to the Contractor by the Owner in reasonable time, and except in so far as, the Contractor may provide to the contrary the, Owner shall provide a road suitable for the transport of the equipment from the nearest public thoroughfare or railhead available to the site.
- ii) In the execution of the work, no persons other than the Contractor's employees shall be allowed on the site, except by the written permission of the Owner, but facilities to inspect the works at all times shall be afforded to the Owner and his representatives.
- iii) The access to possession of the site referred to in paragraph (i) hereof shall not be exclusive to the contractor but only such as shall enable him to execute the work. The Contractor shall offer to the Owner other Contractors and sub-contractors every reasonable facility for the execution of work concurrently with his own.
- iv) Unless otherwise provided in the Contract, the owner shall give the Contractor facilities for carrying out the work on the site continuously during the normal working hours generally recognized in the district. The Owner may, after consulting with the Contractor direct that the work, shall be done at other times if it shall be practicable in the circumstances for the work to be done and the extra cost of such work (if any) shall not be added to the Contract price.
- v) The Contractor shall arrange his own source of electricity and water that may be required for any testing purpose or for any other purpose at his own cost.
- vi) The contractor shall construct his site office provided with furniture, telephone, fax at the space allocated within the site at his own cost.
- vii) The Contractor shall make arrangements for shelters/labour colony for his workmen at his own cost. No space is available at site.

**CLAUSE 20 – CONTRACTOR'S EQUIPMENT**

- i) The Contractor shall at his own expense, provide all equipment necessary to execute and complete the work. If any equipment is available at the site, the contractor may with the written consent of the Owner, use the same on payment of any necessary charges.
- ii) All contractor's equipment shall be used solely for the purpose of the work and shall not be taken away by the contractor while it is required on the site for the purpose of the work without the permission in writing of the Owner and the contractor shall be liable for the loss of, destruction thereof or damage thereto. If there shall be due, owing or accruing to the Owner from the Contractor any money under or in respect of the Contract the Owner shall be at liberty at the cost of the Contractor to sell and dispose of any such Contractor's equipment as the Owner shall think fit, and to apply the proceeds in or towards the satisfaction of such moneys as aforesaid.

#### **CLAUSE 21 – CONTRACTOR'S REPRESENTATIVE & WORKMEN**

- i) The Contractor shall employ one or more competent representatives, whose name or names shall have previously been communicated in writing to the Owner by the Contractor to superintend the carrying out of the work. The said representative shall be present on the site during working hours and orders or instructions which the owner may give to the said representative shall be deemed to have been given to the Contractor.
- ii) The Owner shall be at liberty, by notice in writing to the contractor, to object to any representative or persons employed by the contractor in execution of or otherwise about the work, whose presence at site in the opinion of the Owner is not in the interest of the work or is prejudicial to the interest of the Owner, the Contractor shall remove such person from the site forthwith.
- iii) The Owner shall be given the opportunity to approve the employment of casual labour hired for the work.
- iv) The contractor and his employees shall abide by the site working conditions referred to in the third Schedule hereto.
- v) The Contractor shall immediately notify the Owner in writing of any labour dispute affecting the work. Such notice shall describe the nature of the labour dispute and the actions to be taken by the Contractor to settle the dispute.

#### **CLAUSE 22 – LIABILITY FOR ACCIDENTS & DAMAGE & INSURANCE**

- i) The Contractor shall during the execution of the work, properly cover up and protect any part of the work liable to injury by exposure to the weather and shall take every reasonable precaution against accident or injury to the work from any cause.
- ii) All Contractors' equipment shall be at the sole risk of the Contractor.
- iii) The Contractor shall insure all his personnel employed for the execution of the work against any personal injury that may be sustained by them as a result of the execution of the work and present

satisfactory evidence that such insurance is in force. The insurance cover shall be for adequate amount prescribed by statutory Authorities.

- iv) The Contractor shall at all times indemnify the Owner against all claims, damages or compensation under the provisions of Payment of Wages Act 1936, Minimum Wages Act 1948, Employees Liability Act, 1938, the Workman's Compensation Act, 1923, Industrial Dispute Act 1947 and the Maternity Benefit Act, 1961 or any modification thereof any other similar act, law and rules made there under from time to time.
- v) The Contractor shall be responsible for Workman's Compensation Insurance and all other statutory requirements in regards to the personnel in the contractor's employment.
- vi) The Contractor shall ensure that similar insurance policies are taken out by his sub-contractors (if any) and shall be responsible for any claims or losses to the Owner resulting from their failure to obtain adequate insurance protection in connection thereof.
- vii) All formalities and legal requirements in regard to ESI coverage for the Contractor's workmen working in the plant is solely the responsibility of the Contractor including what is required for the Factory Inspectorate.
- viii) Any of contractors or sub contractors persons causes damage of equipment or property of the company, the contractor will be solely held responsible for the cost of consequences thereof.

#### **CLAUSE 23 – POSTPONEMENT OF COMPLETION DATE**

- i) Neither the Owner nor the contractor shall be considered in default in the performance of his obligations hereto if such performance is prevented or delayed by circumference of Force Majeure as herein defined then in such an event the concerned party shall immediately give notice in writing to the other parties of the existence of Force Majeure, together with the evidence relied upon and the postponement to the date of completion shall be mutually agreed by all the parties.
- ii) For the purpose of this article Force Majeure shall mean and be limited to the following :
  - a) any war or hostilities
  - b) any riot or civil commotion
  - c) Any earthquake, flood, tempest, lightning or other natural physical disaster.
  - d) any accident, fire or explosion on the site not caused by the negligence of the Contractor.
  - e) any strike exceeding 10 days in duration affecting the performance of the contractual obligations hereunder.
  - f) any law or order of any government or government department or other authority which delay or impede the Contractor in the execution of the work.

#### **CLAUSE 24 – PENALTY ON LATE COMPLETION**

In the event of the contract work getting delayed due to reasons attributable to the Contractor, the Owner shall be levying the penalty at the rate of 1% per week to the maximum of 10% of the contract value.

#### **CLAUSE 25 – TEST ON COMPLETION**

The Contractor shall carry out tests on completion of work as specified in the Tender Document.

#### **CLAUSE 26 – TAKING OVER**

- i) As soon as the work has been completed in accordance with the contract (except in minor respects that do not affect their use for the purpose for which they are intended and except for the maintenance thereof as provided in CLAUSE 29 hereof) and have passed the tests on mechanical completion, the Owner shall issue a Certificate (hereinafter called a “TAKING OVER CERTIFICATES”) in which he shall certify the date on which the work has been so completed and has passed the said tests and the Owner shall be deemed to have taken over the work on the date so certified, but the issue of a TAKING OVER CERTIFICATE shall not operate as an admission that the work has been completed in every respect. In the event of the work being divided by this contract into two or more section, the Owner shall be entitled to take over any section before the other or others and thereupon the Owner shall issue a TAKING OVER CERTIFICATE in respect thereof. If by agreement between the Owner and the Contractor any portion of the work (other than a section or sections) shall be takeover before the reminder of the work, the Owner shall issue a TAKING OVER CERTIFICATE in respect of that portion.
- ii) If by reason of any default on the part of the Contractor, TAKING OVER CERTIFICATE has not been issued in respect of every portion of the work within 15 days of the date of completion, the Owner shall be at liberty to use the work or any portion thereof in respect of which a TAKING OVER CERTIFICATE has not been issued, provided that the work or the portion so used as aforesaid shall be reasonably capable of being used and the Contractor shall be afford reasonable opportunity of taking such steps as may be necessary to permit the issue of the TAKING OVER CERTIFICATE.
- iii) All system shall be handed over together & taking over certificates obtained. The Job can be treated as complete only when taking over certificates for all the systems are issued.

#### **CLAUSE 27 – SUSPENSION OF WORK**

- i) The Contractor shall, on the written order of the Owner, delay or suspend the progress of the work for such time or times and to such extent and in such manner as the Owner may specify.
- ii) All reasonable expenses incurred by the Contractor by reason of such delay or suspension by the Owner (otherwise than in consequence of some default on the part of the Contractor) shall be added to the Contract price provided that no claim shall be made under this Article, unless the Contractor has, within a reasonable time after the event giving rise to the claim, give notice in writing to the Owner of his intention to make such claims.



## **CLAUSE 28 – TERMINATION**

- i) The Owner may, for any reason whatsoever, at any time, by notice in writing to the Contractor terminate the Contract.
- ii) In the event of a termination pursuant to paragraph (i) of this CLAUSE :-
- iii) The Contractor shall carry out instruction of the Owner in connection with such termination including the cancellation of orders and the termination of contracts which the Contractor may have placed with others.
- iv) The Owner shall pay the Contractor for all materials used and work executed pursuant to the contract, but unpaid at the date of such termination together with any costs necessarily incurred by the Contractor in connection with the work as a result of such termination, provided that the Owner shall not be liable for any business loss or damage suffered by the Contractor as a result of such termination.
- v) The Contractor shall upon receiving notice from the Owner in accordance with paragraph (i) of this Article, notify the Owner within a reasonable time of the sums for materials used and work executed as mentioned in paragraph (ii) (b) of this Article.

These sums and all terms and conditions of termination pursuant to this Article shall be agreed in writing between the Owner and the Contractor.

- vi) Upon termination of the Sub-Contract pursuant to this Article, all obligations of the parties hereto shall cease except as to the liabilities of either part to the other for obligation accrued to the date of such termination.

## **CLAUSE 29 – MAINTENANCE PERIOD**

For a period of 24 months, after the work or any portion thereof has been taken over, the Contractor shall be responsible for making good with all possible speed and free of all costs and expenses to the Owner, any defects in the work arising from faulty or defective equipment, bad workmanship or from failure of the Contractor to carry out his obligations under the Contract.

## **CLAUSE 30 – PAYMENTS DUE FROM THE CONTRACTORS**

All costs, damages or expenses for which the Contractor is liable under the Contract may be deducted from money due or becoming due to the Contractor or may be recovered by action of law or arbitration pursuant to CLAUSE 33.

## **CLAUSE 31 – TERMS OF PAYMENT**

70% Against Supply of Material/ Equipment at site.  
20% Against satisfactory Commissioning/ Demonstration.  
10% Against Bank guarantee valid for 24 Month.



## **CLAUSE 32 – STATUTORY AND OTHER REGULATIONS**

The Owner shall when requested in writing afford reasonable assistance to the Contractor in obtaining information as to the local conditions.

The Contractor shall not in the performance of the Contract in any manner endanger the safety or unlawfully interfere with the convenience of the public.

## **CLAUSE 33 – ARBITRATION**

- i) If at any time any question, dispute, or difference shall arise between the Owner and the Contractor under or in connection with the Contract either party shall as soon as reasonable practicable give to the other, notice in writing of the existence of such question, dispute or difference specifying its nature and the point at issue and the same be referred to arbitration in accordance with the provision of the Indian Arbitration Act 1940. The award of such arbitration shall be final and binding on the parties hereto.
- ii) Performance of the Contract shall continue during arbitration and any subsequent proceeding.
- iii) The venue of all arbitration shall be Pune.

### **1.2 CLAUSE 34 – RECOURSE**

The Owner shall have recourse to the Contractor for any costs, claims, demand, proceedings, damages and expenses whatsoever arising out or in connection with any failure of the Contractor to perform any of his obligations under the terms of the Contract.

## **CLAUSE 35 – ADVERTISING**

No advertising, publicity matter or other literature in relation to the Contract or the work is to be published or utilised by the Contractor except with the prior written permission of the Owner.

## **CLAUSE 36 – PRICES**

All prices shall be fixed for the duration of the Contract and shall not be subject to escalation of any description unless stated otherwise in schedule of rates.

## **CLAUSE 37 – CONSTRUCTION OF THE CONTRACT**

- i) The Contract to the exclusions of all other agreements, statements or representation whether oral or written constitutes the full agreement between the parties hereto for the work to be performed hereunder.
- ii) No variation to the terms of the Contract shall be valid unless it is made in writing and signed on behalf of both the Owner and the Contractor by their respective authorised representatives.
- iii) The Contract shall be constructed in accordance with and governed by Indian Law.
- iv) Where general conditions of Contract are in conflict with schedules annexed to the Contract the latter shall govern.

**\* ARBITRATOR**

The Arbitrator will be the owner.

The names of the arbitrator will be selected from one of the following disciplines, in order of preference.

- a) Retired High Court / Supreme Court Judges, who have experience in handling Arbitration cases.
- b) Members of the Council of Arbitration.
- c) Fellow of Institution of Engineers.
- d) Eminent retire Chief Engineers from State / Center / P.W.D. / Public Sector undertakings.
- e) As per directives of Government of India.

For the purpose of appointing the sole Arbitrator referred to above, the Appointing Authority will send within thirty days of receipt by him of the written aforesaid notice to the contractor.

The contractor shall on receipt by him of the names as aforesaid, select any one of the persons named to be appointed as a sole Arbitrator and communicate his name to the Appointing Authority within thirty days of receipt by him of the names. The Appointing Authority shall there upon without any delay appoint the said person as the sole Arbitrator. If the Contractor fails to communicate such selection as provided above within the period specified, the Appointing Authority should make the selection and appoint the selected person as the sole Arbitrator.

If the Appointing Authority fails to send to the contractor the panel of three names as aforesaid within the period specified, the contractor shall send to the Appointing Authority a panel of three names of persons who shall all be unconnected with either party. The appointing Authority shall on receipt by him of the names as aforesaid select any one of the persons named and appoint him as the sole Arbitrator. If the Appointing Authority fails to select the person and appoint him as the sole Arbitrator within 30 days of receipt by him of the panel and inform the contractor accordingly, the contractor shall be entitled to appoint one of the persons from the panel as the sole Arbitrator and communicate his name to the appointing Authority.

If the Arbitrator so appointed is unable or unwilling to act or resigns his appointment or vacates his office due to any reason whatsoever another sole Arbitrator shall be appointed as aforesaid.

The work under the Contract shall, however continue during the arbitration proceedings and no payment due or payable to the contractor shall be withheld on account of such proceedings.

The Arbitrator shall be deemed to have entered on the reference on the date he issues notice to both the parties fixing the date of the first hearing.

The Arbitrator may from time to time, with the consent of the parties, enlarge the time for making and publishing the award.

The Arbitrator shall give a separate award in respect of each dispute or difference referred to him. The Arbitrator shall decide each dispute in accordance with the terms of the contract and give a reasoned award. The venue of arbitration shall be such place as may be fixed by the Arbitrator in his sole discretion.

The fees, if any, of the Arbitration shall, if required to be paid before the award is made and published, be paid half by each of the parties. The costs of the reference and of the award including the fees, if any, of the Arbitrator who may direct to and by whom and in what manner, such costs of any part thereof shall be paid and may fix or settle the amount of costs to be so paid.

**The award of the Arbitrator shall be final and binding on both the parties. Subject to aforesaid the provisions of the Arbitration Act 1940 or any statutory modification or re-enactment thereof and the rules made there under, and for the time being in force, shall apply to the arbitration proceeding under the clause. In all cases where the amount of the claim in dispute is Rs.75,000/- (Rupees Seventy Five Thousand Only) and above, the arbitrator shall give reasons for the award.**

It is also a term of the contract that if contractor (s) do / does not make any demand for arbitration in respect of any claim (s) within 90 days of receiving intimation from owner /architect that the bill after due verification is passed for payment of a lesser amount, or otherwise the contractor's right under this agreement to refer to arbitration shall be deemed to have been forfeited and owner shall be relieved and discharged of their liability under this agreement in respect of such claim (s). Further, it is agreed that for the purpose of this clause, such notice is deemed to have been received by the contractor (s) within 2 days of posting of the letter by owner or when delivered by hand immediately after receipt thereof by the Contractor (s), whichever is earlier. Further, a letter signed by the official's owner that the letter was so posted to the contractor (s) shall be conclusive.

I / We hereby declare that I / We have read and understood the above terms and conditions and that we shall abide if the work is awarded to us. I / we shall achieve inside design conditions at any given time.

**DATE:**

**SIGNATURE OF TENDERER.**

## TECHNICAL SPECIFICATIONS

### 1.0 Scope of Work

1.0 The Scope of work covers Design, Engineering, Manufacturing/Supply, Site Fabrication Erection Testing, Commissioning, of Air-conditioning and Ventilation System at . their Building at the following site.

Site Address :-

Pune 411008.

The following reference drawings are attached.

S.NO.	DRG.NO.	DESCRIPTION
1	T_705_FPBP_DU	HVAC Layout for basement Level
2	T_705_FP00_DU	HVAC layout Ground Floor
3	T_705_FP01_DU	HVAC layout First Floor
4	T_705_FPRV_DU	HVAC layout Terrace
5	T_705_DE01_00	HVAC Typical support details

The Air-conditioning equipments and installations shall conform to Indian Standards whenever applicable. The applicable Indian Standards are :

- a) IS 3615 : Glossary of terms used in Refrigeration and Air-conditioning.
- b) IS 325 : Three phase induction motor.
- c) IS 1239 : Mild steel tubes, tubular and other wrought steel fittings.

- d) IS 639 : Steel pipe flanges.
- e) IS 277 : Galvanised sheet steel.
- f) IS 737 : Wrought aluminum and aluminum alloy sheet and strip for general engineering purpose.
- g) IS 655 : Metal air ducts.
- h) IS 732 : Code of practice for electrical wiring and fittings for buildings.
- i) IS 900 : Code of practice for installation and maintenance of induction motors.
- j) IS 1248 : Direct acting electrical indicating instruments.
- k) IS 6392 : Steel pipe flanges.
- l) IS 1367 : Technical supply conditions for threaded steel fasteners.
- m) IS 3588 : Axial flow fans electric.
- n) IS 4894 : Centrifugal fan.
- o) IS 2074 : Ready mixed paint.
- p) IS 2208 : HRC cartridge fuse links upto 650 V.
- q) IS 1554 : PVC insulated (heavy duty) electrical cables for working voltages upto and including 1100 V.
- r) IS 659 : Air-conditioning safety code.
- w) IS 616 : Mechanical refrigeration safety code.

**Item wise Technical Specification is given here after in respective chapters.**

**CHILLER SPECIFICATIONS**

**CONTENTS**

1.0	GENERAL .....	29
1.1	General Information .....	29
2.0	COMPRESSORS .....	30
3.0	MOTOR DRIVELINE .....	30
4.0	LUBRICATION SYSTEM .....	30
5.0	EVAPORATOR .....	30
6.0	CONDENSER .....	30
7.0	REFRIGERANT SYSTEM .....	31
8.0	GRAPHICAL CONTROL PANEL .....	31
8.1	General .....	31
8.2	Control panel .....	31
8.3	The chiller control panel shall also provide .....	31
9.0	COMPRESSOR MOTOR STARTER .....	35
10.0	MISCELLANEOUS ITEMS .....	35
11.0	INSTALLATION .....	35

## **1.0 GENERAL**

### **1.1 General Information**

- 1.1.1 Each unit will be completely factory-packaged including evaporator, condenser, subcooler, oil separator, compressor, motor, lubrication system, micro-computer control center, and all interconnecting unit piping and wiring. The chiller shall also give Lon works / Bacnet protocol card / outlet to enable its connection to the BMS System
- 1.1.2 Water side shall be designed for 150 psig working pressure. Power shall be supplied to the compressor motor at 400 volts – 3 phase - 50 Hertz and controls at 215 volts – 1-phase - 50 Hertz. The chiller shall use R-134A./R-407C refrigerant gas. The power shall be provided at at one point only. The further distribution for multi compressors / condensers fan and any other devise shall be taken care by the supplier.
- 1.1.3 Each unit will be completely factory packaged including evaporator, condenser, compressor, motor, lubrication system, Microprocessor Control centre and all interconnecting unit piping and wiring. The chiller will be painted prior to shipment.

The supplier shall submit the computer software generated test parameters sheets of the testing before the despatch of the chillers at the points and conditions specified in tender agreement. The testing will be done in presence of clients representative at the test facility location at tender specified ambient temperature. The test parameters achieved during the witness testing at the testing facility at the specified ambient and at specified points ,in the presence of clients representative shall comply with the technical specification submitted by supplier without any negative tolerance in capacity of the chiller and positive tolerance in Power Consumption Values.

- 1.1.4 The initial charge of refrigerant and oil will be supplied for each unit including anti vibration mounts for base frame & flexible bellows for chiller inlet & outlet connections.

## **2.0 COMPRESSORS**

- 2.1.1 The compressor will be a rotary screw type. The compressor housing will be of cast iron, precision machined to provide minimal clearance for the rotors. The rotors will be manufactured from forged steel and use asymmetric profiles. The compressor will incorporate a complete anti-friction bearing design to reduce power and increase reliability.
- 2.1.2 Capacity control will be achieved by use of a slide Valve to provide fully modulating control from 100% to 10% of full load. The slide valve will be actuated by oil pressure, controlled by external solenoid valves through the micro-computer control centre.

## **3.0 MOTOR DRIVELINE**

- 3.1.1 The motor shall be, continuous duty, squirrel cage induction type, and will have an open drip-proof enclosure.
- 3.1.2 Motor full-load amperes at design conditions will not exceed motor nameplate (FLA). Motor will be designed for use with the type starter specified. Motor will be factory - mounted and directly connected to the compressor to provide compressor/motor alignment.

## **4.0 LUBRICATION SYSTEM**

- 4.1.1 An adequate supply of oil will be available to the compressor at all times. During operation, oil will be delivered by positive system pressure differential or full-time operation of an oil pump.

## **5.0 EVAPORATOR**

- 5.1.1 Evaporator will be of the shell-and-tube, flooded or DX type designed for 300 psig working pressure on the refrigerant side, and will be tested in accordance with ASME code or equivalent. The shell will be fabricated from rolled carbon steel plate with fusion welded seams; have carbon steel tube sheets, drilled and reamed to accommodate the tubes; and intermediate tube supports spaced no more than four feet apart. The refrigerant side will be designed, tested and stamped in accordance with the ASME Boiler and Pressure Vessel Code, Section VIII - Division 1 or equivalent. Tubes shall be high-efficiency, internally and externally enhanced type having plain copper lands at all intermediate tube supports to provide maximum tube wall thickness at the support area. Each tube will be roller expanded into the tube sheets providing a leak - proof seal, and be individually replaceable. Water velocity through the tubes will not exceed 12 fps. A liquid level sight glass will be located on the side of the shell to aid in determining proper refrigerant charge. The evaporator will have a refrigerant relief device to meet the requirements of the ASHRAE 15 Safety Code for Mechanical Refrigeration or equivalent. The evaporator tubes shall be internally coated with anti corrosive coat.

## **6.0 CONDENSER**

- 6.1.1 Condenser will be of the air cooled type complete with finned tube design, designed for 300 psig working pressure on the refrigerant side, and be tested in accordance with ASME code or equivalent. The tube material shall be copper & aluminium fins. A refrigerant sub cooler will be provided for improved cycle efficiency. The refrigerant side will be designed, tested and stamped in accordance with the ASME Boiler and Pressure Vessel Code, Section VIII - Division 1 or equivalent. The condenser fans shall be silent design with motor capable of outdoor application (IP-55). The condenser will have refrigerant relief devices to meet the requirements of the ASHRAE 15 Safety Code for Mechanical Refrigeration or equivalent.



## **7.0 REFRIGERANT SYSTEM**

- 7.1.1 Refrigerant flow to the evaporator will be metered by a single fixed orifice with a solenoid bypass to accommodate varying head conditions.
- 7.1.2 The condenser tubes will be capable of storing the entire system refrigerant charge during servicing. Isolation from the rest of the system will be by manually operated isolation valves located at the inlet and outlet of the condenser. Additional valves will be provided to facilitate removal of refrigerant charge from the system.

## **8.0 GRAPHICAL CONTROL PANEL**

### **8.1 General**

- 8.1.1 The chiller shall be controlled by a stand-alone microprocessor based control centre. The chiller control panel shall provide control of chiller operation and monitoring of chiller sensors, actuators, relays and switches.

### **8.2 Control panel**

- 8.2.1 the control panel shall include a 10.4 in. diagonal colour liquid crystal display (LCD) surrounded by “soft “ keys which are redefined based on the screen displayed at that time. This shall be mounted in the middle of a keypad interface and installed in a locked enclosure. The screen shall detail all operations and parameters, using a graphical representation of the chiller and its major components. Panel verbiage shall be available in other languages as an option with English always available. Data shall be displayed in either English or Metric units. Smart Freeze Point Protection shall run the chiller at 36.00 °F leaving chilled water temperature, and not have nuisance trips on low water temperature. The sophisticated program and sensor shall monitor the chiller water temperature to prevent freeze up. When needed Hot Gas Bypass is available as an option. The panel shall display countdown timer messages so the operator knows when functions are starting and stopping. Every programmable point shall have a pop-up screen with the allowable ranges, so that the chiller can not be programmed to operate outside of its design limits.

The chiller control panel shall also provide

System operating information including: Return and leaving chilled water temperature

- i. Entering and leaving condenser air temperature
- ii. Evaporator and condenser saturation temperature
- iii. Oil pressure at compressor and oil filter differential
- iv. Percent motor current
- v. Compressor discharge temperature
- vi. Oil temperature
- vii. Percent slide valve position
- viii. Operating hours
- ix. Number of unit starts

8.2.2 Digital programming of set points through the universal keypad including:

- i. Leaving chilled water temperature
- ii. Percent current limit
- iii. Pull-down demand limiting
- iv. Six-week schedule for starting and stopping the chiller, pumps etc.,
- v. Remote reset temperature range

8.2.3 Status messages indicating:

- i. System ready to start
- ii. System running
- iii. System coast down
- iv. System safety shutdown-manual restart
- v. System cycling shutdown-auto restart
- vi. System prelube
- vii. Start inhibit

8.2.4 The text displayed within the system status and system details field shall be displayed as a color coded message to indicate severity: red for safety fault, orange for cycling faults, yellow for warnings, and green for normal messages.

8.2.5 Safety shutdowns enunciated through the display and the status bar, and consist of system status, system details, day, time, cause of shutdown, and type of restart required. Safety shutdowns with a fixed speed drive shall include:

- i. Evaporator – low pressure
- ii. evaporator – low pressure – smart freeze
- iii. evaporator – transducer or leaving liquid probe
- iv. evaporator – transducer or temperature sensor
- v. condenser – high pressure contacts open
- vi. Condenser – high pressure
- vii. Condenser – pressure transducer out of range
- viii. Auxiliary safety – contacts closed
- ix. Discharge – high temperature
- x. Discharge – low temperature
- xi. Oil – high temperature
- xii. Oil – low differential pressure
- xiii. Oil – low differential seal pressure
- xiv. Oil or condenser transducer error
- xv. Oil – clogged filter
- xvi. Oil – high pressure
- xvii. Oil – separator – low level
- xviii. Control panel – power failure
- xix. Watchdog – software reboot

- 8.2.6 Cycling shutdowns enunciated through the display and the status bar, and consists of system status, system details, day, time, cause of shutdown, and type of restart required. Cycling shutdowns with a fixed speed drive shall include:
- i. Multiunit cycling – contacts open
  - ii. System cycling - contacts open
  - iii. Control panel - power failure
  - iv. Leaving chilled liquid - low temperature
  - v. Leaving chilled liquid - flow switch open
  - vi. Condenser – flow switch open
  - vii. Motor controller – contacts open
  - viii. Motor controller – loss of current
  - ix. Power fault
  - x. Control panel - schedule
- 8.2.7 Security access to prevent unauthorized change of set points, to allow local or remote control of the chiller, and to allow manual operation of the prerotation vanes and oil pump. Access shall be through ID and password recognition, which is defined by three different levels of user competence: view, operator, and service.
- 8.2.8 Trending data with the ability to customize points of once every second to once every hour. The panel shall trend up to 6 different parameters from a list of over 140, without the need of an external monitoring system.
- 8.2.9 The operating program stored in non-volatile memory (EPROM) to eliminate reprogramming the chiller due to AC power failure or battery discharge. Programmed set points shall be retained in lithium battery-backed RTC memory for a minimum of 1 years with power removed from the system.
- 8.2.10 A fused connection through a transformer in the compressor motor starter to provide individual over-current protected power for all controls.
- 8.2.11 A numbered terminal strip for all required field interlock wiring.
- 8.2.12 An RS-232 port to output all system operating data, shutdown / cycling message, and a record of the last 10 cycling or safety shutdowns to a field-supplied printer. Data logs to a printer at a set programmable interval. This data can be preprogrammed to print from 1minute to 1day.
- 8.2.13 The capability to interface with a building automation system to provide:
- i. Remote chiller start and stop
  - ii. Remote leaving chiller liquid temperature adjust
  - iii. Remote current limit set point adjust
  - iv. Remote ready to start contacts
  - v. Safety shutdown contacts
  - vi. Cycling shutdown contacts
  - vii. Run contacts

## **9.0 COMPRESSOR MOTOR STARTER**

**9.1.1** Star Delta Closed starter with NEMA 1 enclosure suitable for pad mounting. A 14-gauge (minimum) steel terminal box with gasketed front access cover will be provided for field connected conduit. The chiller graphic control panel shall provide Overload/over current protection. Jumpers shall be furnished for three lead types of starting. Motor terminal lugs shall be not furnished.

## **10.0 MISCELLANEOUS ITEMS**

10.1.1 Ant vibration mounts, steel & spring loaded with serrated rubber pads for field mounting under unit feet for vibration isolation shall be supplied by the contractor.

10.1.2 The Screw liquid Chillers shall be complete with Compressors, Air Cooled Condensers, Shell & Tube or DX type Evaporators (Chillers), electrical control panel with starters, interconnecting cabling etc. The machine shall be capable of delivering 75 TR (Actual Capacity for **City of Pune** ambient condition) for the following conditions chilled water outlet temperature - 07 Deg.C, chilled water inlet temperature - 12 Deg.C, Ambient Temperature – For the City Of Pune. The Chiller shall be capable of Operation on 415 V, 50 Hz, 3 Phase, complete with electrical Panel, having a microprocessor control, having following features, Single Phasing Prevention, Under & Over Voltage Protection, Phase Reversal Protection, Independent Set Points for each refrigeration Circuit, HP/LP Trip signal indication & interlocking, Condenser Fan Motor Over Load Protection, Interlocking for chilled water flow switch, Runtime equalization for multiple compressors. (The equipment shall have high efficiency lowest IKW / TR). The chillers shall have stepless capacity control 10% to 100% (Vanes / slide valve). The Chiller shall be complete with Lon Works / Bacnet protocol output card, to enable BMS integration.

## **11.0 INSTALLATION**

11.1.1 The installation of the machine shall be carried out with proper foundation and proper supporting. The contractor shall prepare all the necessary drawings with norms, design, specification given by consultants and shall be approved by the consultant before carrying out the installation work.

**END OF SECTION**

## CENTRIFUGAL PUMPS

### CONTENTS

1.0	GENERAL.....	37
1.1	Scope.....	37
1.2	Codes and Standards .....	37
1.3	Design Requirements .....	37
2.0	FEATURES OF CONSTRUCTION.....	37
2.1	Casing .....	37
2.2	Impellers.....	37
2.3	Wearing Rings.....	38
2.4	Shaft .....	38
2.5	Shaft Seal .....	38
2.6	Bearings .....	38
2.7	Coupling.....	38
2.8	Alignment.....	39
3.0	TESTS AND INSPECTION .....	39
4.0	PERFORMANCE TEST.....	39
4.1	Standard Running Test.....	39
4.2	NPSH Tests .....	39
4.3	Mechanical Balancing.....	39
4.4	Field Testing .....	39
5.0	TENDER DRAWINGS .....	40
6.0	PAINTING.....	40
7.0	PUMP HEAD CALCULATION .....	40
8.0	DATA SHEETS .....	41
8.1	Data Sheet-A .....	41
8.2	Data Sheet-B .....	43
8.3	Data Sheet-C .....	44
8.4	Data Sheet-D .....	45

## **12.0 GENERAL**

### **12.1 Scope**

12.1.1 This specification covers the supply, installation, testing & commissioning of Horizontal Centrifugal Pumps of Mono block type.

### **12.2 Codes and Standards**

12.2.1 The design, materials, construction, manufacture, inspection and performance testing of horizontal centrifugal pumps shall comply with all currently applicable statutes, regulations and safety codes in the locality where the equipment is to be installed. Nothing in this specification shall be construed to relieve the CONTRACTOR of this responsibility. The equipment supplied shall comply with the latest applicable Indian, American, British or equivalent standards.

### **12.3 Design Requirements**

12.3.1 The total head capacity curve shall preferably be continuously rising towards the shut off. In case of unstable (drooping) characteristic the duty point shall be well away from the unstable region. The shut off head shall be at least 110% of the total head.

12.3.2 The required NPSH at duty point shall be at least 1.0 M less than the available NPSH.

12.3.3 Pumps shall run smooth without undue noise and vibration. The noise level shall be limited to 75 dBA at a distance of 1.8 M. Vibration shall limited to class IIC of BS 4675 Part –I. The power rating of the pump motor shall be the larger of the following:

- i. The maximum power required by the pump from zero discharge to zero head.
- ii. 110% of the power required at the duty point.

12.3.4 Pumps of a particular category shall be identical and shall be suitable for parallel operation with equal load division. Components of identical pumps shall be interchangeable.

## **13.0 FEATURES OF CONSTRUCTION**

### **13.1 Casing**

13.1.1 The casing shall be of heavy close grained cast iron, to withstand high tensile strength with smooth waterways and fitted with bronze wear ring. It shall be of vertically split design with streamlined volute and integral suction vertical position to facilitate piping. Casing shall have tapped openings for priming, vent. drain and gauge connections.

### **13.2 Impellers**

13.2.1 The impellers on end suction pumps shall be semi-open type carefully balanced for smooth operation. The impeller is hydraulically as well as dynamically balanced. Balancing openings shall be provided near hub of the impeller to reduce pressure on the stuffing box to approximately suction pressure. The impeller shall be secured to the shaft by feather and nut.

### **13.3 Wearing Rings**

- 13.3.1 Wearing rings are provided to maintain close running clearance and to minimize pressure leakage between suction and discharge chambers of the casing. The casing bearing rings shall protect the casing against wear and shall be locked in pump casing to prevent rotation.
- 13.3.2 Pump shall be provided with renewable type casing ring. Pump having capacity 2,000 cu.m/hr and above shall be provided with impeller ring in addition to casing ring. The hardness of impeller ring shall be 50 BHN higher than that of casing ring.

### **13.4 Shaft**

- 13.4.1 The shaft shall be of high strength steel with optimum diameter to provide maximum strength with minimum shaft deflection. Replaceable shaft sleeves shall be provided to protect the shaft where it passes through stuffing box.
- 13.4.2 Stuffing box shall be of such design that it can be repacked without removing any part other than the gland and lantern ring.

### **13.5 Shaft Seal**

- 13.5.1 The pump shall have mechanical shaft seals of extra hard carbon ceramic type

### **13.6 Bearings**

- 13.6.1 The bearings shall be precision ball bearings. The bearings shall be located and positioned on to shaft by means of lock nut.
- 13.6.2 The outdoor bearing shall be double row bearings, to take the radial and thrust loads. The inboard bearing shall be single row bearing taking the shaft radial load and shall be free to move axially in the bearing housing to compensate for shaft expansion due to temperature changes. Labyrinth deflectors shall be provided to exclude dirt and moisture from the bearing housing. Facilities shall be provided for grease lubrication. Grease reliefs shall be provided to prevent over-lubrication.
- 13.6.3 Bearing shall be grease lubricated and shall have a minimum life of 40,000 hours of working.

### **13.7 Coupling**

- 13.7.1 Pump shall be furnished complete with flexible coupling. Back-pull out pump shall be provided with spacer type coupling.
- 13.7.2 Coupling guard made of expanded metal and bolted to the base plate shall be furnished for all coupled pumps.
- 13.7.3 All accessories required for proper and safe operation shall be furnished with pumps.
- 13.7.4 All incidental piping (including valves) required for sealing, lubrication and cooling for stuffing box packing and / or bearing of pump shall be furnished by the Contractor.



### **13.8 Alignment**

- 13.8.1 The pump and motor shall be aligned by the pump manufacturer.
- 13.8.2 The pump manufacturer shall provide certification to the effect that the pump and motor coupling has been carried out by them and checked by them.
- 13.8.3 On completion of the installation, grouting and connection of all piping, the pump and motor shall be rechecked for alignment by means of accepted methods, by the pump manufacturer/sole agent.

### **14.0 TESTS AND INSPECTION**

- 14.1.1 A standard hydrostatic test shall be conducted on the pump casing with water at 1.5 times the maximum discharge head or twice the rated discharge head., whichever is higher. While arriving at the above pressure, the maximum suction head shall be taken into account.
- 14.1.2 The hydrostatic tests on the casing shall be conducted for a minimum duration of 30 minutes.

### **15.0 PERFORMANCE TEST**

#### **15.1 Standard Running Test**

- 15.1.1 The pumps shall be tested as per IS 5120, at rated speed at SUB-CONTRACTOR's works to measure capacity, total head, efficiency and power. The negative tolerance on efficiency shall be limited to 2.5% (not 5 % as indicated in IS 5120. These tests shall form the basis for acceptance of pumps except for vibration and noise. The pumps shall be tested over the range covering from shut-off head to the maximum flow. The duration of the test shall be minimum one hour. Minimum five readings approximately equidistant shall be taken for plotting the performance curves.

#### **15.2 NPSH Tests**

- 15.2.1 NPSH tests shall be conducted with water as the medium.

#### **15.3 Mechanical Balancing**

- 15.3.1 In addition to static balancing, impeller and balancing drum shall be balanced dynamically at or near the operating speed.

#### **15.4 Field Testing**

- 15.4.1 After installation, the pumps shall be subjected to testing at site also. If the field performance is found not to meet the requirements regarding vibration and noise as specified, the equipment shall be rectified or replaced by the CONTRACTOR, at no extra cost to the CLIENT.

## **16.0 TENDER DRAWINGS**

16.1.1 The following drawings shall be submitted by the CONTRACTOR along with their Bids.

- i. Preliminary outline dimensional drawing of pump and motor (Suction and discharge connections and foundation details shall also be indicated).
- ii. Performance curves (capacity Vs total head, efficiency, NPSH and KW requirement) ranging from zero to maximum capacity.
- iii. Pump Catalogues.

## **17.0 PAINTING**

17.1.1 All ferrous surfaces shall be painted with one coat of red oxide primer paint followed by finish paint. However the components of the pumps shall not be painted before inspection.

## **18.0 PUMP HEAD CALCULATION**

18.1.1 It is very important that contractor shall submit actual pump head calculation based on site installation conditions taking into account pressure drop in installed (to be installed) chillers, piping and fitting. This actual pump head calculation shall be submitted for engineers approval before ordering equipment and motor. Required pump motor capacity will be provided based on actual head calculation without any extra cost.

## 19.0 DATA SHEETS

### 19.1 Data Sheet- A

#### Technical Requirements

1	DESIGN FEATURES	UNITS	
1.1	Pump designation		Chilled water pumps
1.2	Minimum design capacity	US GPM	
1.3	Total head	Ft	
14.	Location		Terrace Level
1.5	Maximum rated speed (at 50 Hz.)	RPM	
1.6	Liquid handled		Water
1.7	Number required		-- working Plus -- standby
<b>2.0</b>	<b>FEATURES OF CONSTRUCTION</b>		
2.1	Type of pump		Monoblock
2.2	Impeller		Open/Enclosed/Non clog
2.3	Volute		Single
2.4	Shaft		Coupled
2.5	Drive Transmission		Direct
2.6	Seal		Mechanical seal
2.7	Coupling		Flexible
2.9	Prime Mover		AC Electric motor
<b>3.0</b>	<b>MATERIALS OF CONSTRUCTION</b>		
3.1	Impeller		Bronze *
3.2	Casing		Cast Iron GR FG 200*
3.3	Shaft		EN – 8 Steel *
3.4	Shaft Sleeve		EN-8 Steel *
3.5	Impeller Ring		SS 304 *
3.6	Casing Ring		Cast Iron GR FG 200*
3.7	Stuffing Box Packing		Graphite-Asbestos*
3.8	Base Plate		Fabricated Steel / Cast Iron*

<b>4.0</b>	<b>ACCESSORIES</b>		
4.1	Companion Flanges		Yes
4.2	Foundation Bolts		Yes
4.3	Base Plate		Yes
<b>5.0</b>	<b>TESTING</b>		
5.1	Hydrostatic Test Casing Jackets / Cooling Passage		Witnessed
5.2	Performance Test Std. Running Test NPSH Test		Witnessed

Note : For components marked \* material test certificates shall be furnished

## 19.2 Data Sheet- B Data

To Be Furnished By Tenderer Along With Offer (Chilled Water)

SL. NO.	DESCRIPTION	TENDERER TO FURNISH
1	Pump tag number	
2	Number working stand by	
3	Make	
4	Model	
5	Design Capacity	Cu.m/hr
6	Differential Head	MLC
7	Shut off head	MLC
8	Hydrostatic test pressure	Kg / cm <sup>2</sup> (g)
9	Pump efficiency	%
10	Motor efficiency at duty point	%
11	Power input to motor at duty point	KW
11.1	Motor rating –BKW / KW	KW
12	Rated speed	Rpm
13	NPSH required	MLC
14	Materials of construction as per specification indicate deviations	
15	Suction Nozzle	
15.1	Orientation	
15.2	Size	Mm
16	Discharge Nozzle	
17	Impeller type	
18	Pump weight	Kg
19	Pump set weight	Kg
20	Moment of inertia of pump rotor	Kg – m <sup>2</sup>

### **19.3 Data Sheet – C Data**

#### **To Be Furnished By The Contractor After Award Of Contract And `Before` Installation**

- i. Quality Assurance Plan (QAP)
- ii. Detailed dimensioned general arrangement drawing of pump and driver.
- iii. Foundation drawing of pump and driver with static and dynamic loads, details of fixing, grouting and all relevant data required for design of foundation
- iv. Cross-section drawing of the pump with complete part list, materials of construction and relevant standards for each part
- v. Pump performance curves flow rate Vs head, BKW, efficiency, NPSHR from zero flow to maximum flow and torque-speed curve
- vi. Scheme for pump sealing, lubrication and cooling
- vii. Driver dimensional drawing
- viii. Surface preparation and painting procedures
- ix. Catalogues, data sheets and drawings for instruments
- x. Installation, operation and maintenance manual
- xi. Isolation pads and SS or Hot dip galvanised foundation bolts provided by the Contractor.
- xii. Corc-rubber make metallic bellows shall be provided at suction and discharge.
- xiii. Pressure gauges with needle valve provided at suction and discharge lines.
- xiv. All accessories provided to complete the pump installation.

**19.4 Data Sheet – D**

**Checklist And Performance Test Data To Be Provided After Installation**

Sr. No	Description	Unit	Time			Date			Remarks
			10.00	12.00	14.00	16.00	18.00	20.00	
1.	Suction pressure	Kg/cm <sup>2</sup>							
2.	Discharge pressure	Kg/cm <sup>2</sup>							
3.	Water flow rate	M <sup>3</sup> /hr							
4.	Current	Amps							
5.	Bed plate levels and alignment checks								
6.	Hydraulic test for casing at 1.5 times design pressure								
7.	Noise level from pump	1.8m dB							
8.	Discharge Vs head	Mtr							
9.	Discharge Vs efficiency								
10.	Discharge Vs BkW								

19.4.1 Run Test shall be conducted on the following Pumps.

- i. Chilled Water pumps.
- ii. Make up Water pumps.

**END OF SECTION**

## AIR HANDLING UNITS

### CONTENTS

1.0	GENERAL .....	47
1.1	Introduction .....	47
1.2	Codes and Standards .....	47
2.0	CONSTRUCTION FEATURES.....	47
2.1	Type .....	47
2.2	Casing .....	47
2.3	Cooling Coils .....	48
2.4	Fan.....	48
2.5	Drain Pan.....	49
2.6	Filter Section.....	49
2.7	Mixing Box (Wherever Applicable) .....	50
2.8	Dampers .....	50
3.0	AHU PRESSURE CALCULATION .....	50
4.0	NOISE LEVEL .....	50
5.0	TECHNICAL REQUIREMENTS .....	50
6.0	DATA SHEET-A.....	52
7.0	DATA SHEET-B .....	54
8.0	DATA SHEET – C .....	55
9.0	DATA SHEET – D .....	56
10.0	MODE OF MEASUREMENT .....	59
10.1	Air handling unit .....	59
10.2	Supply air fan unit.....	59
10.3	Exhaust air fan unit.....	59
10.4	Pre-filters.....	59



## **20.0 GENERAL**

### **20.1 Introduction**

20.1.1 This specification covers the general design, materials, and construction features, manufacture shop inspection and testing at manufacturer's works, delivery at site, handling at site, installation, testing, commissioning and carrying out performance test at site of Air Handling Units (AHUs).

### **20.2 Codes and Standards**

20.2.1 The design, materials, manufacture, inspection, testing and performance of AHUs shall comply with all currently applicable statutes, regulations, codes and standards in the locality where the equipment is to be installed. Nothing in this specification shall be construed to relieve the ACMV Contractor of this responsibility. In particular, the AHUs shall conform to the latest edition of following standards

IS 7613	Methods of Testing Panel type Air Filters for Air Conditioning and Ventilation purposes.
ASHRAE 33	Methods of Testing – Forced Circulation Air Cooling and Air Heating Coils.
ARI 410	Forced circulation Air-Cooling and Air-Heating Coils.
ARI 430	Central-Station Air-Handling Units.
AMCA 210	Laboratory methods of Testing Fans for rating
FED STD 209E	Clean room and Work Station requirements, controlled environment.
NFPA 90A	Installation of Air-conditioning and ventilating systems.

## **21.0 CONSTRUCTION FEATURES**

### **21.1 Type**

21.1.1 The AHUs shall be draw through type (Floor mounted, Ceiling Suspended Type as specified in Bill of qty). The unit shall comprise of various sections such as Pre-filters, mixing plenums, fine filters, cooling coil, Drip Eliminator, fan, etc.

### **21.2 Casing**

Casing shall be of Double skin construction.

- 21.2.1 Double Skin wall panels shall be 46+/-2 mm thick made of GSS, pressure injected with polyurethane foam insulation of density 38 kg/cum and K factor not exceeding 0.02 W / M2 ° C. Double skin wall panels shall be fixed to 2.5 mm thick aluminium alloy twin box section structural framework with stainless steel screws. Outer sheet of the panels shall be made of 0.8 mm thick GSS pre-plasticised or powder coated. Inner sheet shall be 0.8mm thick plain GSS.
- 21.2.2 The entire framework shall be mounted on a 100mm (minimum) aluminium alloy channel base. The panels shall be sealed to the framework by heavy-duty “O” ring neoprene gaskets held captive in the framed extrusion. All panels shall be detachable or hinged. Hinges shall be made of die cast aluminium with stainless steel pivots. Handles shall be made of hard nylon and be operational from both inside and outside of the unit. Units supplied with various sections shall be suitable for on-site assembly match drilled, with bolts, nuts and continuous neoprene rubber gaskets. All fixing and gaskets shall be concealed.
- 21.2.3 Floor and roof panels shall be Double skin type and shall be of same construction as the wall panels. AHUs shall have hinged quick-opening insulated access door on fan and filter sections. Access doors shall be double skin type and shall be of same construction as the wall panels.
- 21.2.4 Four (4) lifting lugs shall be bolted to each base section for lifting or placing the AHU in place. All connecting fasteners and related hardware and its accessories shall be in stainless steel.
- 21.2.5 Sloping condensate drain pan shall be fabricated from 0.8mm (22g) stainless steel sheet and stainless steel nipple for drain connection. It shall be isolated from bottom floor panel through 25mm thick heavy duty Treated for Fire (TF) quality expanded polystyrene or polyurethane foam. Drain pan shall extend beyond the coil.
- 21.2.6 Casing shall be of air-tight construction and sufficiently rigid to exclude vibrations, throughout the working capacity range of the AHU.

### **21.3 Cooling Coils**

- 21.3.1 The coil section of the AHU shall be of the cartridge-type, removable from the side of the casing and supported over the entire length of the coil. Chilled water coil shall be plate fin type with aluminium ripple corrugated fins and staggered cleanable tubes with not more than 5 Fins per centimetres. Fins shall have collars, belled and firmly bonded to the tubes by having the tubes mechanically expanded into the fins.
- 21.3.2 Coil face velocity shall not exceed as specified on the coil schedule. The number of fins provided should be the minimum needed to meet the performance requirements to minimize the pressure drop across the coil. Coil casing shall be 1.5mm thick galvanized, steel with drain holes in the bottom channels to insure condensate drainage. Coil tubes shall be copper mechanically expanded into aluminum plate fins. No soldering or tinning shall be used in the bonding process. Coils shall be mounted in the unit casing on non- corrosive aluminum slide rails to allow for easy removal when required. Coils shall be designed to utilize the full available unit cross section area.
- 21.3.3 Coils shall have automatic air vents, the vent outlets beings piped to the drain pan with a copper pipe. Each coil shall be proof tested at 26 bar (375 psig) leak tested at 17 bar (250 psig)

### **21.4 Fan**

- 21.4.1 The fan section of the air handling unit shall be of rigid constructions, with the fan scroll and bearings mounted on a frame rigidly secured to a formed channel base. Fans shall be of the double – width, double – inlet centrifugal type with forward curved airfoil blades. Bearings shall be self-aligning, pillow-block type selected for an average life of 200,000 hours at design operating conditions, and shall be provided with grease line extending to the outside of the AHU casing.

21.4.2 The fan wheels shall be keyed to the shaft and the complete wheel and shaft assembly shall be statically and dynamically balanced. Fan and shaft assembly shall be selected to operate at a speed of at least 25% below the first critical speed. Fan shall be designed for continuous operation at the maximum rated speed and capacity. Outlet velocity shall not exceed ASHRAE recommendations. Fan shall be driven by or internally unit-mounted motor connected to fan by V-belt drive. Access panel for easy belt change shall be provided for internally mounted motors. Belt connected motor capacity and shall adjustable to provide not less than  $\pm 20\%$  speed variation. Motors shall be provided with adjustable bases for belt tensioning. The entire AHU fan -motor assembly shall be housed inside the AHU casing and mounted on a epoxy coated common steel base channel section with vibration isolation mounting. If the Fan capacity exceeds 6,000 CFM, it should be provided with spring isolators.

21.4.3 Fan motor shall be of totally enclosed fan-cooled type and shall be suitable for 415V / 3 Ph / 50 Hz. Motor shall be sized to provide the additional power requirements when the fan is operated to provide an additional 20% of the rated capacity.

21.4.4 Supply fan performance shall be rated in accordance with ARI standard 430.

## **21.5 Drain Pan**

21.5.1 An insulated condensate drain pan shall be provided in each AHU which shall extend under the entire coil and fan section. The drain pan shall be of double-wall construction with 25 mm thick foam insulation cemented between the hot-dipped galvanised steel outer pan and inner pan. The inner pan shall be finished with a coating of water – proof and corrosion – resistant material. Drain connection shall be provided on both sides of the casing. The drain pan shall be sloped  $\frac{1}{4}$  inch per ft and constructed to allow complete pan drainage.

21.5.2 Heavy duct flexible double layer canvas connection shall be provided at the outlet of AHU fan. Additional double layer canvas connection shall be provided between the GSS ducting and AHU. This canvas connection shall contain a provision (zip) for measuring the DBT and WBT of the cooled and dehumidified air.

21.5.3 The AHU shall be provided with the following accessories, bulk head lamp, inspection windows, limit switch, extended grease lines and belt and motor guard.

## **21.6 Filter Section**

### **21.6.1 Pre-Filter**

Each unit shall be provided with a factory assembled filter section containing 48mm thick washable synthetic type air filters having GSS frame. The media shall be supported with High Density polyethylene (HDPE) mesh on one side and aluminium on the other side. Filter banks shall be easily accessible and designed for easy withdrawal and replacement of filter cells. Filter bank framework shall be fully sealed and constructed from GSS. The efficiency of the filters shall be 90%down to particle size of 20 microns as per IS 7613, and ASHRAE 52.1.

### **21.6.2 Filters - Codes and Standards.**

- |    |                 |  |
|----|-----------------|--|
| a. | ASHRAE 52.1     | Gravimetric and Dust spot procedures for testing Air cleaning devices. |
| b. | IS 7613         | Methods of testing panel type Air filters for HVAC                     |
| c. | FED – STD – 209 | Clean room and work station requirements.                              |

### 21.7 Mixing Box (Wherever Applicable)

Mixing box shall be complete with fresh and return air dampers. Mixing box shall be provided whenever the return air is ducted back to the AHU.

### 21.8 Dampers

Dampers shall be opposed blade type. Blades shall be made of double skin airfoil extruded aluminium sections with integral gasket and assembled within a rigid extruded aluminium or nylon, turning in Teflon bushes. In case of automatic dampers, sealed ball bearings shall be provided, in place of Teflon bushes. Manual dampers shall be provided with a bakelite knob for locking the damper blades in position. Linkages shall be extended for motorised operation if specified in data sheet A. Damper frames shall be sectionalised to minimise blade warping. Air leakage through dampers when in the closed position shall not exceed 1.5% of the maximum design air volume flow rate at the maximum design air total pressure.

### 22.0 AHU PRESSURE CALCULATION

Contractor shall submit calculations for the internal and external pressure of each AHU system based on the equipment to be selected and ducting system to be installed including pressure drops in coil, filter, ducts and fittings, VD,FD, Diffusers etc. Contractor shall obtain approval from consultant on the SP Calculations before ordering AHU motor. Required motor HP based on actual Calculated SP shall be provided without extra cost.

### 23.0 NOISE LEVEL

The noise level inside the AHU room should be less than 65 dBA.

### 24.0 TECHNICAL REQUIREMENTS

Sr. No.	Description	Requirements
1	Numbers and minimum capacity	Refer equipment schedule
2	Cooled and Dehumidified air flow rate –	Refer schedule
3	Cooling coil face area	Air velocity across cooling coil face area to be less than 2.5 m/s (500 FPM)
4	Number of rows for cooling coil	4 ~ 6
5	Entering chilled water temperature – deg C	7 deg C
6	Leaving chilled water temperature – deg C	12 deg C
7	Chilled water flow rate – m <sup>3</sup> /hr	Refer schedule
8	Drain connection on both sides of	25 mm dia socket connection

	AHU	
9	Coil tube dia	12.5 mm
10	No. of Fins	Not more than 13 FPI
11	Type of fan motor	415 V, 3 PH, 50 Hz TEFC Sq. Cage energy efficient EFF 1
12	Type of starter	Star-Delta / DOL
13	Pre-Filters (cleanable type)	Pre filters (panel type) of 90% efficiency down to 20 microns Class EU3 as per BS EN 779. Maximum face velocity 1.75 m/s

**25.0 DATA SHEET-A**

<b>Sr. No.</b>	<b>Description</b>	<b>Requirements</b>
1.	Air Handling Unit No.	
2.	Type	Ceiling / Floor Horizontal / Floor Vertical
3.	Model / Make	
4.	Grand Total Heat (TR)	
5.	Total Sensible Heat (TR)	
6.	Minimum Supply Air Quantity (S/A – CMH)	
7.	Minimum Outside Air Quantity (O/A – CMH)	
8.	Air entering coil temperature (TE-DB deg C)	
9.	Air entering coil temperature (TE – WB deg C)	
10.	Air leaving coil temperature (TL – DB deg C)	
11.	Air leaving coil temperature (TL – WB deg C)	
12.	Maximum Air Face Velocity (m/sec) across coil	2.5
13.	Maximum Air side pressure drop across coil (Pascals)	
14.	Total Fan Static Pressure (Pascals)	
15.	External Static Pressure (Pascals)	
16.	Chilled Water Entering Coil Temperature (deg C)	
17.	Chilled Water Leaving Coil Temperature (deg C)	
18.	Chilled Water Velocity – Maximum (m/sec)	
19.	Coil Rows	
20.	Coil Fins / Cm.	
21.	Chilled Water Flow Rate m <sup>3</sup> / hr	
22.	Maximum Chilled Water Pressure Drop (m) through coil	
22.1	Type of Fan	FC / BI / Aerofoil
22.2	Type of Fan Control	Variable Air Volume / Constant Air Volume.
22.3	Maximum fan rpm	
22.4	Maximum outlet velocity	M / sec

<b>Sr. No.</b>	<b>Description</b>	<b>Requirements</b>
23.	Type of Filters	
24.	Prefilters Numbers Dimension Efficiency Face velocity	
25.	Type of Starter	
26.	Motor Voltage	
27.	Type of Vibration isolator	
28.	Interlock with smoke detector and fire alarm system	
29.	Supply and return air noise treatment	
30.	Controls	
31.	Dimensions L x B x H	
32.	Operating weight kg	
33.	AHU motor kW rating	BKW / KW

## **26.0 DATA SHEET-B**

- 26.1.1 Schedule of drawings and documents to be submitted for review, approval and information with submission dates.
- 26.1.2 Quality Assurance Plan (QAP).
- 26.1.3 Detailed P & I diagram showing clearly the scope of supply of equipment, piping with line sizes and material specifications, valves, specialities, instrumentation and control and all accessories. This drawing or documents mentioned under following clauses shall include all design data and information furnished in data sheets A and B. The makes of all major components and controls shall be indicated.
- 26.1.4 Dimensioned general arrangement drawing showing all equipment with accessories, mounting details, nozzle locations, etc.
- 26.1.5 Overall space and head room requirement with details of handling during erection, operation and maintenance.
- 26.1.6 Foundation drawing with static and dynamic loading data, pocket details, foundation outline, etc, for all items.
- 26.1.7 Cross-sectional drawings of all items with part list and materials of construction.
- 26.1.8 Performance curves and selection charts for fan, filters, etc. Selection charts and calculation for cooling coil and heating coil.
- 26.1.9 Operation and maintenance manual with lubrication schedule.
- 26.1.10 Catalogues furnishing detailed technical data for fan, coils, filters, etc.



**27.0 DATA SHEET – C**

<b>Sr. No.</b>	<b>Description</b>	<b>Units</b>	<b>Remarks</b>
1.	Entering Air temp DB (deg C)		
2.	Entering Air temp WB (deg C)		
3.	Leaving Air temp DB (deg C)		
4.	Leaving Air temp WB (deg C)		
5.	Entering Water temp (deg C)		
6.	Leaving Water temp (deg C)		
7.	Coil / Filter area (SFT)		
8.	Face Velocity (FPM)		
9.	Air Flow (CFM)		
10.	Fan Speed (RPM)		
11.	Voltage		
12.	Current (A) = R- Phase		
	= Y- Phase		
	= B- Phase		
13.	Over load relay range A		
14.	Over load relay setting A		
15.	Inlet Water pressure (Kg / cm <sup>2</sup> )		
16.	Outlet water pressure (Kg / cm <sup>2</sup> )		
17.	Noise level AHU room (dBA)		
18.	Vibration level = X - axis (Microns)		
	= Y - axis		
	= Z - axis		
19.	Fresh air velocity (FPM)		
20.	Fresh air filter area (SFT)		
21.	Fresh air flow (CFM)		
22.	Designed CFM		

**28.0 DATA SHEET – D**

Sl. No.	Description	OK	Needs Attention	Not Applicable	Remarks
<b>Outside Air Intake</b>					
1.	Location				
2.	Open during occupied hours				
3.	Unobstructed				
4.	Odors from outdoors (describe)				
5.	Cooling tower within 25 feet				
6.	Exhaust outlet within 25 feet				
<b>Brid Screen</b>					
7.	Unobstructed				
8.	General condition				
<b>Outside Air Dampers</b>					
9.	Operation acceptable				
10.	Seal when closed				
11.	Actuators operational				
12.	Minimum % O.A				
13.	Measured % O.A <i>Note day, time, HVAC operating mode under "Comments"</i>				
14.	Maximum % O.A				
15.	Is minimum O.A. a separate damper				
16.	For VAV systems: is O.A. increased as total system air-flow is reduced				
<b>Mixing Plenum</b>					
17.	Clean				
18.	Floor drain trapped				
19.	Air tightness				
20.	√ of outside air dampers				
21.	√ of return air dampers				

Sl. No.	Description	OK	Needs Attention	Not Applicable	Remarks
22.	✓ of exhaust air dampers				
23.	All damper motors connected				
24.	All damper motors operational				
25.	Air mixers or opposed blades				
26.	Mixed air temperature control setting ----- °F				
27.	Is mixing plenum under negative pressure <i>Note: If it is under positive pressure, outdoor air may not be entering.</i>				
<b>Filters</b>					
28.	Type				
29.	Complete coverage (i.e., no bypassing)				
30.	Correct pressure drop (Compare to manufacturer's recommendations.)				
31.	Contaminants visible				
32.	Odor noticeable				
<b>Cooling Coil</b>					
33.	Inspection access				
34.	Clean				
35.	Supply water temp.----- °F				
36.	Water carryover				
37.	Any indication of condensation problems				
<b>Condensate Drip Pans</b>					
38.	Accessible to inspect and clean				
39.	Clean, no residue				
40.	No standing water, no leaks				
41.	Noticeable odor				
42.	Visible growth (e.g., slime)				
43.	Drains and traps clear, working				
44.	Trapped to air gap				

Sl. No.	Description	OK	Needs Attention	Not Applicable	Remarks
45.	Water overflow				
<b>Supply Fan Chambers</b>					
46.	Clean				
47.	No trash or storage				
48.	Floor drain traps are wet or sealed				
49.	No air leaks				
50.	Doors close tightly				
<b>Supply Fans</b>					
51.	Location				
52.	Fan blades clean				
53.	Belt guards installed				
54.	Proper belt tension				
55.	Excess vibration				
56.	Corrosion problems				
57.	Controls operational, calibrated				
58.	Control sequence conforms to design / specifications (describe changes)				
59.	No pneumatic leaks				
<b>Steam Humidifier</b>					
60.	Humidifier type				
61.	Treated boiler water				
62.	Standing water				
63.	Visible growth				
64.	Mineral deposits				
65.	Control setpoint ----- °F				
66.	High limit setpoint ----- °F				
67.	Duct liner within 12 feet (If so, check for dirt, mold growth.)				

## **29.0 MODE OF MEASUREMENT**

Representatives from the Contractor and Engineer shall conduct a joint inspection of the Equipments. All the discrepancies observed either incomplete works or defective work shall be clearly indicated in the joint inspection report. The mode of measurements given below is for the purpose of measurement and payment and the scope of works shall be as specified else where in the specification.

### **29.1 Air handling unit**

Air handling unit of cabinet type along with flexible connection at fan outlet, flexible connection at chilled water pipe inlet and outlet of AHU, filter, fan, motor, outlet damper etc., as specified in tender document shall form one unit for the purpose of measurement and payment.

### **29.2 Supply air fan unit**

Supply air fan unit consisting of fan, fan motor, louvers, filters, vibration isolators, sound attenuators, outlet dampers, flexible connection at fan outlet, weather proof enclosure of GSS cabinet type construction and accessories will be regarded as one unit for the purpose of measurement and payment. This is applicable for measurement and payment of Fresh air supply units, kitchen supply air unit and lift lobby supply air units.

### **29.3 Exhaust air fan unit**

Exhaust air fan unit consisting of fan, fan motor, louvers, vibration isolators, outlet dampers, flexible connection at fan inlet, weather proof enclosure of GSS cabinet type construction and accessories will be regarded as one unit for the purpose of measurement and payment. This is applicable for measurement and payment of toilet exhaust air units, kitchen exhaust air unit, and electrical panel room exhaust air unit.

### **29.4 Pre-filters**

Pre-filters and fine filters complete with support, frame etc., shall be measured from the approved drawings I as built drawing on the basis of core area (excluding margin flanges) and paid per unit area. Pre filters and final filters in supply air fan units are part of fan units and no separate payment will be made for the same.

**END OF SECTION**

**4 WAY CASSETTE TYPE UNITS**

**CONTENTS**

1.0	GENERAL.....	61
1.1	Type .....	61
1.2	Mounting.....	61
1.3	Coils .....	61
1.4	Drain Pan.....	61
1.5	Motors and Fan .....	61
1.6	Fan speed control / Room thermostat assembly.....	61
1.7	Temperature control.....	61
1.8	Filter section.....	61
1.9	Noise Level .....	62
2.0	MODE OF MEASUREMENT .....	62

## **30.0 GENERAL**

### **30.1 Type**

30.1.1 The 4 way cassette type unit shall be of the factory assembled and of integral fan type with chilled water cooling coil and shall be made for ceiling mounted type. The decorative grill and the Panel shall be made with ABS and the Inner coil Holding body Cabinets shall be fabricated out of 0.8 mm gauge G.S.Sheet. 4 way cassette Unit shall be complete with necessary valve station.

### **30.2 Mounting**

30.2.1 The concealed 4 Way cassette type coil unit shall be securely attached to the slab with threaded rod and shall be set dead level in both directions.

### **30.3 Coils**

30.3.1 Coil shall be constructed of aluminium fins mechanically bonded to copper tubes. The minimum fin thickness shall Not be less than 0.0055” and tubes dia shall be not less than 7.00 mm O.D. and the minimum wall thickness of the tube shall not be less than be 0.3 mm. Coil shall be tested at 17 bar while submerged in water. The coil shall be factory assembled and tested for intensity test pressure and the test certificate shall be submitted.

### **30.4 Drain Pan**

30.4.1 Drain Pan shall be provided under the cooling coil, supply and return lines. The pan shall be of sufficient size to catch all drippage of condensation from any part of the unit. The drain pan for Cassette unit shall be seld insulating EPS or as per the manufacturer supply as a standard part and shall be insulated with not less than 12 mm thick thermal EPS / polyurethane sheet to effectively prevent condensation from the pan. The drain pan for valve station is also to be shall be of sufficient size to catch all drippage of condensation from any part of the unit. With insulation to effectively prevent condensation from the pan

### **30.5 Motors and Fan**

30.5.1 Motor shall be of the split capacitor type and shall have sufficient torque to start on low speed. The motor shall suitable for the current characteristics set out. The motor shall be PSC type motor and have built-in thermal over load protection. Fans shall be of Screw Fan with Forward curve mounted on a vertical axis type direct driven by motor. Motor shall be suitable for 220 - 240V/1Ph/50Hz Power supply.

### **30.6 Fan speed control / Room thermostat assembly.**

30.6.1 The unit shall be complete with remote fan speed control switch (either high – medium – low - off). The room thermostat / 3speed switch will be mounted on a single decorative plate on the location approved by the Engineer.

### **30.7 Temperature control**

30.7.1 The unit shall have temperature control by way of a 3 way modulating valve operated by a thermostat.

### **30.8 Filter section**

30.8.1 Pre-filters (70 % efficiency down to 20 microns), 2 ~ 2.5 mm thick.

30.8.2 Fan Coil Units shall be 4 way cassette type with decorative panel, Drain pump, drain Pan, Fan and wireless remote control.

**30.9 Noise Level**

30.9.1 The Noise Level of the Fan Coil Unit must be within acceptable limits. The Contractor shall note that, if in the opinion of Consultant Engineer the noise level is unacceptable, Contractor has to carryout necessary remedies / alterations as are deemed necessary to reduce noise level to acceptable limits. The noise level based on the capacity of the units shall be within 45 dbA ~ 54 dbA at 1 mtr level from the unit.

**31.0 MODE OF MEASUREMENT**

31.1.1 Representatives from the Contractor and Clients Engineer/Consultants Engineer shall conduct a joint inspection of the Equipments. All the discrepancies observed either incomplete works or defective work shall be clearly indicated in the joint inspection report. The mode of measurements given below is for the purpose of measurement and payment and the scope of works shall be as specified else where in the specification.

**END OF SECTION**



## WATER DISTRIBUTION SYSTEM

### CONTENTS

1.0	GENERAL.....	64
1.1	Scope.....	64
1.2	Codes and standards.....	64
1.3	Scope of supply and erection .....	64
2.0	MATERIAL SPECIFICATION.....	65
3.0	FABRICATION.....	66
4.0	CLEANING OF PIPING .....	66
5.0	PROTECTION DURING TRANSIT .....	66
6.0	SHOP AND FIELD HYDROSTATIC TESTS.....	66
7.0	WATER TREATMENT .....	66
8.0	GUARANTEE .....	67
9.0	WATER PIPING.....	67
10.0	PRESSURE GAUGES & THERMOMETERS .....	67
11.0	EXPANSION TANKS.....	67
12.0	TESTING .....	68
13.0	VALVES.....	69
13.1	Gate and globe valves .....	69
13.2	Butterfly valves .....	69
13.3	BALL VALVES .....	69
13.4	CHECK VALVES .....	69
13.5	STRAINERS .....	69
13.6	Auto Balancing Valves .....	69
14.0	MODE OF MEASUREMENT: .....	71
14.2	Piping and Pipe insulation.....	72
14.3	Valves .....	72
14.4	Strainers .....	72
14.5	Expansion tank.....	72

## **32.0 GENERAL**

### **32.1 Scope**

32.1.1 This section lays down the general requirements for Supply, Installation and testing of all Piping works like Chilled Water, Condenser water, Condensate drain piping and Refrigerant piping and related valves and accessories.

### **32.2 Codes and standards**

32.2.1 The material construction, manufacture, inspection, testing and commissioning of water distribution piping shall comply with all currently applicable statutes, regulations and safety codes in the locality where the Equipment will be installed. Nothing in these specifications shall construe to relieve the CONTRACTOR of his responsibility. The equipment supplied shall comply with the latest applicable Indian and / or British Standards. Other National Standards are acceptable, if they are established to be equal or superior.

### **32.3 Scope of supply and erection**

32.3.1 The CONTRACTOR shall supply all piping material like pipes, fittings, flanges and other items as required.

32.3.2 Scope of erection to be performed by the CONTRACTOR is outlined below:

- a) The CONTRACTOR shall unload from carriers at plant site, handle, check, receive, transport, store, erect and test all materials furnished by him and others in accordance with this specification and General Conditions of Contract. The CLIENT shall be informed of any loss of damage within seven days of receipt of material.
- b) The CONTRACTOR shall also install small accessory piping and any specialities furnished for equipment such as relief valves, built-in bypass and other equipments of this type.
- c) CONTRACTOR's work includes the final tube or pipe connection at pumps, including the final connection.
- d) The CONTRACTOR shall install primary elements for flow measurements, control valves and on-line metering equipment.
- e) The CONTRACTOR shall hydrostatically test the entire piping system including valves and specialities.
- f) All piping shall be internally cleaned and flushed by the CONTRACTOR before and after erection in a manner suited to the service as directed by the CLIENT.
- g) For hydrostatic testing and water flushing, the CONTRACTOR shall furnish necessary pumps, equipment and instruments, piping etc
- h) The CONTRACTOR's scope under this includes the following:
  - i) Welding materials and other consumable materials and backing rings etc., as required.

- ii) Jointing material as required for all screwed joints. Fasteners (bolts, nuts, studs washers etc.) and gaskets is required for all flanged joints.
- iii) Services of erection superintendents, erection superiors, fitters, riggers, other skilled and unskilled labour.
- iv) Erection tools, tackles and materials including welding machines.

### **33.0 MATERIAL SPECIFICATION**

33.1.1 The material specification for piping, valves & specialities shall be as explained in later sections.

33.1.2 Colour code shall be used to identify pipe material. The CONTRACTOR shall be able to identify on request all random piping prior to any field fabrication.

33.1.3 The CONTRACTOR shall furnish six (6) copies of certificates for piping for –

- a) Dimensions and
- b) Hydrostatic test

### **34.0 FABRICATION**

- 34.1.1 The Chilled Water Piping shall be carried out using PPR plastic pipes with the Class PN-10 for the pipe sizes from 50mm TO 160mm and Class PN-16 for 20mm To 50mm. Pipe to pipe joining with the fusion welding and for any fitting with socket welding procedures. Pipe should be well supported as per manufacturer standard and site condition, approved by Consultant. The piping system should be tested for 2.5 time higher than its designed working pressure.
- 34.1.2 Wherever space permits, the CONTRACTOR may use pipe bends (3D) for pipe sizes 50 mm nominal size and under. The CONTRACTOR shall ensure that undue thinning of pipe wall does not occur due to bending.

### **35.0 CLEANING OF PIPING**

- 35.1.1 All piping shall be wire brushed and purged with air blast to remove all Dust and mill scale from inner surface. The method of cleaning shall be such that no material is left on the inner or outer surfaces, which will effect the serviceability of the pipe.

### **36.0 PROTECTION DURING TRANSIT**

- 36.1.1 Effective precautions such as capping and sealing shall be taken to protect all pipe ends against ingress of dirt and damage during transit or storage.

### **37.0 SHOP AND FIELD HYDROSTATIC TESTS**

- 37.1.1 All pipes and fittings shall be tested hydrostatically at the shops where manufactured to test pressures which are given in the applicable codes mentioned. All piping systems shall be tested hydrostatically by the CONTRACTOR after erection.
- 37.1.2 The chilled water and condensate drain piping shall be suitably insulated as per specification.
- 37.1.3 Automatic air vents shall be installed at all high sections of piping as well as in the AHU room piping.
- 37.1.4 The discharge from these air vents shall be piped via copper tubes of appropriate size to the nearest waste drain pipe.

### **38.0 WATER TREATMENT**

- 38.1.1 Contractor to Investigate the requirement for the quality of the water for the chiller and the available water quality at site and propose accordingly.
- 38.1.2 Chemical Dosing System (Sodium Hypochloride) shall be provided for chilled water network. The dosing system shall include all the necessary components / items inclusive of dosing pots, pumps and chemicals required. Contractor to arrange the chemicals required for next 12 months operation.
- 38.1.3 The air-conditioning system shall not be put into operation until the water treatment system is insulated and ready for use. The contractor shall be held responsible for any fouling or drainage due to the absence of water treatment.

### **39.0 GUARANTEE**

- 39.1.1 The CONTRACTOR shall guarantee all material, fabrication and workmanship, erection, installation and proper functioning of all the piping and also tightness of all joints, for a period of ten year from the date of commissioning.
- 39.1.2 The CONTRACTOR shall employ both in shop and field, qualified personnel and welders qualified recently to the satisfaction of the CLIENT.
- 39.1.3 If any shop fabrication part fails to meet the field tests in such a manner that the CLIENT's Inspection believes that the defect is minor, it will be remedied in the field by the CONTRACTOR at no cost to the CLIENT. In the event the CLIENT rejects defective part as not being capable of remedy in the field, the CONTRACTOR may at the CLIENT's discretion be required to transport new parts, from his shop at his own expense.

### **40.0 WATER PIPING**

- 40.1.1 All chilled water piping shall be of PPR type of PN 10 Class. All pipe joints shall be Join or provided with necessary fittings. Pipe flanges shall conform to IS:1536 whereas the threads shall conform to IS:554.
- 40.1.2 The screwed flanges shall also conform to IS:6392 and shall be screwed to the pipes. Gasket of 3 mm thick 3 ply rubber shall be used.

### **41.0 PRESSURE GUAGES & THERMOMETERS**

- 41.1.1 Bourdon type pressure gauges with aluminium casing with a minimum 100 mm dial and appropriate range complete with needle valves shall be provided at the inlet and outlets of heat exchangers, and pumpsets.
- 41.1.2 Thermometers shall be of dial type mounted on a board with separable copper well. The case shall be of cast aluminium, weather & water proof type. Thermo well shall be provided at the inlet and outlet of all heat exchangers.

### **42.0 EXPANSION TANKS**

Close expansion tank should be provided with water capacity to suffice the capacity of volume of water contraction & expansion during operation & rest state of the HVAC system. Tank should be a closed vessel with rubber bladder/diaphragm to maintain the operating pressure inside the pipelines. Standby and working booster pump should be provided with selector switch for pump starting, pressure differential transmitter , pressure gauge & non return valve at discharge outlet of the pump. Contractor to investigate the expansion tank size.

## **43.0 TESTING**

- 43.1.1 All piping shall be tested to hydrostatic test pressure of at least 1 ½ times the maximum operating pressure but not less than 7 Kg/Sqm for a period of not less than 24 hours. All leaks and defects in joints and piping during the test shall be rectified and got approved. No pipe shall be welded with water inside the pipes. Piping repaired subsequent to the above pressure shall be retested in the same manner. Systems may be tested in sections and such sections shall be capped securely. Entire system shall then be retested. Noiseless circulation of water in the circuit should be achieved. If improper circulation due to air lock is found, it is the responsibility of the air-
- 43.1.2 Air conditioning contractor to carry out all the rectification including opening and refinishing of floor, wall etc., Pressure gauges should be valve off during pressure testing. The air-conditioning contractor shall provide all materials, tools and instruments, services and labour required to perform the test and to remove the water resulting from cleaning and after testing. The water required for the testing shall be arranged by the contractor on his own cost. Additional claims for water testing shall not be entertained at any stage of the project.
- 43.1.3 The consultants shall be informed well in advance by the air-conditioning contractor of his intention to test a section or sections of piping and all such tests shall be witnessed by the consultants or their authorized representatives. Test certificates duly signed by the contractor and the consultant shall be submitted by the contractor after completing the tests.
- 43.1.4 No insulation shall be applied to pipes unless the pressure testing is completed to the satisfaction of the consultants. Insulation shall be done as per the tender specifications.
- 43.1.5 After completion of the installation, the pipe lines are to be flushed thoroughly to blow out the entire dirt and muck. Commissioning strainers shall be used before all equipments. The system then shall be balanced to deliver the water quantities as specified. Balancing report after certification shall be submitted with completion drawings and documents.
- 43.1.6 Direction of flow shall be marked on pipelines in bold markings.
- 43.1.7 Provide automatic air vents at highest points. The body shall be of cast iron and the float and leverage shall be of stainless steel. The operating pressure shall be 150 psig. Air vents, purge and drain valves are considered to be a part of the piping and no extra cost will be paid for the same.
- 43.1.8 Provide expansion joints to prevent bending, bowing of pipes resulting in unusual stresses. The expansion joint shall be complete with anchor bases, inner liners, tie rods, outer jackets and flanges. The expansion joints shall be of stainless steel.
- 43.1.9 Provide flanged rubber bellows at pump, chiller inlets and outlets that are assumed to be a part of the equipments.

## **44.0 VALVES**

### **44.1 Gate and globe valves**

44.1.1 Gate and globe valves up to 50 mm size shall be gun metal construction. Valves above 50 mm dia shall have cast iron body and bronze/gun metal spindle valve seat. The valves shall have non rising spindle.

### **44.2 Butterfly valves**

44.2.1 The butterfly valve shall be supplied along with flow control lever. The valves shall be compact in size and shall conform to BS 5155, MSS SP 67 and API 609. The valves shall be light in weight and easy to install. The body shall of close grain cast iron conforming to IS:210 and the seating shall be of Resilient black, Nitrile rubber / EPDM moulded on to the body. The disk shall be of SG iron nylon coated, whereas the shaft shall be of stainless steel A ISI 431 treated permanently for lubrication. The shaft seals shall be of Nitrile 'O' rings and rubber seals.

44.2.2 Valves shall be suitable for a working pressure of 16.5 KSC. Care should be taken during installation to see that the disk is not damaged during installation due to the flanges being incorrectly spaced. Provide gear operated valves for sizes having 300 mm and above. For smaller sizes such as 40 mm and below diaphragm type valves are acceptable.

### **44.3 BALL VALVES**

44.3.1 Ball Valves shall have body of carbon steel. The ball and the shaft shall be of stainless steel. The seat shall be of PTFE. The valve shall be complete with socket weld ends.

### **44.4 CHECK VALVES**

44.4.1 Check valves for smaller sizes shall be of swing type of gun metal construction. Lift type check valves shall be used for horizontal lines. Wafer type plate check valves shall be used for bigger sizes as shown in the specifications. The check valves shall be suitable for 10.5 KSC test pressure.

### **44.5 STRAINERS**

44.5.1 Strainers shall be preferably of approved 'Y' type or pot type as specified in the tender schedule with GI or fabricated steel bodies. Strainers up to 50 mm shall be of gun metal type. Strainers shall have a removable bronze screen with 3 mm perforations and permanent magnet. Strainers shall be provided with flanges. They shall be designed so as to enable blowing out accumulated dirt and facilitate removal and replacement of all screen without disconnection from the main pipe. Strainers shall be provided with isolating valves so that they may be cleaned without draining the entire system.

### **44.6 Auto Balancing Valves**

44.6.1 Balancing valve shall be installed in branch pipe and wherever shown on drawing. These valves shall be factory calibrated. Each valve shall limit flow rates to within  $\pm 5\%$  accuracy, regardless of system pressure fluctuations.

44.6.2 Sufficient number of flanges and unions shall be provided as required to facilities maintenance work once the piping is installed. Piping shall be properly supported on or suspended from stands, clamps, roller hangers, etc., as required. The contractor shall adequately design all brackets, saddles, clamps and hangers and shall be responsible for their structural integrity. Each support shall be isolated from the support by means of anti-vibration springs or durable liner of neoprene rubber. Pipe supports shall be of steel and shall be painted with rust preventive paint and finish coated with synthetic enamel paint of approved colour. Only factory made supports

with Galvanised fully threaded rods with bands are acceptable. The chilled water pipes shall be isolated from the bands by a rubber sheet. Pipe supports on the terrace exposed to weather shall be hot dip galvanized.

44.6.3 The spacing of pipe supports shall not be more than that as specified below:

NOMINAL PIPE SIZE IN MM	SPACING IN M
Upto 25 mm	1.5 m
32 to 150 mm	2.5 m
above 150 mm	3.0 m

44.6.4 The GI support rods shall be 8 mm thick for pipes upto 50 mm dia, 10 mm for pipes from 65 mm to 125 mm dia and 12 mm for pipes 150 mm dia and above.

44.6.5 Extra supports shall be provided at bends and heavy fittings like valves to avoid undue stresses on the pipes.

44.6.6 Suitably designed blocks shall used for resting the pipe on the supports wherever required.

44.6.7 Vertical risers shall be parallel to walls and column lines and shall be straight and plumb. Risers passing from floor to floor shall be supported at each floor by clamps or collars attached to pipe with a 12 mm thick rubber pad. Risers shall also have a suitable concrete pipe support at the lowest point.

44.6.8 Pipe sleeves of 50 mm larger diameter than the pipe shall be provided wherever pipes pass through the walls and the annular space filled with felt and finished with retaining rings. Insulated piping shall be supported in such a manner as not to put undue pressure on the insulation. 14 gauge sheet shall be provided between the insulation and clamps, saddle extending at least 10 mm on both sides of the clamps, saddles.

44.6.9 All welded bends shall be of 5 piece construction for pipe sizes 200 mm dia and for larger pipes at least 7 piece construction shall be provided.

44.6.10 Where pipes are laid underground, the top of the insulated pipes shall not be less than 750 mm from the ground. Pipes shall be placed over RCC / PCC sleepers as shown in the drawing. Buried pipes shall be covered by river sand cushion for a height not less than 150 mm from the top of the pipe. After pipes have been laid and top sand cushion provided, the trench shall be refilled with excavated soil and any extra soil shall be removed from the site of work by the contractor. RCC / PCC sleepers are in the scope of the air-conditioning contractor.

44.6.11 All piping work shall be carried out in a workman like manner causing minimum disturbance to the existing services. Piping installation shall be carried out with vibration elimination fittings wherever required. While installing the pipes, adequate clearance shall be provided for insulation wherever insulation is called for.

44.6.12 Drains shall be provided at all low points in the piping system and shall be of the following sizes:

MAIN LINE SIZE IN MM	DRAIN SIZE IN MM
Upto 300	25
Over 300	40

44.6.13 Drain shall be provided with gate valves of equal size but with rising spindle. Alternatively, ball valves shall be provided. Drain shall be piped through G.I medium class pipe to the nearest floor drain. Piping shall be pitched towards the drain points. Wherever specified, drain pipes for the ceiling suspended units and fan coil units shall be provided with water grade blue HDPE/PVC pipe with screwed joints. The joints shall be proper so that no water leaks over the false ceiling. The pipes shall be tested for leaks to a minimum pressure of 1 KSC before the false ceiling sheets are fixed.

44.6.14 Air vents shall be provided at all high points in the piping system for venting. Air vents shall be of gun metal construction and of automatic type. Similarly drain valves shall be provided at all dirty legs. The size of the



valves shall be 25 mm size for pipes upto 100 mm and 40 mm for sizes larger than 100 mm. Drain shall be closed with dummy caps to prevent accidental opening.

**CHECKLIST AND PERFORMANCE TEST DATA TO BE PROVIDED AFTER INSTALLATION**

<b>Sl. No.</b>	<b>Description</b>	<b>Unit</b>	<b>Remarks</b>
23.	Hydrostatic pressure conducted as per specification		
24.	Any leaks		
25.	Any defects in joints		
26.	Tested after rectifying defects		
27.	Test witnessed and certified		
28.	Any noise in piping system		
29.	Any water noise in coils		
30.	Any water noise in equipment		
31.	Proper flow achieved through AHU, Chiller, FCU		
32.	Piping insulation checked		
33.	All valves open		
34.	All motorised valves close / open		
35.	Expansion joints provided and checked		
36.	Pipe work cleaned		
37.	Water condition after pipe cleaning checked		
38.	Expansion tank Ball valve functional		
39.	All strainers clean		
40.	Pressure gauges working		
41.	Thermometers working		
42.	Drain points provided at Low points		
43.	Air vents provided at High points		
44.	Pipe support and spacing checked		
45.	Pipe material checked		

**45.0 MODE OF MEASUREMENT:**

45.1.1 Representatives from the Contractor and Engineer shall conduct a joint inspection of the Equipments. All the discrepancies observed either incomplete works or defective work shall be clearly indicated in the joint inspection report. The mode of measurements given below is for the purpose of measurement and payment and the scope of works shall be as specified else where in the specification.

## **45.2 Piping and Pipe insulation**

All water pipes and other pipes be measured nett length and measured linear over all fittings such as bends junction etc., and given in running metres. The length shall be taken along -With centre lines of the pipes and fittings. The unit rate shall include fittings (Elbows, Tees, bends, Mitres, Reducers, flanges, Gaskets, Bolts, Nuts, CAPS, Blind flanges and end closures). The measurements will be based on the approved drawing I as built drawing and paid per unit running metre. Length of other fittings (valves and strainers), which are paid under appropriate item, shall not be re-measured under linear measurement. The bill of quantities specified does not include any wastages during fabrication and erection. These shall be included by the tenderer in the unit rate. Also the unit rate quoted shall include piping insulation for chilled water piping and other pipes, no separate payment will be made for piping insulation.

## **45.3 Valves**

45.3.1 Each Valve including accessories shall be regarded as one unit. The quantity of valves will be based on the approved drawing I as built drawing for the purpose of measurement and payment. Also the unit rate quoted shall include valve insulation for valves in chilled water piping, no separate payment will be made for valve insulation. The unit rate quoted for motorized valves shall include cost of actuators, no separate payment will be made for valve actuators.

## **45.4 Strainers**

45.4.1 Each strainer including accessories shall be regarded as one unit. The quantity of strainer will be based on the approved drawing I as built drawing for the purpose of measurement and payment. Also the unit rate quoted shall include strainer insulation for strainers in chilled water piping, no separate payment will be made for strainer insulation.

## **45.5 Expansion tank**

45.5.1 Expansion tank with insulation and accessories as specified in the tender document will be regarded as one unit for the purpose of measurement and payment.

**END OF SECTION**

## **AIR DISTRIBUTION SYSTEM**

### **1.0 SCOPE**

This specification covers the general design, materials, construction features, manufacture, shop inspection and testing at manufacturer's works, delivery at site, installation, testing, commissioning and carrying out performance test at site of Air Distribution system.

### **2.0 CODES and STANDARDS**

The design, materials, construction features, manufacturer, inspection, testing and performance of air distribution system shall comply with all currently applicable statues, regulations, codes and standards in the locality where the system is to be installed. Nothing in this specification shall be construed to relieve the Contractor of this responsibility. In particular, the air distribution system shall conform to the latest edition of following standards.

IS 277	Galvanised Steel Sheet (Plain and corrugated).
IS 655	Metal Air Ducts.
IS 737	Wrought Aluminium and Aluminium Alloy sheet and strip for general engineering purposes.
SMACNA	HVAC Duct construction standards – Metal and Flexible.
SMACNA	HVAC Air duct leakage test manual.
SMACNA	HVAC systems – Testing, adjusting and balancing.
UL 181	Factory – Made Air ducts and connectors.
UL 555	Fire Dampers.
ASHRAE 70	Method of testing for rating the performance of Air Outlets and inlets.

### **3.0 MATERIAL REQUIREMENT**

Ducting shall be fabricated from Galvanised steel sheet (GSS) as specified.

- a. GSS duct shall be of lock forming grade, zinc coated conforming to IS 277 coating grade 180 or better.

### **4.0 CONTRUCTION FEATURES**

Fabrication details shall be generally in accordance with the details given here under.

#### 4.1 RECTANGULAR DUCT

a. For Low Pressure System (upto Fan external static pressure of  $\pm 75$ mm WC).

LARGER SIDE OF DUCT mm	THICKNESS OF SHEET mm/G		TYPE OF TRANSVERSE JOINT	TYPE OF REINFORCEMENT
	GSS / SS	AL		
Upto 250	0.63 / 24	0.80 / 22	25x25x3mm MS angle flanged joint	--
251 to 750	0.63 / 24	0.80 / 22	25x25x3mm MS angle flanged joint	25x25x3mm MS angle @ 1250 mm c/c.
751 to 1000	0.80 / 22	1.00 / 20	25x25x3mm MS angle flanged joint	40x40x3mm MS angle @ 1250 mm c/c.
1001 to 1500	0.80 / 22	1.00 / 20	40x40x3mm MS angle flanged joint	40x40x3mm MS angle @ 750 to 800 mm c/c.
1501 to 2100	1.00 / 20	1.25 / 18	40x40x3mm MS angle flanged joint	50x50x6mm MS angle @ 750 to 800 mm c/c.
2101 to 2400	1.25 / 18	1.50 / 16	65x65x6mm MS angle flanged joint	65x65x6mm MS angle @ 750 to 800 mm c/c.
Greater than 2401	1.25 / 18	1.50 / 16	50x50x3mm MS angle flanged joint with tie rod(s) of 10 mm dia.	50x50x3mm MS angle @ 750 to 800 mm c/c with the rod(s) of 10mm dia, evenly spaced along reinforcing angle, spacing not exceeding 1500 mm.

b. For High pressure system duct (Fan external static pressure of +76 to +250mm WC)

LARGER SIDE OF DUCT mm	THICKNESS OF SHEET mm/G		TYPE OF TRANSVERSE JOINT	TYPE OF REINFORCEMENT
	GSS / SS	AL		
Upto 600	0.80 / 22	1.00 / 20	40x40x3mm MS angle flanged joint	40x40x3mm MS angle @ 750 to 800 mm c/c.
601 to 1200	1.00 / 20	1.25 / 18	50x50x3mm MS angle flanged joint	50x50x3mm MS angle @ 600 mm c/c
1201 to 1500	1.25 / 18	1.50 / 16	50x50x3mm MS angle flanged joint	50x50x3mm MS angle @ 600 mm c/c
1501 to 2000	1.50/16	1.80 / 14	65x65x6mm MS angle flanged joint	50x50x3mm MS angle @ 600 mm c/c
Greater than 2001	1.50 / 16	1.80 / 14	50x50x3mm MS angle flanged joint with tie rod(s) of 10 mm diameter.	50x50x3mm MS angle @ 600 mm c/c with tie rod(s) of 10mm diameter, evenly spaced along reinforcing angle, spacing not exceeding 1500 mm.

- c. Longitudinal seams shall be Pittsburgh lock type at corners as shown on sheet. Longitudinal joints shall not be provided for rectangular ducting at locations other than corners, except where larger side of duct exceeds 2500mm. Longitudinal joints of ducting having side larger than 2500mm other than corner shall be grooved or standing seam as shown.

If specified, sealing of the longitudinal seams shall be accomplished using Dow coming RTV 732 Silastic or equivalent.

- d. All circumferential joints shall be MS angle flanged joints.
- e. Flanges used for transverse joints shall be joined with each other with Galvanised Steel (GS) bolts, washers and nuts. The bolts shall be of minimum M8 size and the spacing between bolts shall be maximum 150 mm for low pressure system and 100 mm for high pressure system.
- f. For transverse angle flanged joints, neoprene gasket (3mm uncompressed thickness and width equal to flange face) adhered to the flange face shall be used. The bolt holes in gasket shall be the same as bolt diameter and shall be punched prior to insertion of gaskets.
- g. All flanges shall be applied with two coats of zinc-chromate, silver or zinc paint. (Red oxide is prohibited)
- h. Angles shall have welded corners and shall be riveted to the ducts at 300mm centres. (maximum).
- i. For SS ducts all related appurtenances such as transverse joint angles, reinforcement angles, fasteners, turning vanes, access doors, etc. shall be of the same material as of duct.
- j. Ducts shall be fabricated using lock forming machine.

#### 4.2 ROUND DUCT

- a. Round duct thickness in mm/G for GSS/SS shall be as given below:

DUCT DIAMETER mm	UPTO 50 mmWC STATIC PRESSURE POSITIVE		51 to 250mmWC STATIC PRESSURE POSITIVE		UPTO 50 mmWC STATIC PRESSURE NEGATIVE	
	SPIRAL SEAM	LONGITUD I-NAL SEAM	SPIRAL SEAM	LONGITU DI-NAL SEAM	SPIRAL SEAM	LONGITU DI-NAL SEAM
Upto 200	0.42 / 28	0.42 / 28	0.51 / 26	0.63 / 24	0.42 / 28	0.63 / 24
201 to 350	0.42 / 28	0.51 / 26	0.51 / 26	0.63 / 24	0.51 / 26	0.63 / 24
351 to 650	0.51 / 26	0.63 / 24	0.63 / 24	0.80 / 22	0.63 / 24	0.80 / 22
651 to 900	0.63 / 24	0.80 / 22	0.80 / 22	1.00 / 20	0.80 / 22	1.00 / 20
901 to 1250	0.80 / 22	1.00 / 20	1.00 / 20	1.00 / 20	1.00 / 20	1.25 / 18
1251 to 1500	1.00 / 20	1.25 / 18	1.25 / 18	1.25 / 18	1.25 / 18	1.50 / 16
1501 to 2100	1.25 / 18	1.50 / 16	1.25 / 18	1.50 / 16	1.50 / 16	1.80 / 14

b. Round duct thickness in mm/G for aluminium sheet shall be as given below:

DUCT DIAMETER mm	MAXIMUM 50 mmWC STATIC PRESSURE POSITIVE		MAXIMUM 50mmWC STATIC PRESSURE NEGATIVE	
	SPIRAL SEAM	LONGITUDINAL SEAM	SPIRAL SEAM	LONGITUDINAL SEAM
Upto 200	0.63 / 24	0.80 / 22	0.63 / 24	1.00 / 20
201 to 350	0.63 / 24	0.80 / 22	0.80 / 22	1.00 / 20
351 to 650	0.80 / 22	1.00 / 20	1.00 / 20	1.25 / 18
651 to 900	1.00 / 20	1.25 / 18	1.25 / 18	1.50 / 16
901 to 1250	1.25 / 18	1.25 / 18	1.25 / 18	1.50 / 16
1251 to 1500	1.50 / 16	1.50 / 16	--	2.25 / 12
1501 to 2100	--	2.25 / 12	--	--

c. Round duct shall have longitudinal or spiral seam, as specified Data Sheet – A. Longitudinal and spiral seam shall be as shown on sheet.

d. Angle flanges shall be used for transverse joints and shall be joined with each other with GS nuts and bolts. Angle shall be minimum 25x25x3mm for ducts size upto 250mm and minimum 40x40x3mm for ducts size greater than 350mm.

e. For transverse angle flanged joints, neoprene gasket (3mm uncompressed thickness and width equal to flange face) adhered to the flange face shall be used. The bolt holes in gasket shall be the same as bolt diameter and shall be punched prior to insertion of gaskets.

- f. All flanges shall be applied with 2 coats of zinc-chromate, silver or zinc paint. (Red oxide is prohibited.)
- g. For SS ducts all related appurtenances such as transverse joint angles, reinforcement angles, fasteners, turning vanes, access doors, etc. shall be of the same material as of duct.
- h. Ducts shall be fabricated using lock forming machine.

4.3 DUCT SUPPORTS and HANGERS

- a. Rectangular duct shall be supported from ceiling using trapeze hangers. Ducts shall rest on supporting angle or channel and this supporting angle or channel shall be supported by CS rods or angles or channels on both sides of ducts with weld or bolts.

Supporting details for low-pressure system shall be as given below.

LARGER SIDE OF DUCT mm	SUPPORTING ANGLE mm	VERTICAL ROD DIAMETER mm	MAXIMUM SPACING BETWEEN SUPPORTS mm
Upto 900	40x40x6	10	3000
901 to 1500	50x50x6	10	3000
1501 to 2400	50x50x6	10	2400
2401 and above	65x65x6	12	2400

Supporting details for high pressure system shall be as given below:

LARGER SIDE OF DUCT mm	SUPPORTING ANGLE mm	VERTICAL ROD DIAMETER mm	MAXIMUM SPACING BETWEEN SUPPORTS mm
Upto 1250	50x50x6	15	2400
1251 to 2100	65x65x6	15	2400
2101 and above	Mc 75x6	15	2400

- b. Round duct shall be supported using single or two hanger straps or rods. Straps and rods shall be of GSS.

Supporting details for round duct shall be as given below.

DUCT DIAMETER mm	STRAP			ROD	
	Nos.	WIDTH mm	THICKNESS G	Nos.	DIAMETER mm
Upto 600	1	25	22	1	7
601 to 900	1	25	20	1	10
901 to 1250	2	25	20	2	10
1251 to 1500	2	25	18	2	10
1501 to 2100	2	25	16	2	10

- c. Zinc coated anchor fasteners or embedded plates shall be provided for upper attachments to the building. Anchor fasteners shall be provided by Contractor. Embedded plates shall be provided by Contractor. Contractor shall provide duct supports from angle cleats welded to the embedded plates. Anchor fasteners shall be loaded to maximum 20% of the maximum rated capacity specified by the manufacturer. Site Engineer shall approve all anchor fasteners used for supporting duct.
- d. In case of insulated duct, anchor fasteners shall be selected based on actual total load.
- e. Duct supports shall be qualified and sized for seismic forces, if specified in Data Sheet – A.

#### 4.4 FLEXIBLE CONNECTIONS (Metal Duct connections to Supply / Exhaust Fan)

Where sheet metal duct connects to the intake or discharge of fan units, a flexible of fire retarding double layer heavy duty canvas of at least 150 mm width shall be provided. The material shall be attached to angle frames by means of steel and over the end of the flexible connection. The material shall be secured between the band and the angle frame by bolting. Sleeve shall be made smooth and the connecting duct work rigidly held by independent supports on both ends. The flexible connection shall be suitable for fan intake and outlet pressures.

#### 4.5 TRANSFORMATION

Duct transformation shall be used to change the shape of duct and shall be made for easy and noiseless flow of air. Maximum slope of transformation shall be 1:4

#### 4.6 BENDS, OFFSETS and BRANCH CONNECTIONS

All bends, offsets and branch connections shall be made for smooth and noise less flow of air and minimum pressure drop. In case of full radius elbow optimum ratio of centreline radius of elbow to duct dimension of 1.25 shall be considered. However, due to space constraint shorter radius constraint shorter radius elbow or square elbow with guide vanes may be provided. Contractor shall furnish the details of guide vanes i.e. number of vanes,



location etc. in the drawing. The flow of air to the branch duct shall be regulated by a splitter damper or volume control damper.

#### 4.7 SPLITTER DAMPERS and VOLUME CONTROL DAMPERS (VCDs)

- a. Splitter dampers shall be fabricated of minimum 18G GSS and shall be of robust construction. The position of splitter damper shall be adjusted by use of the splitter rod.
- b. VCD shall be fabricated of minimum 18G GSS and shall be of robust construction. VCD shall be single blade type for round duct and opposed blade type for rectangular duct. VCD shall have a locking device mounted outside the duct to hold the VCD in a fixed position without vibration. Fully open and fully closed position shall be marked for easier operation of VCD.
- c. Motor operated VCD shall be provided, if specified. Actuator for dampers shall develop sufficient torque for easy operation of VCD.
- d. VCD shall be provided with Teflon or brass bushing for blade shaft as specified in Data Sheet – A. Motor operated VCD shall be provided with Teflon bushing or sealed ball bearing for blade shaft as specified in Data Sheet – A. (Optional)
- e. For SS duct, all splitter dampers and VCDs shall be fabricated from SS 304 sheet.
- f. Volume control dampers shall be provided in every branch duct from individual main ducts. Volume control dampers shall also be provided in branch duct from main connecting to individual supply / exhaust air outlets, and inlets, fresh air intake duct, etc.
- h. Flexible ducts

Insulated flexible ducts shall be provided to connect the supply air ducts to all air delivery devices such as grilles and diffusers. The length of the flexible duct shall not exceed 2.5 m. The airflow velocity through the flexible duct shall not be more than 3.0 m/s.

The flexible duct shall be made of triple lamination of aluminium foil, polyester and Metalised Polyester film permanently bonded to a coated spring steel wire helix. The exterior shall be wrapped with 25mm thick 32 kg / m<sup>3</sup> fibreglass insulation. The outer insulation jacket / vapour barrier shall be made of fibreglass reinforced Metalised Polyester film laminate. The fire rating of the flexible duct shall conform to BS 476 Parts 5, 6 and 7.

- i. Very branch duct shall have test plugs.
  - j. Every duct tap-off from supply and return air duct shall be complete with opposed blade volume contract damper.
  - k. The duct leakage rate shall not exceed 1% of full flow and 25% of the ducts shall be tested at site for duct leakage.
- l. CAULKING and DRAIN

Wherever duct passes through wall or slab, all the openings between masonry and duct work shall be neatly caulked or sealed by the Contractor to prevent movement of air from one space to the adjoining space. Where duct

passes through the floor, a drain trap of 100mm width across the width of the duct and 50mm depth shall be provided with a suitable plug at the lowest point in the elbow.

#### 4.9 ACCESS DOOR

Access door shall be provided in duct before and after equipment installed in duct and at all fire damper locations. All access doors shall be fabricated of the same material as the duct work and shall have minimum two hinges. Hinges shall be zinc plated and pins shall be of brass. Access doors shall be of minimum of 305 mm x 305 mm size. At least two heavy solid brass fasteners and a brass handle are required for each door. A continuous neoprene rubber gasket shall be adhered to the opening frame with adhesive.

#### 4.10 DIFFUSERS AND GRILLES (AIR DIFFUSION EQUIPMENT)

- a. The type and quantity of diffusers and grilles shall be provided, as specified in the drawing. The contractor shall ensure that the diffusers and grilles offered are of requisite capacity, throw and terminal velocity. Diffusers and grilles shall be fabricated from CS, factory coated with rust resistant primer or extruded aluminium section with powder coating or SS 304, as specified in the drawing.

Whenever VCD is provided with diffusers or grilles it shall be located within the duct collar. Diffusers and grilles shall be of flush pattern,.

Ceiling diffuser shall be equipped with fixed air distribution grids, removable key operated volume control dampers and anti-smudge rings. The extruded aluminium or SS 304 diffusers shall be provided with removable central core and concealed key operation for volume control damper.

- b. Linear diffusers shall be of extruded aluminium or SS 304 construction.
- c. Slot diffuser shall be of extruded aluminium or SS 304 construction multi-slot type with air pattern controller provided in each slot. Supply air slot diffusers shall be provided with hit and miss VCDs in each slot.
- d. Grilles with VCD shall be single acting or double acting, as specified in the drawing. Grilles without VCD shall have fixed blades or adjustable blades, as specified in the drawing.
- e. All diffusers, grilles and registers shall be of extruded aluminium construction, and epoxy powder coated.

Aluminium registers, diffusers and grilles shall be approved by Architect. The shade of epoxy powder coating for grilles, registers and diffusers shall be approved by Architect.

All ceiling diffusers shall be of the louver face type with removable core complete with opposed blade volume control dampers. The diffuser surface shall be completely flush with the false ceiling.

Supply registers shall be of the rectangular universal type with adjustable horizontal and vertical vanes complete with opposed blade volume control dampers. Dampers shall be adjustable by a removable key or screwdriver from the face of the registers.

Fresh air and discharge air grilles shall be of the fixed single louver type with opposed blade volume control dampers adjustable from the face of the grilles. All diffusers, registers and grilles shall be selected to account for the noise levels as specified for various area.

For areas where square ceiling diffusers are used, they shall be of the louver face type with removable core complete with opposed blade volume control damper.

Air terminals (square diffusers) for the VAV system (wherever applicable) shall be selected to be compatible with the characteristics of the VAV box i.e., the outlet must be capable of performing at full airflow as well as reduced air flow. Linear diffusers shall be used with VAV Boxes.

Supply air register shall be of the rectangular universal type with adjustable horizontal and vertical vanes complete with opposed blade volume control dampers. Dampers shall be adjustable by a removable key or screw driver from the face of the register.

Outdoor air grilles shall be of the fixed single louver type with opposed blade volume control dampers adjustable from the face of the grilles.

#### 4.11 PLENUMS

Plenums shall be factory fabricated of 18G GSS for low-pressure system and 16G GSS for high-pressure system. Type of reinforcement and supporting details shall be as per clause 4.1 and 4.3. Plenums shall be constructed to withstand 133% of rated plenum pressure without structural failure. Wall and roof deflection at rated pressure shall not exceed 10mm per meter of width.

#### 5.0 INSPECTION AND TESTING

- a. The ducts, branches, elbows etc. shall be inspected and the joints and connection shall be checked before these are assembled in position. After assembly the system shall be checked for tightness, vibration and noise.
- b. Changes in direction shall be made with elbows with an inside radius equal to the width of the duct, where possible, but where space does not permit this radius, sharper or right – angle bends within inside radius not less than 1 of the duct width which may be used with double thickness aerofoil turning vanes. The turning vanes shall have a flange covering the whole base and they shall be riveted to the duct at not more than 75 mm intervals. Insecurely fitted turning vanes shall be rejected. All changes in dimensions and shape of ducts shall be done in a gradual manner and to approval.
- c. Ductwork shall be free from waves or buckles and the sheet metal is to be machine – bent to ensure neat and accurate fabrication. If double thickness aerofoil shape internal stiffeners are fitted, the original ‘cross sectional area of duct shall be maintained.
- d. Full sized standard sheets of the gauges specified are to be used and any patched or made-up pieces of duct work are liable to be rejected. Joints between flanged connections shall be fitted with neoprene rubber gaskets of 5 mm thick.
- e. All duct work not insulated shall be painted externally with one coat of primer and two coats of anticorrosive paint.
- f. All duct surfaces behind diffusers, registers and grilles shall be painted Matt black.
- g. All toiler riser ductwork shall be of soldered or welded seams and joints throughout.

- h. Duct joints and seams shall be made air tight by use of sealants acceptable to local authority. Test points shall be provide at the discharge of each air handling unit and at each individual zone of the duct work system. Test points shall consist of 25 mm diameter sockets fitted with sealing plugs which can be removed for the fitting of measuring devices. Test points shall be insulated as for the ductwork and shall be provided with identification labels.
- i. Duct dimensions and drawings.  
The contractor shall furnish duct layout drawings showing clear internal sizes for all air-conditioned as well as areas covered by MV.
- j. Rectangular risers should be supported by angles or channels secured to the sides of the ducts with welds, bolts sheet metal screws or blind rivets. Riser support intervals should be one or two storey height.
- k. In case embedded plates are provided contractor shall provide support from angle cleats welded to embedded plates.
- l. Ducts shall have support on either side of elbow within two feet and for branch connection it shall be within four feet.

m. Turning Vanes

All curved elbows shall be provided with air turning vanes consists of curved metal blades or vanes arranged so as to permit the air to make abrupt turns without appreciable turbulence.

All right angle elbows shall be provided with double thickness aerofoil turning vanes extending over at least 50 percent of the while curvature of the elbow. The turning vanes shall have a flange covering the whole base be rivetted to the duct at not more than 60 mm centres.

- n. Sound Attenuators (Dissipative Type) to be provided on the discharge side of all AHU fans and ventilation fans and also in return air ducts connected to AHU rooms.
- o. Sound attenuators shall consist of an outer casing, sound absorbing material and internal baffles, splitters and supports. Casings shall be of galvanised steel of not less than 20 g. thickness. Casings shall be tested to 150 mm wg. and shall show no leakage, or distortion in this condition. Duct sealing compound shall be furnished by the supplier for sealing all silencers on site, where necessary, as determined by the ENGINEER.
- p. Sound absorbing material shall be high-density fibreglass held in place with at least 5% compression to prevent voids due to settling. Absorption material density shall be minimum 48 kg / cu.m fibreglass faced with minimum 26 g. perforated galvanised sheet metal of minimum 40% open area. Combustion rating for the silencer acoustic infill shall not be less than the following, when tested in accordance with ASTM E84:

Flame spread classification	-	25
Smoke development rating	-	0
Fuel contribution	-	20

- q. The supplier shall supply certified test data on dynamic insertion loss and self-noise with an airflow of at least 7.62 m/sec. (1500 ft / min) face velocity. Ratings shall be determined in a duct-to-reverberant room test facility, which provide for airflow through the test silencers during rating.

## **6.0 BALANCING**

- a. The air distribution system shall be tested and balanced so that the requisite temperature and air flow are maintained throughout the space to be air-conditioned or ventilated.
- b. During start-up phase, Contractor shall make all arrangement for drilling or plugging of all test opening or holes, adjustment of VCDs, adjusting of fan speed to obtain specified flows, obtaining actual motor ampere readings, and all related functions to ensure the proper operation of all systems.
- c. Test holes for system commissioning shall be minimum 20mm diameter to accept a standard pitot tube of 8mm diameter and each hole shall be fitted with an effective removable type seal. Location of test holes shall be decided by Contractor in consultation with Contractor / Engineer.
- d. All instruments required for testing and balancing of air distribution system shall be provided by the Contractor.
- e. Complete air balance report shall be submitted for scrutiny and approval. Four copies of the approved balance report shall be provided with completion documents.
- f. Splitter damper and VCD adjustments shall be permanently marked after air balancing is complete so that these can be restored to their correct position if disturbed at any time.

## **7.0 VARIABLE AIR VOLUME (VAV) BOXES (wherever applicable)**

- a. These shall of the low velocity variable air volume boxes without re-heat coils, and shall be a proprietary line as marketed by a firm specialising in this field. The contractor shall supply and install units to the quantity and locations as specified (minimum 10 units for each AHU).
- b. Boxes shall be of variable air volume at the inlet and variable at the outlet and shall be fitted with air volume regulator of the fully proportional hype. The boxes shall be rated by Air Diffusion Council (ADC) of Chicago, USA and within the makes specified.
- c. Boxes shall be supplied with all internal attenuation treatment and acoustical damped casing necessary to achieve the required noise criteria. Casing shall be of 20 BG minimum fitted with a completely sealed, easily removable means of access to all internal parts. Access to all boxes must be from the underside only.
- d. Maximum allowable static pressure to the boxes for its satisfactory operation shall not exceed 0.20 “ W.G. otherwise fan and motor selections may be affected.
- e. Boxes shall be able to reset any air flow between zero and the maximum air quantity that the boxes can handle without changing orifices or other parts. Air quantity limiters will not be accepted.
- f. A suitable device shall be provided for the field adjustment of minimum air flow. All boxes shall be initially factory set at minimum air quantity of 50% of the design requirements. Under shut-off conditions, all boxes shall not have air leakage more than 20% of the maximum air quantity.

- g. All boxes shall be electrically controlled. Controllers and operators shall be supplied by the SUB-CONTRACTORS. The boxes shall be pressure independent.

FIG.2-MEDIUM PRESSURE,HIGH VELOCITY RECTANGULAR DUCT CONSTRUCTION FOR STATIC PRESSURES FROM 50-150mm WG									
REINFORCING									
B/W JOINTS					AT JOINTS				
DIMENSION OF LONGEST SIDE OF DUCT IN mm	GALVANISED IRON SHEET METAL THICKNESS IN mm	MINIMUM REINFORCING ANGLE SIZE AND MAXIMUM LONGITUDINAL SPACING	INSIDE SLIP JOINT	WELDED FLANGE	STANDING SEAM	REINFORCED STANDING SEAM	FLANGED JOINT	POCKET LOCK	CONNECTION FLANGE
UP THRU 300		WITHOUT TIE RODS NO ANGLE REQUIRED	MINIMUM ANGLE SIZE NO ANGLE REQUIRED	MINIMUM HEIGHT	MINIMUM HEIGHT	MINIMUM HEIGHT	MINIMUM HEIGHT	MINIMUM HEIGHT	MIN. ANGSIZE
301-460	0.71	NO TIE RODS REQUIRED 1 TIE ROD AT 1200 INTERVAL ON CENTER LINE OF DUCT SIDE	50x50x3 50x50x3	16 22	25 25	25 25	25 25	25 25	30x30x3 30x30x3
461-610	0.86	1 TIE ROD AT 1200 INTERVAL ON CENTER LINE OF DUCT SIDE	50x50x3 50x50x3	35	30	30	30	30	30x30x3
611-900	0.86	→	35x35x3 AT 1200	30 WITH TIE ROD IN CENTRE 810x810x3	40	40	40	40	30x30x3
911-1200	0.86	→	35x35x3 AT 760	30 WITH TIE ROD IN CENTRE 40x40x3	50 OR 40 WITH TIEROD AT CENTRE	40	50	-	30x30x3
1201-1520	1.02	WITH TIE ROD IN CENTER 35x35x3 AT 600	50x50x3 AT 600	35 WITH TIE ROD IN CENTRE 50x50x3	40 WITH TIEROD IN CENTRE	40	40 WITH TIE ROD IN CENTRE	-	40x40x3 30x30x3 30x30x3
1521-1830	1.02	WITH TIE ROD IN CENTER 35x35x3 AT 600	65x65x5 AT 600	35 WITH 2 TIE RODS IN CENTRE 65x65x5	50 WITH TIEROD IN CENTRE	40	40 WITH TIE ROD IN CENTRE	-	30x30x3 30x30x3 30x30x3
OVER 1830	1.32	WITH TIE ROD IN CENTER 35x35x3 AT 600	65x65x5 AT 600	35 WITH 2 TIE RODS IN CENTRE 65x65x5	50 WITH TIEROD IN CENTRE	40	40 WITH TIE ROD IN CENTRE	-	30x30x3 30x30x3 30x30x3

**FIG.1-LOW PRESSURE-LOW VELOCITY SHEET METAL  
DUCTWORK CONSTRUCTION DETAILS**

DIMENSION OF LONGEST SIDE OF DUCT IN mm	GALVANISED IRON SHEETMETAL THICKNESS IN mm	PLAIN 'S' SLIP(B)		HEMMED 'S' SLIP(C)		ANGLE SLIP(H)		GASKET COMPANION ANGLES(M)	REINFORCING ANGLE SIZE AND MAXIMUM LONGITUDINAL SPACING BETWEEN TRANSVERSE JOINT AND/OR INTERMEDIATE REINFORCING
		POCKET LOCK(K)	BAR SLIP(E)	REINFORCED BAR SLIP(G) *	ALTERNATE BAR SLIP(F)				
THRU 300	0.71	A-B K	-	-	-	-	-	-	-
301 THRU 460	0.71	A-B K	-	-	-	-	-	-	-
461 THRU 760	0.71	K	C-E	-	-	-	-	-	25x25x3 AT 1.5m cc
761 THRU 1070	0.86	K	E-C-I	-	-	-	-	-	25x25x3 AT 1.5m cc
1071 THRU 1370	0.86	K	E	G	-	-	-	-	35x35x3 AT 1.5m cc
1371 THRU 1520	1.02	K	E	G	-	-	-	-	35x35x3 AT 0.8m cc
1521 THRU 2130	1.02	-	-	G	H F L	-	J	-	35x35x3 AT 0.8m cc
2131 THRU 2440	1.32	-	-	-	H L	-	M J	-	35x35x3 AT 0.8m cc
OVER 2440	1.32	-	-	-	H L	-	M J	-	50x50x6 AT 0.8m cc

**NOTES:**

H : (HEIGHT DIMENSION) UPTO 1070=25  
H : (HEIGHT DIMENSION) 1090 TO 2440=40  
H : (HEIGHT DIMENSION) OVER 2440=50  
\* : ROLLED FORMED SLIP SHALL BE 400  
MAXIMUM AND 50 REINFORCING ANGLE  
ANGLE FASTENED TO SLIP WHEN "H"  
DIMENSION REQUIRES 50 HEIGHT

**46.0 CHECKLIST AND PERFORMANCE TEST DATA TO BE PROVIDED AFTER INSTALLATION**

No	Description	O.K	Needs Attention	Not Applicable	Remarks
11.	Duct Work clean				
12.	Sealed, No leaks, Tight connection .				
13.	Fire Dampers open				
14.	Access doors closed				
15.	Lined ducts				
16.	Flexible duct connected, No Tears				
17.	System balanced				
18. a	Short circuiting or other Air Distribution problems				
b	Note locations.				
19.	VCD provided as per specification				
20.	VCD all open and adjusted				
21.	Supply / Return / Exhaust outlets / Inlets balanced				
22.	Noticeable flow of Air				
23.	Air balance report submitted with details				
24.	VAV Box a. Minimum stops - % b. Maximum opening - %				
25.	Controls working				
26.	Thermostats				
a.	Type				
b.	Properly located				
c.	Working				
d.	Set point - °C				
e.	Space temperature - °C				
27.	Duct insulation checked				
28.	Duct supports and hangers checked including spacing				



29.	Turning valves provided in elbows.				
30.	Test witnessed and certified				

**MODE OF MEASUREMENT:**

1.0 Representatives from the Contractor and Engineer shall conduct a joint inspection of the Equipments. All the discrepancies observed either incomplete works or defective work shall be clearly indicated in the joint inspection report. The mode of measurements given below is for the purpose of measurement and payment and the scope of works shall be as specified elsewhere in the specification.

**1.1 Air-distribution system**

**1.1.1 Ducting**

The following procedure for measurement shall be followed for purpose of billing in case of items subject to variation in quantities.

Payment for ducting shall be on the basis of the external surface area of the ducting.

The rate per square meter of the external surface shall include flanges, gaskets for joints, bolts and nuts, duct supports and hangers. Vibration isolation pads or suspenders; flexible connections, inspection doors, dampers, turning vanes, straightening vanes and any other item which will be required to complete the duct installation except external insulation and finish thereon.

The external area shall be calculated by measuring the over-all width and depth (including the corner joints) in the center of the duct section and over-all length of each duct section from flange face to flange face in case of duct lengths with uniform cross section. Total area will be arrived at by adding up the areas of all duct sections.

In case of taper pieces average width and depth will be worked out as follows:

W1 = Width of small cross section

W2 = Width of large cross section

D1 = Depth of small cross section

D2 = Depth of large cross section

$$\text{Average Width} = \frac{W1 + W2}{2}$$

$$\text{Average Depth} = \frac{D1 + D2}{2}$$

Width and depth in the case of taper pieces shall be measured at the edge of the collar of the flange for duct / sections fitted with angle iron flanges; otherwise at the bottom of the flange where the flanges are of GSS. Face to face length for taper piece shall be the mean of the lengths measured face to face from the centre of width and depth flanges.

For special pieces like bends, branches, and tees, etc, the same principal of area measurement as for linear lengths shall be adopted, except for bends and elbows, the length of which shall be the average, of the lengths of inner and outer periphery along the curvature of angle of the piece.

Duct measurements for calculation of area shall be taken before application of insulation.

#### **1.1.2 Supply air Diffusers**

Each supply air diffuser including volume control dampers, flexible ducting, adopter box and accessories as specified will be regarded as one unit for the purpose of measurement and payment. The measurements will be based on the approved drawing *I* as built drawing and paid per unit. Flexible ducting and adopter box (connecting flexible ducting and supply air diffuser) are part of supply air diffuser. The unit rate quoted for supply air diffusers shall include the cost of adopter box and flexible ducting. No separate payment will be made for flexible ducting and adopter box.

#### **1.1.3 Return air Diffusers**

Each return air diffuser and accessories as specified will be regarded as one unit for the purpose of measurement and payment. The measurements will be based on the approved drawing *I* as built drawing and paid per unit.

#### **1.1.4 Fire Dampers**

Fire dampers shall be measured by their cross-sectional area perpendicular to air flow based on the approved drawing *I* as built drawing and paid. Quoted rates shall include necessary accessories and flanges for mounting, access door etc.

#### **1.1.5 Fusible link and solenoid for operation of Fire Dampers**

Each Solenoid and associated accessories will be regarded as one unit for the purpose of measurement and payment. Each Fusible link and associated accessories will be regarded as one unit for the purpose of measurement and payment. The measurements will be based on the approved drawing *I* as built drawing and paid per unit.

#### **1.1.6 Linear Diffusers**

Linear diffusers shall be measured by linear measurements only and not by cross-sectional areas and shall exclude flanges for mounting linear diffusers. The measurements will be based on the approved drawing *I* as built drawing and paid per unit length. The supply air plenum for linear diffusers shall be measured identical to ducting as described earlier. Frame work for linear diffusers shall be included in unit rates quoted.

#### **1.1.7 Slot Diffusers**

Slot diffusers shall be measured by linear measurements only, not by cross-sectional areas and shall exclude flanges for mounting slot diffusers. The measurements will be based on the approved drawing *I* as built drawing and paid per unit length. The supply air plenum for slot diffusers shall be measured identical to ducting as described earlier. Frame work for slot diffusers shall be included in unit rates quoted.

#### **1.1.8 Supply and return air Grilles**

Supply and Return air grille area shall be calculated by measuring width by height, excluding flanges. In case of supply air grilles, volume control dampers shall form part of supply air grilles and the unit rates quoted for supply

air grilles shall include the cost of volume control dampers. Frame work for grilles shall be included in unit rates quoted. The measurements will be based on the approved drawing *I* as built drawing and paid per unit area.

#### **1.1.9 Volume control damper (VCD) in Duct**

VCD (manual or motorised) shall be measured by their cross-sectional area perpendicular to air flow based on the approved drawing *I* as built drawing and paid per unit area. Quoted rates shall include necessary collars and flanges for mounting etc. No special allowance shall be payable for extension of cross-section outside the air stream. Volume control dampers in supply and exhaust fan units are part of fan units and no separate payment will be made for the same.

#### **1.1.10 Back draft damper**

Back draft damper shall be measured by their cross-sectional area perpendicular to air flow based on the approved drawing *I* as built drawing and paid per unit area. Quoted rates shall include necessary collars and flanges for mounting etc. No special allowance shall be payable for extension of cross-section outside the air stream.

#### **1.1.11 Variable Air Volume (VAV) unit**

Each Variable Air Volume (VAV) box with dampers, accessories etc, will be regarded as one unit for the purpose of measurement and payment.

#### **1.1.12 Sound Attenuators**

Each Sound attenuator with accessories will be regarded as one unit for the purpose of measurement and payment. The measurements will be based on the approved drawing *I* as built drawing and paid per unit. Sound attenuators in supply and exhaust fan units are part of fan units and no separate payment will be made for the same.

#### **1.1.13 Flexible Connection**

Flexible Connections other than at equipment inlet and outlet shall be measured by their cross-sectional area perpendicular to air flow. Quoted rates shall include necessary mounting arrangement, flanges, nuts and bolts and treated for fire requisite length of canvas cloth. The measurements will be based on the approved drawing *I* as built drawing and paid per unit area.

#### **1.1.14 Louvers**

Louvers complete with bird screen etc., shall be measured from the approved drawings / as built drawing on the basis of core area (excluding margin flanges) and paid per unit area. Louvers in supply and exhaust fan units are part of fan units and no separate payment will be made for the same.

#### **1.1.15 Strip Heater**

Strip heaters if specified including accessories will be measured from the approved drawing *I* as built drawing in KW and paid per unit KW.

**END OF SECTION**

## INSULATION SPECIFICATIONS

### 1 SCOPE

This specification covers the technical requirements and essential particulars for the supply, application and finishing of the composite thermal insulation for cold equipment, piping systems, air-conditioning ducts, etc. The scope of supply of the contractor shall include, but not be limited to, the following items:

- (a) Insulation material as specified
- (b) Finishing material as specified
- (c) Auxiliary materials such as binding and lacing wires, wire netting, bands, screws, pop-rivets, etc. as required
- (d) Angles, clamps, lugs, etc. for supporting insulation
- (e) Weather hoods
- (f) Any material as may be required for making the insulation complete

### 2.0 CODES AND STANDARDS

The following are some of the codes and standards relevant to this specification:

IS 277	Galvanised Steel Sheet (Plain and Corrugated)
IS 737	Wrought Aluminium and Aluminium alloy Sheet and Strip for General Engineering Purposes
IS 8183	Bonded Mineral Wool
IS 9842	Preformed Fibrous Pipe Insulation
IS 14164	Industrial Application and finishing of Thermal Insulation Materials at Temperatures above (-) 80 <sup>0</sup> C and up to (+) 700 <sup>0</sup> C
BS 5970	Thermal Insulation of Pipe work and Equipment (in the Temperature Range (-) 100 <sup>0</sup> C to (+) 870 <sup>0</sup> C

### 3.0 INSULATION WORK

- 1) The scope of this section comprises supply and application of insulation to sheet metal ducting, chilled water piping, condensate drain piping, refrigerant piping, insulation for air handling units, chillers, insulation for walls and ceiling and floor.
- 2) Nitrile Rubber Insulation of Class "O" Closed Cell, 32 mm thick for pipes above 100 mm Dia & insulation of 25 mm thick for pipes below 100 mm Dia. The pipe insulation shall be covered with 26 Gauge Aluminium Cladding with superior workmanship.

- 3) Duct insulation of Closed Cell Rubber Nitrile Class O Armaflex make. The insulation shall have factory pasted wrinkled Aluminium Foil finish.
- 4) All insulation on equipment and piping shall be applied only after the system has been pressure tested satisfactorily.
- 5) The consultants / owners or their authorized representatives reserve the right to peruse the weights, dimensions etc., of the insulation material supplied. Samples of all insulation material specified, in various forms shall be submitted by the successful contractor. The customers / consultants shall have the right to reject all supplies which do not conform to the specifications and to the samples so approved.

External (Thermal) insulation of air-conditioning ducts:

The entire supply air ducting for air-conditioning from AHU fan outlet to the terminal device (diffuser or grille) shall be insulated Closed Cell Rubber Nitrile Class O Armaflex make. The insulation shall have factory pasted wrinkled Aluminium Foil finish 19 mm. The thermal conductivity (K) value shall not be more than 0.033 W/m .k. at 10 deg C.

Internal (Acoustic) insulation of air-conditioning ducts :

Acoustic insulation shall be provided for the following:

- (a) The first eight (8) metres of air-conditioning duct from AHU outlet.
- (b) The return air transfer ducts in the AHU room wall, connecting the AHU room with the air-conditioned area.

The portion of supply air duct which is acoustically (internal) insulated need not be insulated thermally (external).

Insulation material shall be resin bonded rigid board fibreglass insulation of thickness 25 mm and density 48 kg / m<sup>3</sup> and faced with 26 G galvanised steel sheet (GSS) with minimum 40% open area.. The thermal conductivity (K) value shall not be more than 0.031 W/m K at 10 deg. C.

Mechanical fasteners shall be used to ensure adherence of duct insulation to surface of the ducts.

Chilled water piping and AHU and FCU condensate piping

All chilled water piping, hot water piping, condensate drain piping shall be insulated as indicated herein. Prior to application of insulation, all pipe work shall be cleaned on the surface with wire brush to remove dirt and dust.

The insulation for chilled water piping, pump, expansion tank etc., shall be carried out from Nitrile Rubber Insulation of Class "O" Closed Cell, 32 mm thick for pipes above 100 mm Dia & insulation of 25 mm thick for pipes below 100 mm Dia. The pipe insulation shall be covered with 26 Gauge Aluminium Cladding with superior workmanship.

The chilled water pipes in the plant and air handling unit rooms and as well as shaft risers and exposed roof, insulation shall be covered with 24G commercial grade aluminium sheet cladding. This basically includes entire chilled water piping network. The joints shall be formed with proper grooves and overlaps and secured in position with self tapping screws. For bends / elbows and such other fittings, the cladding shall be in multi-piece construction, the thickness of the sheet shall be 26G.

Arrows indicating direction of flow shall be clearly marked.

#### Chilled Water Pipe Insulation ( where above method is not feasible)

The insulation for chilled water piping shall be carried out from flexible pipe sections sheets of closed cell elastomeric insulation having a 'K' value of 0.037 W/mK at a mean temperature of 20°C and a minimum density of 55 Kg./Cubm.

The thickness of insulation shall be 19 mm upto 100 mm dia and 25 mm for above 100 mm dia pipes.

### **5.0 DRAIN PIPE INSULATION**

The material for insulation of drain pipes shall be pipe sections of flexible closed cell elastomeric insulation having a 'K' value of 0.037 W/mK at a mean temperature of 20°C and a minimum density of 55 Kg./cubm.

### **7.0 AHU ROOM INSULATION**

Acoustic insulation for the air handling unit rooms shall be done with 50 mm thick fibre glass as specified. Clean the surface to remove all dirt and dust. Apply two coats of hot air blown grade bitumen. Fix 50 x 50 mm GI channels on the wall / ceiling using rawl plugs to form a grid of 1000 mm x 500 mm. Friction fit the fibre glass in the 1m x 0.5 m. The fibre glass shall be wrapped inside RP tissue. Cover the insulation with 1 mm thick perforated aluminium sheet. The corners and junctions / terminations shall be covered with aluminium angles / flats.

### **8.0 PUMP / EQUIPMENT INSULATION**

The specification of insulation as per piping shall be applicable for this section also.

### **9.0 GENERAL REQUIREMENTS**

- 9.1 The application of insulation shall be made in a workmanlike manner. The insulation shall be applied to all surfaces when these are at ambient temperature. Ample provision shall be made for the maximum possible thermal movement and the insulation shall be applied in a manner which shall avoid breaking or telescoping due to alternate periods of contraction and expansion. A single layer of insulation shall not be more than 50 mm thick.
- 9.2 Insulation shall be applied after all leak tests on equipment and piping are over and the section of the plant has been specifically released by the CLIENT for such work.
- 9.3 All surfaces to be insulated shall be clean and dry before the insulation is applied. The surface shall be cleaned of all foreign material such as scale, dirt, rust and paint, by the use of steel wire brushes and steel scrapers, where necessary. One coat of primer paint shall be applied and allowed to dry before application of insulation.
- 9.4 Where multi layer insulation is provided, insulation adhesive shall be used between two layers.

9.5 For aluminium sheet finishing material provided, all joints shall be sealed with bitumastic paint and made effectively weather and waterproof.

9.7 Approval of the Engineer shall be obtained for samples of materials. Necessary test certificates shall be furnished to Engineer, before despatching any material to site.

9.8 The following information shall be furnished by contractor after award of contract.

- a) Detailed insulation application procedure with drawings
- b) Test certificates for insulation materials

**MODE OF MEASUREMENT:**

1.0 Representatives from the Contractor and Engineer shall conduct a joint inspection of the Equipments. All the discrepancies observed either incomplete works or defective work shall be clearly indicated in the joint inspection report. The mode of measurements given below is for the purpose of measurement and payment and the scope of works shall be as specified else where in the specification.

**1.1 Thermal insulation for Duct**

Area of duct insulation finished as per specification shall be calculated on the basis of finished duct area before insulation based on the approved drawing *I* as built drawing and paid per unit area.

**1.2 Acoustic insulation for Duct**

Area of acoustic insulation finished as per specification shall be calculated on the basis of finished duct area before insulation based on the approved drawing *I* as built drawing and paid per unit area.

**END OF SECTION**

## TESTING AND BALANCING

### GENERAL

- 1.1. All testing and balancing shall be made in the presence of the Consulting Engineer or his representative or other inspecting authority. Give not less than 5 days prior notice, in writing, to these parties before making any tests. Check list format has been furnished in every section for all air conditioning & ventilation equipment. The duly filled the check list has to be submitted to the consulting engineer before starting the testing & balancing.
- 1.2. Supply all necessary skilled labor, helpers, equipment and materials for tests, operating and adjusting the systems and for fully instructing the Employer or his representatives in the operation of the system.
- 1.3. Protect valves and equipment from damage during tests. Include connection to previously tested sections, if the systems are tested in sections.
- 1.4. Prior to the balancing procedure, operate all systems for at least 16 consecutive hours or longer if required, to prove satisfactory automatic operation. If systems shutdown is experienced for any reason, repeat and test until 16 consecutive hours are achieved. Operate equipment as recommended by the equipment manufacturers and in such a manner as to avoid damage to the work of other trades.
- 1.5. Submit to the Consulting Engineers for review a log of all tests made which shall include time, temperature, pressure and other readings necessary to indicate that the systems have been operated and tested as required by the Specification.
- 1.6. Upon completion of testing and balancing submit six (6) copies of the recorded test data for the Consulting Engineers evaluation and approval.
- 1.7. Flow quantities for Air side, Chilled and Condenser Water Systems shall be verified by the Consulting Engineers and Clients representatives before the report is submitted.

### 2.0. TESTING OF MEDIUM & LOW PRESSURE DUCTS

- 2.1. The Medium and Low Pressure ducts shall be tested for air leaks.

### 3.0 TESTING OF PIPING

- 3.1. All pressure systems specified to be tested using water as the test medium shall be first checked by pre-testing the test section, or system, with compressed air at 2.5kg/sq.cm for a period of 3 minutes. Correct all leaks disclosed by the pre-set before proceeding with the specified testing using water as the test medium.
- 3.2. Test all piping as noted below with no leaks or no loss of pressure. Repair or replace Defective piping until tests are accomplished successfully.

SYSTEM	TEST PRESSURE	TEST MEDIUM	TEST DURATION
Chilled water piping	7 kg/sq.cm	Water	24 hours
Condenser water piping - NA	6 kg/sq.cm	Water	24 hours
Condensate drains	3m hd	Water	24 hours



Refrigerant piping	21 kg/sq.cm	Dry Nitrogen	4 hours
--------------------	-------------	--------------	---------

3.2. For refrigerant piping, proceed further as follows:

- a. Test points of possible leakage to assure pressure tightness with halide testing device.
- b. Evacuate system to 100 microns using high vacuum pumps.
- c. With Vacuum pump stopped, system shall maintain vacuum for a period of 24 hours without losing vacuum of more than 50 microns.
- d. Refrigerant shall be charged only after the pressure tightness has been proven.

4.0. **TESTING OF ELECTRICAL WORK**

- 4.1. Supply necessary meters, instruments, temporary wiring and labor to perform all required tests and adjustment of equipment and wiring installed and connected under this Sub Contract, including the electrical equipment supplied by others to determine proper polarity, phasing, freedom from earth faults and shorts and the proper operation of equipment, meters relays etc.
- 4.2. All materials and manner of installation shall be in strict accordance with the applicable requirements of the local Authorities. The installation must pass all inspections, and will be subject to the approval of such authorities and the Engineer.
- 4.3. Wherever any codes, laws, etc., require any work to be tested or approved the Contractor shall provide proper facilities for access and for inspection, all at his own expense.
- 4.4. Tests shall be made for continuity and identification of each conductor. Both ends of a given conductor shall be identified alike. Before circuit terminal connections are made, continuity and identification shall be checked by means of a D.C. test device using a bell or buzzer or battery powered phone to ring out the wires.
- 4.5. All earth tests shall be made with 100 volt merger test-type instrument.
- 4.6. Test each circuit for grounds and shorts by means of a merger insulation testing instrument which shall impress a voltage of not less than 100 volts D.C. upon the circuit under test. Any circuit showing an insulation resistance less than the minimum values given in the Wiring Rules shall be investigated and weak points corrected. All circuits under merger insulation test shall be connected to the respective final terminals and switches or breaker, in the 'OFF' position.
- 4.7. Correct or replace any nominal current carrying circuit which is defective or earthed. Also correct all trouble encountered by test and set breakers and relays as directed so that equipment will be in proper operating condition, before being placed in service.
- 4.8. Following establishing procedure, equipment will be energised after certification that the installation is satisfactory .Final operational tests shall determine that the wiring connections are correct.

## 5.0 PRE BALANCE CHECKS AND START UP

5.1. The Air and Water Systems will be checked out at specified below, and started up prior to balancing.

- a) Complete "water pressure and duct pressure testing for leakage.
- b) Complete all 'Punch List' check items.
- c) Install all dampers and other balancing devices as called for in the construction documents and verify the same are properly installed, indexed and in good working order.
- d) Check all motor starters and verify that the heater sizing is correct, taking length of electrical feeders into consideration. Record amp readings on all motors.
- e) Check out and align all equipment drives.
- f) Set all fan sheaves to provide the indicated capacities at specified static pressures (RPM as specified).
- g) Set all manual balancing dampers, valves and balancing valves at 100% open position. Verify that all fire dampers are open.
- h) All adjustable pitch pulleys shall be removed from the motor shaft. The shaft and pulley threads shall be cleaned, lightly oiled, and pulley remounted, aligned and properly adjusted.
- i) Clean interior of all plenums, casings and ducts and install all filters before starting systems.
- j) Make sure all controls systems are calibrated and functioning properly.
- k) Place all systems in automatic operation.
- l) Operate systems for 16 consecutive hours without shutdown with all equipment in perfect working order. Manufacturers' representative must be present at initial start- up all equipment.
- m) Check fan and pump bearings for grease.
- n) Install clean prefilters and install high efficiency filters in all systems prior to starting air balance.
- o) Provide availability of personnel from all the related mechanical and Controls contractors during balancing.

## 6.0 TEST REPORTING FORMS

### 6.1. General

Test forms used for testing and balancing shall be set up to include the following information. Each sheet shall have job name and address, name of air conditioning sub-contractor, architect and engineer instruments used to perform tests, and name of test technician or test engineer. All forms shall be submitted in typewritten form. A minimum of 6 copies shall be submitted. Test sheets shall be similar to those shown in the section 4.13.

**6.2. Diffusers, Grilles and Registers -Test Sheets**

- a) Fan Systems and/or zone number
- b) Room number or area designation
- c) Outlet code number which shall correspond to code number of outlet on air balance code drawing.
- d) Size of Outlet -.
- e) Type of Outlet -.
- f) Manufacturer of Outlet
- g) Manufacturer's effective area for each size
- h) Required FPM and required CFM of each outlet
- j) Available FPM and CFM of each outlet

**6.3. Air Handling Equipment Test Sheets .**

The test sheets shall provide details of the following items: (Refer Checklist in AHU Spec. Section)

System Fan Number	Fan RPM
Fan Manufacturer	Size of Sheave Driver
Total CFM	Size of Sheave Driven
Return Air CFM	Belt sizes and number
Outside Air CFM	Motor Manufacturer
Total Static Pressure	Motor Size, Voltage
Suction Static Pressure	Phase & RPM KW
Discharge Static Pressure	Amperage Nameplate Rating
Coil Pressure Drop	Final Operating Amperage
Filter Pressure Drop	Overload Setting

**6.4. Exhaust Fans , Fresh Air Fans and Pressurization Fans Test Sheets**

The test sheets shall provide details of the following items:.

System Fan Number	Amperage Nameplate Rating
Fan Manufacturer	Final Operating Amperage
Size and Model	Fan RPM
Motor HP, Voltage & Phase	Total Static Pressure, Overload Setting

**6.5. Test, Code Drawings**

Each Report shall contain a single line drawing of air distribution system with fan system and zone number indicated. Each and every outlet, supply, and return shall be indicated on this drawing by a number corresponding to the number on the outlet test sheet, enabling the Engineer to locate each outlet for this drawing.

Drawing shall be clear and neat and shall list name of job and location of same.

**6.6. Temperature Test Sheets**

Temperature test sheets shall list both specified and test conditions in opposite columns.

Items listed on this sheet shall be as follows:

- a) Entering Air D.B. & W.B. Temperature
- b) Leaving Air D.B. & W.B. Temperature
- c) Entering Coil Water Temperature
- d) Leaving Coil Water Temperature
- e) Outside Air -D.B. & W.B. Temperature
- f) Room temperature reading to be checked against thermostat setting

**7.0. AIR SIDE TESTING AND BALANCING**

7.1. The Air System shall be tested and balanced as under:

- a) Test and adjust fan RPM to design requirements
- b) Test and record motor full load amperes.
- c) Make Pitot Tube traverse of main supply ducts and obtain design CFM at fans.
- d) Test and record system static pressures, suction discharge and total.
- e) Test and adjust system for design recirculated air.
- f) Test and adjust system for design outside air.
- g) Test and record entering air temperatures DB/WB.
- h) Test and record leaving air temperature DB/WB
- i) Adjust all main supply and return air ducts to proper design CFM.
- j) Adjust all zones to proper design CFM (supply and return).
- k) Test and adjust each diffuser, grille and register to within 10% of design requirements:
- l) Each grille, diffuser, register shall be identified as to location and area.
- m) Size, type and manufacturer of diffusers, grilles, registers, and all tested equipment shall be identified and listed. Manufacturer's ratings on all equipment shall be used to make required calculations.

- n) Readings and tests of diffusers, grilles, and registers shall include required velocity and test resultant velocity. Required CFM and test resultant CFM after adjustments.
- o) In co-operation with control manufacturer's representative, set adjustments of automatically operated dampers to operate as specified, indicated and/or noted.
- p) All diffusers, grilles, and registers shall be adjusted to minimise drafts in all areas.
- q) **As part of the work of this contract, the Contractor shall make any changes in the pulleys and belts for correct balance as required at no additional cost to Owner.**

## **8.0. WATER SYSTEMS TESTING AND BALANCING**

**HVAC contractor shall engage the services of balancing valve supplier to provide complete water side balancing.**

### **8.1. Pre Balancing Checks**

The Air Balancing should have been completed before the Water balancing begins. The Contractor is to ensure that the following works are completed prior to commencement of water balancing.

- a) Open all valves to full open position, including coil stop valves, bypass valves, and return line balancing cocks.
- b) Remove all strainers and clean the same and replace in system.
- c) Examine water in system and ensure water has been treated and is cleaned. This is to be verified by Owner's representative.
- d) Check pump rotation
- e) Check expansion tanks to determine they are not air bound and the system is completely full of water.
- f) Check all air vents at high points of water systems and determine all are installed and operated freely. Bleed any air out of systems.
- g) Set all temperature controls so all coils are calling for full cooling.
- h) Check operation of all automatic valves.
- i) Check and set operating temperatures of chillers to design requirements.

### **8.2. Initial Balancing**

- a) Set Chilled Water Pumps to proper gallons per minute delivery .
- b) Adjust water now of chilled water through chiller.

- c) Check leaving water temperatures and return water temperatures through chiller. Reset to correct design temperatures.
- d) Check water temperature at inlet side of Cooling coils. Note rise or drop of temperatures from source.
- e) Proceed to balance each chilled water coil.
- f) Upon completion of flow readings and adjustments at coils, set all memory stops and record all data.

### 8.3. **Final Balancing**

Upon completion of the above, the final balancing shall be completed as follows:

- a) After adjustments to coils are made, recheck settings at the pumps and chillers and read just if required.
- b) Install pressure gauges on coil, read pressure drop through coil at set flow rate on call for full cooling. Set Pressure drop across bypass valve to match coil full pressure drop. This prevents unbalanced flow conditions when coils are on full bypass.
- c) Set Chilled Water bypass to pressure differential specified on drawings.
- d) Record and check the following items at each cooling elements:

- Flow Rate
- Inlet Water Temperature
- Leaving Water Temperature
- Pressure drop of each coil
- Pressure drop across by pass valve
- Pump operating suction and discharge pressures and final total discharge head.
- List of all mechanical specifications of pumps
- Rated and actual running amperage and KW of Pump Motor

8.4. Upon completion of final balancing, all information shall be inserted of a sheet listing all items required by specifications and be included in complete test and balance report. All sheets shall be neatly typed.

8.5. Submit sample forms to the M & E Engineer for approval prior to starting balancing.

### 9.0. **TEST OF REFRIGERATION MACHINES**

9.1. The Refrigeration machines shall be tested by the equipment supplier for performance, and compliance with specification. The Contractor shall liaise and co-ordinate with the equipment supplier to carry out the tests.

9.2. The test shall consist of operating the equipment at prevailing conditions and recording chilled water temperature and condenser water in US GPM and power input.

9.3. Calculated refrigeration tonnage shall be compared with predicted full and part load curves provided by the manufacturer. These curves shall indicate power input plotted against tons of refrigeration output at condenser water temperature ranging from 32°C and 0.5°C intervals.

- 9.4. Chilled Water and Condenser Water quantities shall have been determined from measurements of USGPM handled by water pumps.
- 9.5. Test shall consist of a minimum continuous run of 6 hours with 24 readings made for each item above, unless continuously recordings instruments are used.
- 9.6. Supply calibrated instruments for testing. Instruments shall be calibrated immediately prior to tests and after completion of tests.
- 9.7. The noise level of the equipment shall be measured and recorded.

**END OF SECTION**

## HVAC ELECTRICAL WORKS

### 1.0 SCOPE

HVAC contractor shall refer to Electrical Schematic drawings to understand his exact scope of Electrical works for HVAC works. HVAC Contractor scope of Electrical works shall start from feeders provided by the Electrical Contractor near each Panel.

#### **CHILLER UNITS**

##### HVAC ELECTRICAL CONTRACTOR

Supply, Installation Testing and commissioning of Chiller MCC with Air Circuit Breaker (ACB) as the feeder with Motor Protection relay.

Supply, Laying of power cables with necessary cable support system up to the Chiller starter panel

Supply and Installation of earthing system upto Chiller MCC

Supply, Installation Testing and commissioning of chillers with Starters

Supply, Laying, Testing and commissioning of power and control cables with necessary termination from Chiller starter panel to Chiller Motors

Supply, Laying, Testing and commissioning of control cables with necessary termination from Motorised valve actuator to Starter

The chiller starter panel shall be able to accommodate the cable sizes as indicated in the single line diagram.

#### **AHU**

##### HVAC ELECTRICAL CONTRACTOR

Supply, Installation Testing and commissioning of AHU MCC with MCB feeder.

AHU local starter panel shall be supplied and installed in AHU room

Supply, Laying of cables with necessary cable support system up to the AHU starters panel

Supply and Installation of earthing system up to starter panel

Supply, Laying, Installation Testing and commissioning of power and control cables with termination and necessary cable tray support system from AHU starters panel to AHU Motors, including control cables for motorised valve actuators and limit switch.

#### **CHILLED WATER PUMP MCC**

##### HVAC ELECTRICAL CONTRACTOR

Supply and Installation of Chilled Water pump MCC with starters

Supply and Installation of Local Push button station (LPB) with control cable

Supply, Laying of cables with necessary cable support system up to the Chilled water pump MCC

Supply, Laying, Testing and commissioning of power and control cables with necessary termination from Chilled water pump MCC up to the motors with necessary termination and cable tray support system

Supply and Installation of earthing system for MCC



Supply and Installation of Single Phase power for Fan coil units  
Supply, Laying of power cables with necessary cable support system up to the FCU units.  
Supply and Installation of earthing system for MCC panel on the roof.

### **MECHANICAL VENTILATION FANS:**

#### **HVAC ELECTRICAL CONTRACTOR**

Supply and Installation of MCC with starters.  
Supply, Laying, Installation Testing and commissioning of power and control cables for the regulators with necessary termination from MCC to FCU units.  
Supply, Laying, Installation Testing and commissioning of power and control cables for the Fans with necessary termination from Starters to Isolators and then to fan motors.  
Supply and Installation of earthing system for the MCC.

## **2.0 CODES AND STANDARDS**

Unless otherwise specified herein, all electrical equipment, cabling and method of installation shall comply with Indian Electricity Rules, Tariff Advisory Committee Regulations on Building Safety, National Building Code, National Electricity Code and other relevant Indian Standard Specifications by the Bureau of Indian Standards.

## **3.0 GENERAL REQUIREMENTS**

3.1 The CONTRACTOR shall consider harmonics suppression equipment and shall limit the values as follows :

- (a) Total Harmonic Voltage Distortion (THVDF) : 3%
- (b) Single Harmonic Voltage Distortion (SHVDF) : 2%
- (c) Even Harmonics : 1%

3.2 Smoke detector shall be installed in the return air path in the AHU room and when this picks up, the AHU motor shall trip automatically.

3.3.1 During fire in any floor Main Incomer of AHU MCC shall trip and the pressurisation fans for smoke free lobby and stair case lift lobby shall be energised. Necessary contacts/signals shall be obtained from the fire alarm system and incorporated in the AHU panel.

## **4.0 MOTORS**

4.1 All motors shall conform to the requirements of IS:325-1996.  
The motors to be of EEF 1 Type

- 4.2 All motors shall be specifically designed for 50HZ operation at 240 volts for single phase and 415 volts for three phase and with Class B insulation. Degree of protection shall be IP 54 for indoor and IP55 of outdoor installation.
- 4.3 Fractional horsepower motors shall be single phase squirrel cage capacitor start, induction run.
- 4.4 All motors up to and 7.5 HP shall be suitable for DOL starting
- 4.5 All motors above 7.5 HP shall be with Star Delta starting  
The contractor shall submit characteristics such as starting KVA and power factor , recommended star-Delta transition period and full load starting and running currents for all motors.

## **5.0 CABLES**

- 5.1 Cables shall be 1100V grade, aluminium/Copper conductor, PVC insulated, PVC sheathed conforming to IS:1554, 1988 and specification.
- 5.2 Cable sizes shall be selected to ensure that they have adequate current carrying capacity and to limit the voltage drop during running to 5% and voltage dip during starting of the motor to 10% Also adequate derating factors shall be considered.
- 5.3 Cabling to the equipment operating during fire condition for. eg. pressurisation fans for smoke free lobbies and lift lobbies shall be connected to the Main LV switchboard and shall be by FRLS PVC outer sheathed cables. the properties of the FRLS PVC compound shall be as given in the cable specification. The cables shall be laid in cable trays along the electrical riser and either in cable trays or in conduits upto the equipment. The conduits shall be of not less than 20 mm dia. The conduits shall be of medium duty PVC and heavy duty PVC when run concealed and exposed respectively. The installation of cable trays and conduits shall be as per approved drawings.

## **6.0 EARTHING**

- 6.1 All equipments of the A/C and Mechanical ventilation system like motors, cable trays, junction boxes, distribution boards, etc. Shall be connected to the nearest building earthing conductor by conductor sizes for chillers Motors 50X6 GI flat, Cooling tower /AHU/pumps Condenser Pump shall be with 25x6 flat. FCU by 4sqmm Cu. Wire.

## **7.0 BAS INTERLOCKS**

Potential free contacts and inputs as listed in the BAS input/output table given elsewhere shall be made available .

## **8.0 TESTING**

Type test certificates of equipments supplied under this contract shall be furnished for review. In the absence of the same, the CONTRACTOR shall carry out the type tests without any extra cost. Major Electrical items shall be offered for routine tests inspection at works. Sample pieces of all important items shall be offered for approval at site and kept at sample room to verify / cross check the future supplies.

## **9.0 WIRING DIAGRAM**

The Contractor shall provide in the plant room a complete "as installed" wiring diagram identifying all numbered control circuits and all colour codings mounted in a glazed frame.

## **10.0 DRAWINGS**

The CONTRACTOR shall submit generally applicable switchgear layout along with the Tender and GA, scheme drawings of switchgear, control panels and layout requirements for review prior to fabrication.

**END OF SECTION**

## **SPECIAL CONDITIONS FOR ERECTION CONTRACT**

### **1.0 PROGRAMME :**

The Contractor shall prepare, in consultation with the Owner, a programme for the completion of the work, which may be carried by agreement in writing between the Owner and the Contractor. The contractor shall maintain progress throughout the contract period so as no to delay other traders or Contractors.

### **2.0 DIMENSIONS :**

Dimensions are to be adhered to as stated in the specifications or as figured on the drawings. Large scale details and written particulars furnished by the Owner are to be used in preference to small scale drawings and are to be strictly followed as to their true intent and meaning. However, Contractor should check physical dimensions before proceeding with any work. Any discrepancies between drawings and physical dimensions to be brought to the notice of Owner's Site Engineer.

### **3.0 INCLEMENT WEATHER :**

The Contractor shall take note of the climatic conditions as pertaining to the areas in which the works are located and shall be deemed to have included all costs for protecting from injury by weather all works and materials that may be so affected.

### **4.0 FREE ISSUE OF MATERIALS :**

All items of equipment as accepted by the Contractor from any other places shall be erected by the Contractor without any damage.

### **5.0 SUPERVISION OF WORK :**

The Owner reserves the right to interview the Contractor's nominated site representative and skilled tradesmen either prior to the award of the contract or prior to commencing work on site. Should the nominated representative not be considered suitable, the Contractor shall provide further representatives and skilled tradesmen for interview until such time as the Owner is satisfied that a competent man will

be appointed. That the Owner may have approved the appointment will in no way relieve the Contractor of any responsibility under the terms of contract. All costs including travelling expenses etc., incurred by the Contractor in following the above procedure shall be born by the Contractor.

#### 6.0 LABOUR DISPUTE :

The Contractor shall keep the Owner fully informed on all matters concerning labour disputes, strikes, etc., involving the Contractor's labour force and the effects on the progress of work. The Owner shall be kept fully informed of the course of action proposed to remove or alleviate the cause of the dispute.

#### 7.0 COMPLETION :

7.1 Completion shall be as defined in the Time Schedule.

- a. Following completion, the Contractor shall have the rights of access to all parts of the plant at all reasonable time in so far as operation of the plant by the Owner permits for the purpose of completing outstanding work and inspection and making tests and modifications to fulfill obligations under the contract. Such access shall be at the Contractor's risk. The Contractor shall not bring visitors to the plants as potential customers or for other purpose without prior agreement in writing of the Owner on each occasion.

#### 8.0 RESPONSIBILITIES OF OWNER :

8.1 Provide an adequate area adjacent to the site to accommodate the Contractor's temporary facilities.

8.2 Provide and maintain suitable access to the job sites for the Contractor's personnel, equipment and materials.

#### 9.0 POSSESSION OF SITE :

The Owner shall give the Contractor facilities for carrying out the works on the site from the date set for the beginning of work on the site. Access to a possession of the site shall not be exclusive to the Contractor. The Contractor shall give to any other Sub-Contractor every reasonable facility for the execution of concurrent work.

10.0 The Contractor will arrange to carry out all necessary work associated with holes for pipes through brick work, concrete or steel work and for drilling all holes for fixings.

#### 11.0 PHOTOGRAPHS :

The Contractor shall not take photographs of any part of the works without the written permission of the Owner.

12.0 CONSUMABLES :

The Contractor shall use all the consumables but not limited to industrial gas, argon gas, oil & grease, jointing compounds, PTFE tape, emery tape, cleaning rags, saw blades, welding filter wires and electrodes etc.

13.0 CONTRACTORS CONTROL :

It is the intention of the Owner to monitor and control progress of the works and authorise interim payments. The Owner will expect the full co-operation of the Contractor in the preparation of the valuations and reporting systems and the contractor's price is inclusive of all such costs.

14.0 OTHER CONTRACTORS :

The Contractor shall take fully into account the effect of other concurrent work being carried out in the area or on the same site by other Contractors on the site will be expected from the contractors to ensure that the works are completed in a trouble free, efficient and neat manner.

### **ADDITIONAL CONDITIONS :-**

1. Please note all required tools tackles, ladders, scaffolding etc. for execution / completion of site shall be organised by the successful contractor for carrying out their work.
2. Main incoming supply 3phase/ 1phase, 415V/230V, 50hz, will be provided by the buyer at one point. The successful contractor shall carry out further distribution between the electrical panel and equipments with necessary cabling.
3. Drain piping shall be properly laid and connected at the drain point as per specifications and as shown by the consulting engineers as per site condition.
4. The buyer shall carry out all required major civil work like opening in walls & making good of all holes. All fire seals for the openings shall be carried out by the successful contractor of F-90 Class
5. All required labour and material handling equipment required for execution at site shall be organised by the successful contractor for carrying out their work.
6. Please note all the labour engaged at site for execution of work shall be covered under ESI/PF as per the government rules, and all necessary details shall be submitted to the client before starting the execution work at site.
7. The contractor shall have a comprehensive all risk (CAR) & Workman Compensation (WC) of the full amount of the contract value.
8. For carrying out extra work or if the contractor decides to work after duty hours, special permission shall be taken from the authorities before doing so.
9. All labour employed at site shall use safety belts, safety shoes, safety gloves, safety helmet, safety goggles etc., If any of the contractor found not adhering to the safety precautions, his work at site would be stopped immediately & a penalty of Rs.1,000/- per day will be charged to him. However this delay should not reflect in the overall project delay, as it might lead to penalty as per the LD clause. Client/owner shall not be held responsible for any accidents / Mishap that may happen on site due to negligence / overlook of safety precautions.
10. **Tenders received through Fax / Email / Telegraphic / Telex will not be considered.**
11. The tenders must be clearly written or typed without any cancellations/ Corrections or Over writing.
  - a) Tenders, which are submitted without following the Two-Bid offer system, will summarily be rejected.
  - b) Unsigned Tender Will also be rejected.
  - c) Part and incomplete tender are liable to be rejected.

- d) Commercial bid should be submitted in the Soft Copy in the CD.
12. The tender will be received in the institute till **03 Oct' 2011 up to 12.00 Hrs.** and shall be opened on 03 Octy'2011 **at 15:30 hrs.** in the presence of the bidders or their authorized agent who wish to be present.
13. IITM will not be responsible :
- A. For delayed /late quotation submitted /sent by post / Courier.
  - B. For submission / delivery of quotations at wrong places other than the office of Director,
15. The technical bid should accompany with complete specification, Manufacture's name address and relevant Technical Literature /Brochures with warranty terms.
16. **Delivery Period** – As the time is the essence of the contract, delivery period (Two month or earlier) mentioned in the work order should be strictly adhered.
17. Kindly attached a of copy of your latest DGS & D, New Delhi registration certificate under the compulsory scheme of Ministry of Finance regarding the registration of Indian Agent of foreign supplier wherever it is applicable.
- A. The tenderer is required to furnish the Permanent Account Number (PAN) Allotted by the Income tax Department. If registered with the National Small Industries Corporation, the registration number, purpose of registration and the validity period of registration etc. Should also be provided in the Technical bid for Indian Agents.
  - B. A copy of latest Income tax Clearance Certificate from Income tax Department (INDIA) for Indian Agents.
18. Tender must clearly indicate the feature offered unit price, VAT , transport ,transit insurance, installation Charges. Institute cannot furnish any concessional certificate for exemption of reduction in VAT or other duty/tax. The vendor should mentioned the price of the equipment and the duties / taxes to be paid such as customs duty /excise duty /VAT taxes etc separately.
19. The prices quoted should be firm and irrevocable and not subject to any change whatsoever, even due to increase in cost of raw material component and fluctuation in the foreign exchange rates and excise duty.
20. **WARRANTY/GUANRANTEE:-** The equipment is to be guaranteed for trouble free performance for a minimum period of **TWO YEAR** after installation. Supplier shall finally warrant that all the stores, equipment and component and component supplied under the ORDER shall be new and of the first quality according to the specification and shall be free from the defects.(even concealed fault, deficiency in the design material and workmanship). The defects, if any , during the guarantee period are to be rectified free of charge by arranging free replacement wherever necessary. Further. the technical specification and requirements may also be verified and quoted accordingly.
21. Please mentioned that during warranty period who will maintain system/equipment. Indicate the name of the firm, address, contact person, phone no. And tax no. Etc. In your technical bid.

22. After successful installation what will be the minimum down time of equipment/instrument in case of breakdown. If the identified firm or person fails to put the system into working condition what is the further alternative course of action suggested by you to adhere to minimum down time.

23. Warranty period will stand extended for a period of total down time of the equipment.

24. After warranty period (post warranty) who will maintain system indicate the name of firm, address, contact person, phone no. etc. in the your technical bid.

25. No sub-contracting will be allowed for installation or maintaining system..during of after warranty period.

26. Discount offered should be mentioned clearly in the commercial bid.

27. A) The earnest Monet deposit of Rs 2,50,000/- (**Rs Two Lakhs Fifty thousand Only**) must be paid / sent along with your technical bid in the form of a Demand draft. Bank guarantee (preferably from a nationalised Bank only) drawn in the favour of The Director, Otherwise your technical & financial bids will not be considered at all. The Earnest Money of successful bidder will be return only after installation, commissioning, satisfactory demonstration and on acceptance of the system by user engineer as per the terms of our work order. If any the successful bidder fails to fulfil the contractual obligation before the due date, he will forfeit the EMD.

B) The Earnest money of Unsuccessful bidder whose technical bid has not been found suitable will be return within 15 days after receipt of Technical Committee recommendations.

C) Though EMD has to be submitted by Demand Draft, Banker's Cheque or Bank Guarantee, we prefer to have Bank Guarantee for easy return to the bidder once a decision is taken by (Specimen of bank Guarantee is enclosed at Annexure 'A')

D) Tenderers not accomplished with Demand Draft / bank Guarantee towards "Earnest Money Deposit" will summarily be rejected.

28. Please indicate pages nos on your quotation eg. If the quotation is containing 25 pages, please indicate as 1/25, 2/25, 3/25 -----25/25.

28. Firms which have already supplied similar equipment to and have not completed required **installation / Commissioning / after sales service / warranty replacement etc. Such firms offers will not considered for further evaluation and no enquiries thereafter will be entertained.**

29. **In the event the manufacture / Supplier proposes for the amalgamation, acquisition or sale of its business to any firm during the contract period, the Buyer/Successor of the Principle Company are liable for execution of the contract and also fulfilment of the contractual obligation i.e. supply installation, commissioning ,warranty, maintenance /replacement of spares accessories etc. With the same cost / ordered value while submitting your bid, you may confirm this condition.**



30. Conditional offer will not be considered.

31. All dispute are subject to exclusive jurisdiction of Competent Court and Forum in Pune , India only.

32. The Director, Indian Institute Of Tropical Meteorology , Pune 411008 , India reserves the right to accepts any tender in full or Part or to reject the lowest or any or all tenders without assigning any reason.

**33. Corrupt Or Fraudulent Practice :-**

A) IITM requires that the Bidder /Suppliers / Contractors under this tender ,observed the highest standard of ics during the procurement and execution of such contract. In purpose of this policy,

I. Defines for the purpose of this provision, the terms set forth as follows:

a) “Corrupt practice” means the offering, giving, receiving or soliciting of anything of the value to influence the action of the public official in the procurement process or in contract execution; and

b) “fraudulent practice” means a misrepresentation of facts in the order to influence a procurement ocess or execution of a contract to the detriment of and includes collusive practice among bidder (prior to or after bid submission) designed to establish bid price at artificial non-competitive level and to deprive of the benefits of the free and open competition;

II. Will reject a proposal for award if it determines that bidder recommended for award has engaged in corrupt of fraudulent practice in competing for the contact in question;

B) will declare a firm ineligible, either indefinitely or for stated period of time, to be awarded a Contract if it at any time determines that the firm has engaged in a corrupt and fraudulent practice in Competing, Or in execution, a contract.

## **STATUTORY OBLIGATIONS**

The Contractor shall observe that the working as intended in the document is adhered to or conforming to and NOT NECESSARILY BE LIMITED to the following standard regulations :

- i) FACTORIES ACT as amended (latest)
- ii) Explosive Act.
- iii) Safety regulations laid down by Central Government and state Authorities and the Owner.
- iv) Indian Electricity Rules and Regulations.
- v) Standard Codes for Pressure Piping (ASA B31.3.1973)
- vi) Statutory requirements for inspection and test of all lifting appliances and auxiliary lifting gear.
- vii) Labour Act.
- viii) Local-By-Laws.
- ix) Regulations laid by the Fire Safety Committee, Insurance Association of India.

1.2 In case of conflict between these specifications and the standards which come into force shall be considered as included and applicable to the work covered here and elsewhere in this documents.

**LIST OF APPROVED MAKE:**

Sr.No.	Component	Approved Make
1	Motors	Siemens/crompton//Bharat bijlee
2	Insulation	
	A. – Fibreglass	Up Twiga / Khimco / Owens / Eqv.
	B. - Nitrie Rubber	Armaflex
3	Grilles / Diffusers	Cosmos / Caryaire (Ravistar) / Air Products / Air cosns air/ Treat Air
5	Pre-Filters	Pyramid / Dyna / Airtech / Eqv.
6	Ducting Sheet	TATA / Jindal
7	Ducting	Nutech / Alfa / Radiant
8	Pipe Supports	Energia / Intellotec./Amtech
9	Chillers	Uniflair/ McQuay/Carrier/York/Kirloskar
10	Pumps	Grundfos/Kirloskar/ATT/Matther & Plat.
11	AHU	Treat Air / VTS Group / Nutech / Carryair
12	Chilled Water cassettes	GD Media/Carrier/Daikin
13	Valves	Audco/Kirloskar/Inter valve
14	Pressure Switch	Hoonywell/Indfoss/Swiezer
15	Dial type Pressure Guage	Wika
16	Dial type Thermometer	Wika
17	PVC Drain Pipe	Filolex/Reliance
18	Fire Dampers	Cosmos/Ravistar /Airmaster
19	Supply/Ventilation Fans	Kruger/Nicotra
20	Split AC	Daikin/LG/Carrier/Toshiba
21	Piping Plastic	George Fischer/ Prime / Reliance.
22	Butterfly Valve	Kirloskar / Audco / Intervalve
23	Expansion rubber bellows	Cori / Eq
24	Ball Valves	Audco / Kirloskar
25	Auto Balancing valve	Tour Anderson / Watts
26	Automatic Air vents	Anergy
27	Duct inline fans	Nutech / Nicotra / Krugger
28	Check Valves	Intervalve
29	Y Strainer	Sant
30	Air Seperator	Anergy / Energia
31	Power Cable	Polycab / Finolex/KEI
32	Control Cable	Polycab / Finolex / KEI
33	Electrical Components	Siemens / Schneider
34	(Switches, Hrc Fuses Etc.)	
35	Cricuit Breakers	Siemens / Schneider
36	L.T. Breaker	Siemens / Schneider
37	Switch Fuse Unit	Siemens / Schneider
38	MCCB	Siemens / Schneider
39	MCB	Siemens / Schneider
40	Push Buttons	Siemens / Schneider
41	Indicator Lamp	Siemens / Schneider
42	Ammeter ( Digital Type )	Siemens / Schneider
43	Voltmeter ( Digital Type )	Siemens / Schneider

44	Connector	Siemens / Schneider
45	Selector Switch	Siemens / Schneider
46	Electric Wire	Siemens / Schneider
47	Cable Gland	Siemens / Schneider
48	Lugs & Sockets	Siemens / Schneider
49	PVC Tape	Steel Grip / Bhore / Eqv.
50	Screw	Nettlefold / Gkw / Eqv.
51	Bimetallic Clamps & Connection	Smoutan / PEC / Milind / Eqv.

----- END OF SECTION -----

## Air Handling Unit Schedule

Sr.No.	Area	AHU-Tag	Total Cooling Capacity	Total Air Flow	Fresh Air	Return Air	Air Inlet Condition		Air Out Conditions		Chilled Water Temp.		Chilled Water Flow	E.S.P.	Power		
			TR	CFM	CFM	CFM	DBT Deg F	WBT Deg F	DBT Deg F	WBT Deg F	In Deg F	Out Deg F	GPM	mm of WC	KW	Ph	Hz
1	Auditorium Hall-1	AHU-7	22.00	8500	1175	7325	78.15	66.07	57	56.6	44.6	53.6	56.93	50	3.07	3	50
2	Auditorium Hall-2	AHU-8	22.00	8500	1175	7325	78.15	66.07	57	56.6	44.6	53.6	56.93	50	3.07	3	50
3	Cafeteria-1	AHU-1	12.00	5000	500	4500	77.00	69.37	57	56.6	44.6	53.6	31.05	50	1.81	3	50
4	Cafeteria-2	AHU-3	12.00	5100	420	4680	76.47	70.69	57	56.6	44.6	53.6	31.05	50	1.84	3	50
5	Cafeteria-3	AHU-2	12.00	5000	500	4500	77.00	69.37	57	56.6	44.6	53.6	31.05	50	1.81	3	50
6	Cafeteria-4	AHU-4	12.00	5100	420	4680	76.47	70.69	57	56.6	44.6	53.6	31.05	50	1.84	3	50
7	Lect Hall Lobby-1	AHU-5	4.00	1700	150	1550	76.65	72.14	57	56.6	44.6	53.6	10.35	50	0.61	3	50
8	Lect Hall Lobby-2	AHU-6	4.00	1700	150	1550	77	72	57	56.6	44.6	53.6	10.35	50	0.61	3	50

## Fresh Air Handling Unit Schedule

Sr.No.	Floor	FAHU Tag	Zone	Total Air Flow	Total Cooling Capacity	Air Inlet Condition		Air Out Conditions		Chilled Water Temp.		Chilled Water Flow	E.S.P.	Power		
				CFM	TR	DBT Deg F	WBT Deg F	DBT Deg F	WBT Deg F	In Deg F	Out Deg F	GPM	mm of WC	KW	Ph	Hz
1	Basement	AHU-9	Dining	1750.00	8.00	104	76	57	56.6	44.6	53.6	20.70258	25	0.632	1	50
2		AHU-10	Dining	1750.00	8.00	104	76	57	56.6	44.6	53.6	20.70258	25	0.632	1	50

## 4 Way Cassette Unit Schedule

Sr.No.	Floor	Area Served	Total Air Flow	Air Flow Per FCU	Quantity	Total cooling Capacity	Cooling Capacity Per FCU	Air Inlet Condition		Air Out Conditions		Chilled Water Temp.		Total Chilled Water Flow	Chilled Water Flow Per FCU	Power		
			CFM	CFM		TR	TR	DBT	WBT	DBT	WBT	In Deg F	out Deg F	GPM	GPM	W	Ph	Hz
1	FF	Lecture Hall-1	3450	1200	4	12.00	3.00	74	63	57	56.6	44.6	53.6	31.90	7.80	215	1	50
2		Lecture Hall-2	3450	1200	4	12.00	3.00	74	63	57	56.6	44.6	53.6	31.90	7.80	215	1	50
3	Basement	Dining Hall	10200	800	14	28.00	2.00	74	63	57	56.6	44.6	53.6	74.50	5.32	180	1	50

## Air Cooled Chillers Schedule

Sr.No.	Total Cooling Capacity	Cooling Capacity Each	Quantity	Out Side Air Conditions Condition		Chilled Water Temp.		Chilled Water Flow	Power (Each)		
				DBT Deg F	WBT Deg F	In Deg F	Out Deg F		GPM	KW	Ph
1	150	75	2	104	75	44.6	53.6	194.09	202.50	3	50



## Air Cooled Chillers Schedule

Sr.No.	Total Cooling Capacity	Cooling Capacity Each	Quantity	Out Side Air Conditions Condition		Chilled Water Temp.		Chilled Water Flow	Power (Each)		
				DBT Deg F	WBT Deg F	In Deg F	Out Deg F		GPM	KW	Ph
1	150	75	2	104	75	44.6	53.6	194.09	202.50	3	50

## Air Cooled Chillers Schedule

Sr.No.	Total Cooling Capacity	Cooling Capacity Each	Quantity	Out Side Air Conditions Condition		Chilled Water Temp.		Chilled Water Flow	Power (Each)		
				DBT Deg F	WBT Deg F	In Deg F	Out Deg F		GPM	KW	Ph
1	150	75	2	104	75	44.6	53.6	194.09	202.50	3	50

**Chilled Water Pump Schedule**

Sr.No.	Pump Tag	Quantity	Chilled Water Flow Each	Total Head	Chilled Water Temp.	Power (Each)		
						KW	Ph	Hz
		Nos	GPM	Mtrs	In Deg F			
1	CHW-01	2W+1 SB	200	30	44.6	TBA	3	50

## Provision of HVAC System For Multi Training Facility Building for Indian Institute Of Tropical Meteorology at Pashan, Pune.

BILL OF QUANTITY							
Sl.No	Description of Work	Unit	Qty	Rate (Rs.)		Total (Rs)	
				Supply	Installation	Supply	Installation
	<b>CHILLERS</b>						
1	Supply, installation, testing & commissioning of 75 TR 'SCREW' type Air-cooled liquid chillers, complete with spring loaded anti vibration mounts, With first charge of Refrigerant Gas, Lubricating oil etc., for the following operating conditions. The chillers shall be complete with screw compressors, Shell & Tube Air cooled condensers, Flooded/DX evaporator, Drive Motor, Control panel etc., Star delta Starter , stepless capacity control, etc.,as per specifications mentioned in the technical specification sheet. The Chiller shall be capable of operating in open ambient temperature of local ambient of Pune City, and shall use R-134 a / R-410C Refrigerant. The Chiller should be installed on Spring Mounted Antivibration mounts.	Nos	2			0	0
1.1.	<b>Cooling Capacity (75 TR x 2 Nos)</b>						
	Chiller Flow rate : 200 US GPM Chiller tubes to be designed for the above flow rate.						
	Fouling Factor : 0.0005 ~ 0.0001						
	IKW/TR : 1.25 ~ 1.36 Kw/TR						
	EWT : 12.00 Deg C						
	LWT : 7.00 °C						
	<b>TOTAL VALUE FOR CHILLERS</b>					<b>0</b>	<b>0</b>
2	<b>CENTRIFUGAL PUMPS</b>						
2.1	Chilled water pump skid for primary pumping for Aircooled Chillers complete with Monoblock Pumps with 'SS' impeller and VFD drive (2 working + 1 standby) module , each capable of delivering as per spec below, Y-Strainers, Butterfly Valves, Non-Return Valve of required sizes, Rubber Expansion Bellows . The entire skid shall be mounted on a 'C' channel base frame with vibration isolators. The entire skid shall be coated with Zinc-cromate primer coating and then painted with enamel paint.The entire skid will be treated as a one unit						
	Pump design parameters to be designed as follows.						
	Primary chilled water pump module						
	Flow rate : 200 US GPM@ 30 Mtr head required as per site condition. The pump should be provided with mechanical seal.(2W+1SB) Module	Nos	1			0	0
	<b>TOTAL VALUE FOR PUMPS</b>					<b>0</b>	<b>0</b>
3	<b>AIR HANDLING UNITS</b>						
3.1	Double Skin ceiling suspended AHU With 50 mm Sandwiched PUF Insulation, backward Curved Fan Section with Motor, Coil, Drive Package, Filter, Limit Switch, Emergency Light, SS Drain Pan with drain connection, Fresh air Mixing chamber,Inspection door with guard,Necessary valve station campraises of 4 Nos Butterfly Valve,3 way motorised valve with Actuators,Y-Stainer and the entire skid shall be coated with Zinc-cromate primer coating and then painted with enamel paint of followings capacities etc.						
3.1.1	5000 CFM, 12TR capacity with min 20 mm WC-ESP for cafeteria on GF (AHU-1 & 2)	Nos	2			0	0
3.1.2	5100 CFM, 12TR capacity with min 20 mm WC-ESP for cafeteria on GF (AHU-3 & 4)	Nos	2			0	0
3.1.3	1700 CFM, 4TR capacity with min 20 mm WC-ESP for Lobby on FF (AHU-5 & 6)	Nos	2			0	0
3.1.4	1700 CFM ,8 TR Fresh Air Handling Unit. With 20 mm WC-ESP for Dining Area (AHU 9 & 10)	Nos	2			0	0
3.2	Double Skin Floor Mounted AHU With 50 mm Sandwiched PUF Insulation, Forward/backward Curved Fan Section with Motor, Coil, Drive Package, Filter, Limit Switch, Emergency Light, SS Drain Pan with connection,Fresh air Mixing chamber,Inspection door with guard, Necessary valve station campraises of 4 Nos Butterfly Valve,3 way motorised valve with Actuators,Y-Stainer and the entire skid shall be coated with Zinc-cromate primer coating and then painted with enamel paint of followings capacities etc.as per specifications mentioned in technical data sheet etc.as per specifications mentioned in technical data sheet						
3.2.1	8500 CFM, 22TR capacity with min 30 mm WC-ESP for Auditorium Hall (AHU-7) & (AHU-8)	Nos	2			0	0
	<b>TOTAL VALUE FOR AHUs</b>					<b>0</b>	<b>0</b>

Sl.No	Description of Work	Unit	Qty	Rate (Rs.)		Total (Rs)	
				Supply	Installation	Supply	Installation
4	<b>SECTION - Chilled Water Cassette</b>						
4.1	4 Way Chilled Water Cassette type Fan Coil unit with Fan, Motor with three speed control, Coil ,additional insulated drip tray as per the specifications mentioned in technical data sheet. It Should have a cordless remote control and drain pump to remove condensate drain. Necessary valve station campraises of 4 Nos Ball Valve, 3 way motorised valve with Actuators and auto balancing valve, Y-Stainer with SS drain pan with insulation. for following capacities etc.as per specifications mentioned in technical data sheet						
4.1.1	3 TR COOLING Capacity 1200 CFM	Nos	8			0	0
4.1.2	2.0 TR COOLING Capacity 800 CFM	Nos	14			0	0
	<b>TOTAL VALUE FOR CHILLED WATER CASSETTE</b>					<b>0</b>	<b>0</b>
5	<b>CHILLED WATER SYSTEM</b>						
5.1	Supply, installation, testing & commissioning of PPR piping of PN-10 with all necessary Fitting,supportsas per site condition and 19 thick Closed cell rubber nitrile of Class "O".						
5.1.1	125 mm Dia	RMT	75			0	0
5.1.2	110 mm Dia	RMT	100			0	0
5.1.3	90 mm Dia	RMT	100			0	0
5.1.4	75 mm Dia	RMT	130			0	0
5.1.5	63 mm Dia	RMT	50			0	0
5.1.7	40 mm Dia	RMT	65			0	0
5.1.8	32mm Dia	RMT	50			0	0
6	Supply, installation, testing & commissioning of valves& Gauges with insulation of 32 MM thick Armaflex covered with 26 Gauge Aluminium Cladding.						
	<b>Equipment / Chiller Unit Side</b>						
6.1	Butterfly valves with matching flanges, properly insulated with 26G Al. cladding.						
6.1.1	80 mm Dia	Nos	2			0	0
6.1.2	125 mm Dia	Nos	4			0	0
6.2	Flow Switch suitable for 100mm Dia Pipe	Nos	2			0	0
6.3	Diferential pressure switch suitable for 100 mm Dia Pipe	Nos	6			0	0
6.4	100 mm dia dial type pressure gages with needle valve & as per specifications mentioned in technical data sheet	Nos	24			0	0
6.5	Dial type industrial type imported thermometer with 100mm dia dial & as per specifications mentioned in technical data sheet	Nos	24			0	0
6.6	Chiller Inlet & Outlet Rubber Expansion Bellows - 100 mm Dia	Nos	4			0	0
6.7	Ball Valve for drain & air removal 25 mm size	Nos	6			0	0
6.8	Flanged Balancing Valve With Pressure Test Cocks Only In S.S. 410 Disc & EPDM Sealing Disc						
6.8.1	100 mm Dia	Nos	1			0	0
6.8.2	80 mm Dia	Nos	4			0	0
6.8.3	65 mm Dia	Nos	6			0	0
6.8.4	50 mm Dia	Nos	4			0	0
6.9	Automatic Air vent of 1/2 "	Nos	10			0	0
6.10	Closed Expansion Tank with Expansion Vessel and pressurizing Pumps 1Working + 1 Standby.The tank capacity to be 500 Ltr . Expansion tank to be of S S Construction with Armaflex / K- Flex Insulation 32 mm thick & 26 Gage Aluminum Cladding with diamond finish and with related piping, Isolating valves , Safety valves , Drains, Overflow and Guages	Nos	1			0	0
6.11	Air Separator for Chilled Water in MS construction with SS internal perforated sheet, with Armaflex / K Flex insulation 32 mm & 26 Gage Aluminum Cladding with diamond finish and necessary valves etc.suitable for the following flow rates.						
6.11.1	Flow rate 400 US GPM	Nos	1			0	0
6.12	Ion Exchange make Dosing chemicals for the commissioning of the system and chemicals for the 6 months operation./ Equivalent Dosing chemicals like Sodium Hypochloride etc or eq. inclusive of chemical dosing pot and pumping station for the same.(Min two flusings are required)	Lot	1			0	0
	<b>TOTAL VALUE FOR CHILLED WATER PIPING</b>					<b>0</b>	<b>0</b>
7	<b>AIR DISTRIBUTION</b>						
7.1	SITC of GI Ducting Factory Fabricated with Duct Mate Flanges as per SMACNA for supply air, with 19 mm insulation of Closed Cell Rubber Nitrile Armaflex Class "O".inclusive of supports 8 mm GI Threaded rod and C channel or Slotted Patt. The GI sheet shall be of 180 GSM coating						
7.1.1	18 gauge	SQM	R.O				
7.1.2	20 gauge	SQM	R.O.				
7.1.3	22 gauge	SQM	125			0	0
7.1.4	24 gauge	SQM	875			0	0

Sl.No	Description of Work	Unit	Qty	Rate (Rs.)		Total (Rs)	
				Supply	Installation	Supply	Installation
7.2	SITC of GI Ducting with Slip On Flanges as per SMACNA for Fresh air, inclusive of supports 8 mm GI Threaded rod and C channel or Slotted Patt. The GI sheet shall be of 180 GSM coating.						
7.2.1	18 guage	SQM	R.O				
7.2.2	20 guage	SQM	R.O.				
7.2.3	22 guage	SQM	R.O.				
7.2.4	24 guage	SQM	50			0	0
7.3	Duct Acoustic Insulation applied inside of duct work with 25 mm thk rigid Fibre Glass 48 Kg/Cum density covered with RP tissue and finished with 26 G Al. Perforated Sheet. Fibre glass should be of Fire Retarded Material.	SQM	200			0	0
7.4	Preinsulated flexible duct with end clamps as required in various sizes as below. The duct shall fire retardant UL standard approved.						
7.4.1	100 - mm Dia	Rmt.	14			0	0
7.4.2	125 - mm Dia	Rmt.	R.O.				
7.4.3	150- mm Dia	Rmt.	R.O.				
7.4.4	200 -mm Dia	Rmt.	R.O.				
7.4.5	250 -mm Dia	Rmt.	R.O.				
7.4.6	300 -mm Dia	Rmt.	90			0	0
7.5	Al Powder coated Jet diffuser - size 350 mm	Nos.	30			0	0
7.6	Aluminium Powder Coated Supply and Return Air Linear Slot Diffuser , with Volume control damper. The diffusers shall be with the following neck sizes.						
7.6.1	20 mm Slot- 8 Slot -1000 mm Length-Neck Size -285 mm	Nos.	88			0	0
7.7	Aluminium Powder Coated Supply Air Square Diffuser , with Volume control damper.						
7.7.1	600 mm X 600 mm	Nos.	4			0	0
7.8	Aluminium Powder coated contineous grill without dampers. all sides flanged, as per site requirement. The grill shall be in accordance with the architectural curve / Line of the False ceiling. And used as dummy grille. The grill shall be of radius as per architectural details.	SQM	35			0	0
7.9	Duct type volume control dampers of GI Construction with OBD	SQM	20			0	0
7.10	SLC of Drain Piping shall be HARD PVC . 25mm dia for single unit, 40mm dia for two units and 50mm dia for 3 units. Drain Piping shall be insulated 12mm Armaflex/K-flex rubber nitrile closed cell insulation. The drain shall be released into the nearest toilets.						
7.10.1	25 NB	RMT	60			0	0
7.10.2	32 NB	RMT	40			0	0
7.10.3	50 NB	RMT	100			0	0
7.11	Supply of Duct Inline Fan-500 CFM @ 25MM (Kruger / Nicotra Make) with proper anti vibration isolators and controlled noise level ( 55 db ) For Fresh air supply (SF-1 & SF-2)	Nos	2			0	0
7.12	Aluminium Powder coated Fresh Air intake Louvers, Bird Mesh in Cladding for Fresh Air intake	SQM	15			0	0
7.13	Duct type Fire Damper with fusible link GI construction. The FD shall have 90 min rating	SQM	5			0	0
7.14	Underdeck Insulation Roof insulation with 50mm thick TI-150 Fiberglass Fix 2"X 2" M.S. Clits to the underside of the slab at 2ft X 2 ft grid work.Fix 50mm TI-150 Aluminium faced fiberglass by means of hot bitumen as adhesive in spots. And reinforced the insulation with chicken wire mesh & GI lacing wire	SQM	275			0	0
7.15	SITC of Axial exhaust fan for Dining Area.						
7.15.1	1700 CFM	Nos	2			0	0
<b>TOTAL VALUE FOR AIR DISTRIBUTION</b>						<b>0</b>	<b>0</b>

Sl.No	Description of Work	Unit	Qty	Rate (Rs.)		Total (Rs)	
				Supply	Installation	Supply	Installation
8.0	<b>TOILET VENTILATION SYSTEM</b>						
8.1	Supply and installation of 6" Disc valve. PVC / HDPE Material Only	NOS	10			0	0
8.2	Aluminium Powder Coated 2-Way Supply Air Linear Slot Diffuser , with Volume control damper. The diffusers shall be with the following neck sizes. 20 mm Slot- 4 Slot -1000 mm Length-Neck Size -145 mm	Nos.	6			0	0
8.3	SITC of GI Ducting Factory Fabricated with slip on joints as per SMACNA for Exhaust and make up Fresh air, inclusive of supports 8 mm GI Threaded rod and C channel or Slotted Patt. The coating of the GI sheet shall be min 180 GSM.						
8.3.1		18 guage	SQM	R.O			
8.3.2		20 guage	SQM	R.O.			
8.3.3		22 guage	SQM	R.O.			
8.3.4		24 guage	SQM	80		0	0
8.4	Flexible duct with end clamps as required in various sizes as below. The duct shall fire retardant UL standard approved.						
8.4.1		100 - mm Dia	Rmt.	R.O.			
8.4.2		125 - mm Dia	Rmt.	R.O.			
8.4.3		150- mm Dia	Rmt.	10		0	0
8.4.4		200 -mm Dia	Rmt.	R.O.			
8.4.5		250 -mm Dia	Rmt.	R.O.			
8.4.6		300 -mm Dia	Rmt.	R.O.			
8.5	SITC of Duct Mounted Axial Fan-800 CFM @ 25MM (Kruger / Nicotra Make) with proper anti vibration isolators and controlled noise level ( 55 db ) For Make up Fresh air supply (TSF-1)	NOS	1			0	0
8.6	SITC of Duct Mounted Axial Fan-600 CFM @ 25MM (Kruger / Nicotra Make) with proper anti vibration isolators and controlled noise level ( 55 db ) For Make up Fresh air supply (TSF-2)	NOS	1			0	0
8.7	Domestic Exhaust Fan, suitable for window installation (Kruger / Nicotra Make ) with proper. Of following capacities.						
8.7.1		300 CFM (TEF-7)	NOS	2		0	0
8.7.2		200 CFM (TEF-2)	NOS	1		0	0
8.7.3		125 CFM (TEF-3)	NOS	1		0	0
8.7.4		50 CFM (TEF-4)	NOS	4		0	0
8.8	Ventilation GI Cabinet type Fans complete with drive motor for various ventilation works. Each fan should have static pressure 40 mm WC, of the following capacities. (TEF-1 & 10)						
8.8.1		950 CFM	NOS	2		0	0
8.9	Door Louver in extruded AL construction. The Grill shall be powder coated. The color shall be approved by the architect / consulting engineer before the deliever at site.	SQM	10			0	0
<b>TOTAL VALUE FOR TOILET VENTILATION</b>						<b>0</b>	<b>0</b>
9	<b>HI WALL SPLIT UNIT WORK</b>						
9.1	SITC of High Wall type Split AC with Outdoor Unit ,complete with copper pipes connections,drain pump and connections to drain pipes, supports and hangers,and cordless remote etc. with 407C / 410A as a refrigerant of following capacities.						
9.1.1		1.5 TR	Nos	5		0	0
9.1.2		2.0 TR	Nos	1		0	0
9.2	Refrigerant Piping with 19 mm thick rubber close cell nitrile armaxflex / k flex insulation of following sizes- Inclusive of necessary Supports as per standard practices. Gas Line (in mm.)                      Liquid Line (in mm.)						
9.2.1		15.9		6.40	RMT	R.O	
9.2.2		12.7		6.40	RMT	R.O	
9.3	Piping to be lump sum as per qty required at site and manufacturers standard. Please refer drawing for details	Lot	1			0	0
9.4	Pressure Testing, Nitrogen flushing, gas charging, & commissioning testing of the air conditioning system.	Lot	1			0	0
<b>TOTAL VALUE FOR SPLIT UNIT WORK</b>						<b>0</b>	<b>0</b>
10	<b>ELECTRIFICATION WORK</b>						
10.1	Electrical Panel No 1 : Main Chiller panel						

Sl.No	Description of Work	Unit	Qty	Rate (Rs.)		Total (Rs)	
				Supply	Installation	Supply	Installation
	HVAC Utility Panels comprising of 1 Incoming Feeder (4 Pole ,630 Amp with Overload Earth Fault and Short Circuit protection, MCCB and Outgoing Feeders as mentioned below, The Panel shall be IP-65 Protection for outdoor use,duly powder coated by 7 tank painting process & fabrication of 14/16 Gauge CRCA Sheet.Panel kWh meter, R-Y-B indication Lamps, Control Fuses & AL Bus Bar. Feeders complete with MPCB, Push Buttons, ON, OFF, & Trip indication etc. Location: Terrace Lvl. + 15.0 mtr . Panels are to be with bottom entry. The panel should be with appropriate cooling/heating arrangement. Supplier to furnish the power/Heat loss calculation. and outgoing feeder as below	NOS	1			0	0
	Outgoing Feeder:-						
	FD-1-AHU-1 - 32 A						
	FD-2-AHU-2- 32 A						
	FD-3-AHU-3-32 A						
	FD-4-AHU-4- 32 A						
	FD-5-AHU- 5- 15 A						
	FD-6-AHU-6- 15A						
	FD-7-AHU-7- 32 A						
	FD-8-AHU-8- 32A						
	FD-9-AHU-9 - 15 A						
	FD-10-AHU-10 - 15 A						
	FD-11-Chiller-1 - 250 A						
	FD-12-Chiller-2 - 250 A						
	FD-13-Primary Pump- 15 A						
	FD-14-Primary Pump- 15 A						
	FD-15-Primary Pump- 15 A						
	FD-16-ODU-1- 15 A						
	FD-17-ODU-2- 15 A						
	FD-18-ODU-3- 15 A						
	FD-19-ODU-4- 15 A						
	FD-20-ODU-5- 15 A						
	FD-21-ODU-6- 15 A						
	FD-13-Spare-1- 32A						
	FD-14-Spare-2- 32A						
	FD-15-Spare-3-63A						
	FD-16-Spare-4-63A						
10.2	Electrical cabling from panel to each units as of required size.						
10.2.1	4C X 4 Sq.mm AYWY	RMT	550			0	0
10.2.2	3 C X 4 Sq.mm 2XWY	RMT	200			0	0
10.2.3	3.5 C X 120 Sq.mm A2XFY	RMT	55			0	0
10.3	Supply, laying and connection of copper earthing 25mm x 3mm thick copper strip between Outdoor unit and earth	RMT	150			0	0
10.4	Electrical Cabling between indoor unit and 5 A Socket, 3 C	RMT	125			0	0
	<b>TOTAL VALUE FOR ELECTRIFICATION WORK</b>					<b>0</b>	<b>0</b>
	<b>SUMMARY</b>						
	<b>TOTAL VALUE FOR CHILLERS</b>					<b>0</b>	<b>0</b>
	<b>TOTAL VALUE FOR PUMPS</b>					<b>0</b>	<b>0</b>
	<b>TOTAL VALUE FOR AHUs</b>					<b>0</b>	<b>0</b>
	<b>TOTAL VALUE FOR CHILLED WATER CASSETTE</b>					<b>0</b>	<b>0</b>
	<b>TOTAL VALUE FOR CHILLED WATER PIPING</b>					<b>0</b>	<b>0</b>
	<b>TOTAL VALUE FOR AIR DISTRIBUTION</b>					<b>0</b>	<b>0</b>
	<b>TOTAL VALUE FOR TOILET VENTILATION</b>					<b>0</b>	<b>0</b>
	<b>TOTAL VALUE FOR SPLIT UNIT WORK</b>					<b>0</b>	<b>0</b>
	<b>TOTAL VALUE FOR ELECTRIFICATION WORK</b>					<b>0</b>	<b>0</b>
					<b>TOTAL</b>	<b>0</b>	<b>0</b>
	<b>GRAND TOTAL (SUPPLY + INSTALLATION)</b>					<b>0</b>	<b>0</b>



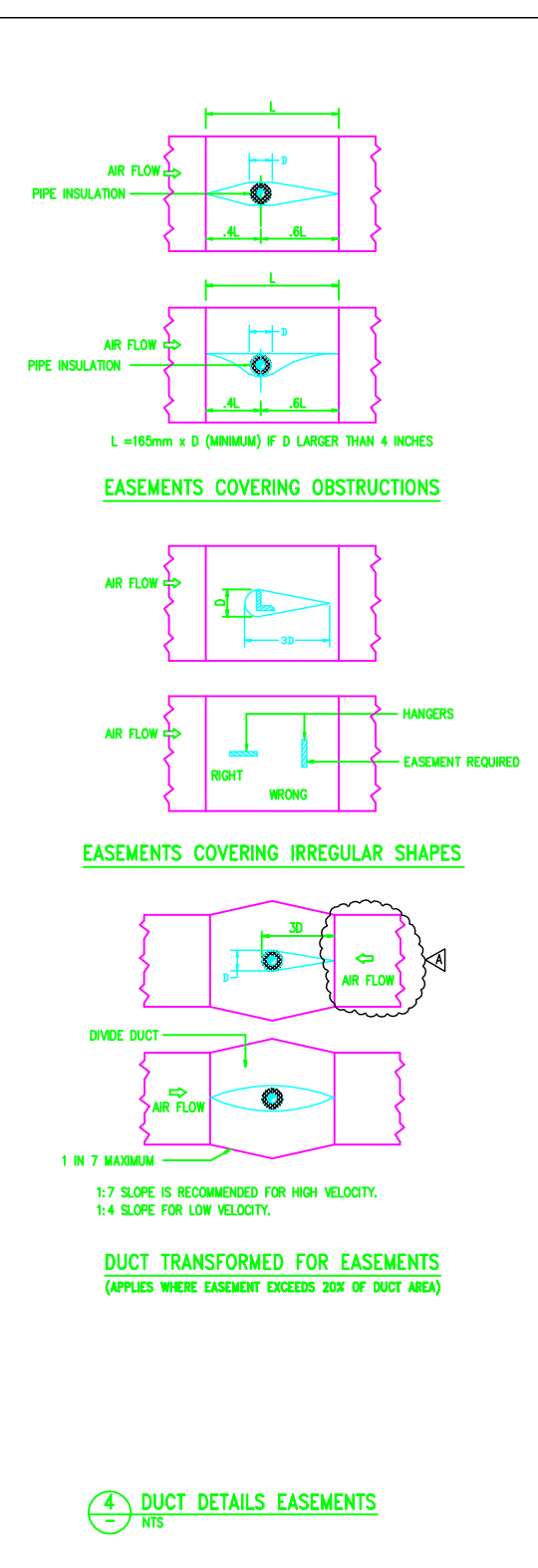
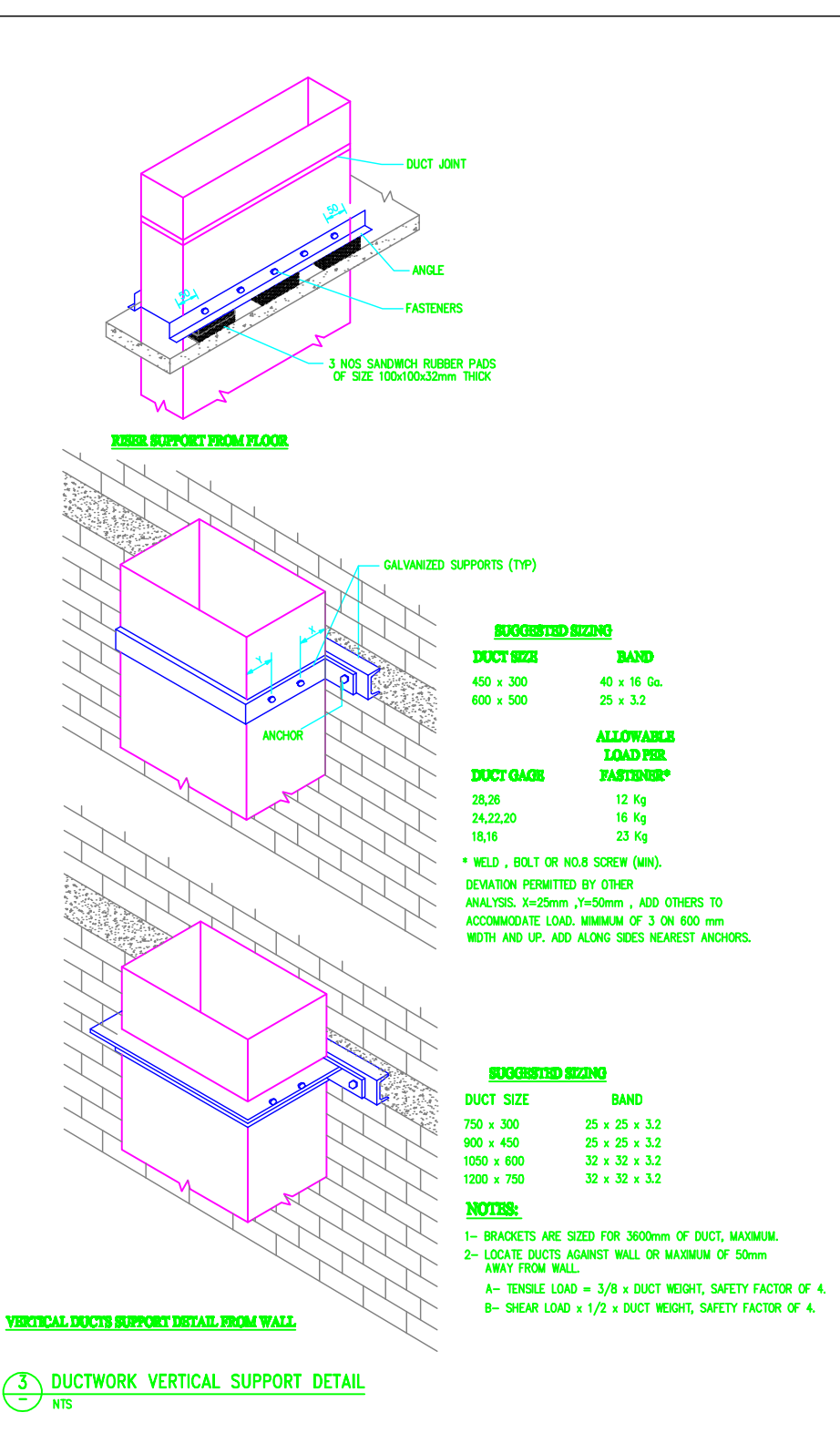
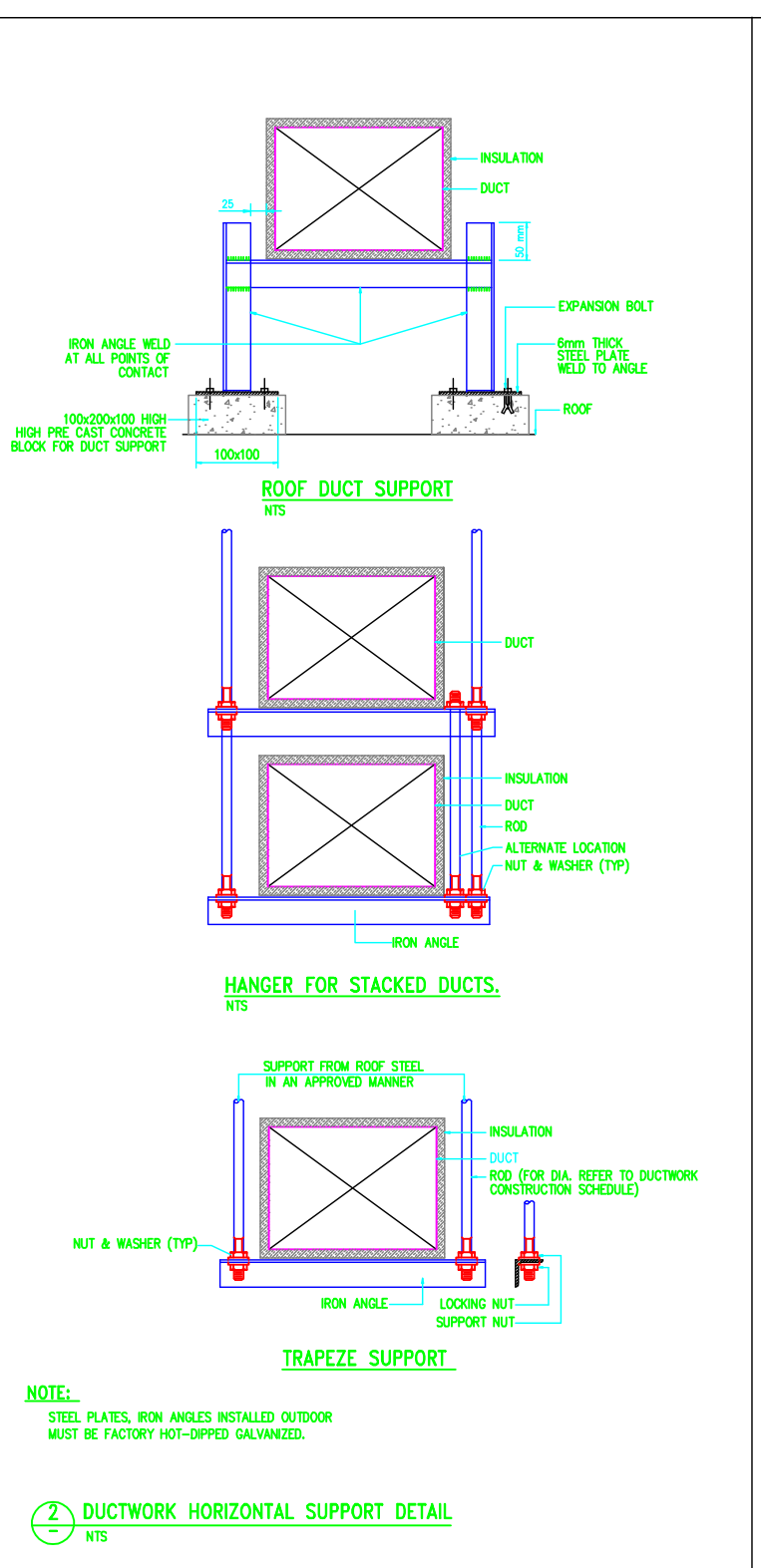
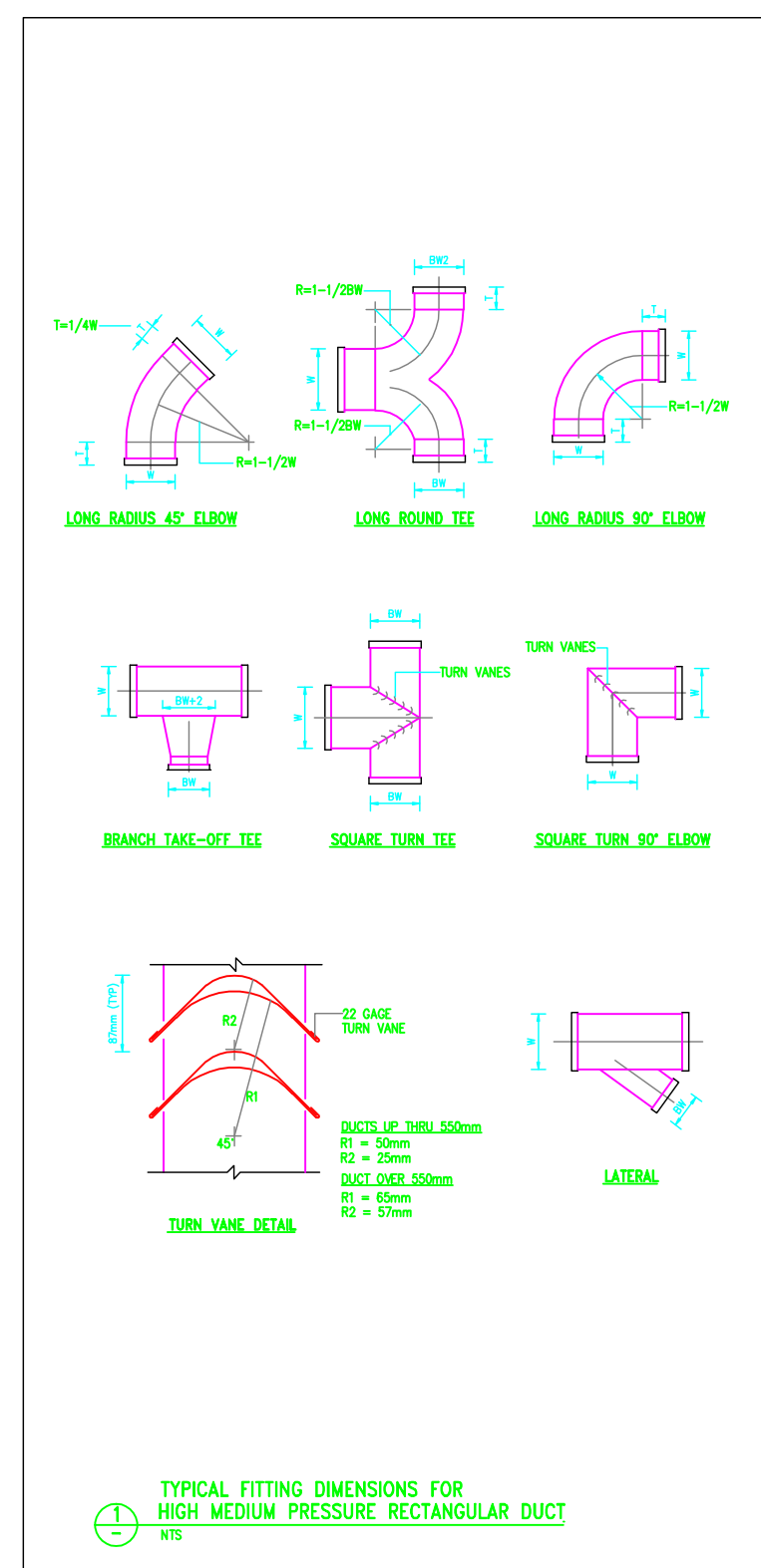

**SCHEDULE OF DUCTWORK CONSTRUCTION LOW PRESSURE CLASS**

METAL GAUGE	TRANSVERSE JOINTS	TRANSVERSE BRACING	HANGERS
STEEL	CONSTRUCTION	SPACING	SIZE
26 (0.8 mm)	DRIVE SLIP	NONE	40x40mm OR 25x25mm STRAP
24 (0.7 mm)	DRIVE SLIP	NONE	40x40mm OR 25x25mm STRAP
24 (0.7 mm)	DRIVE SLIP	NONE	40x40mm OR 25x25mm STRAP
22 (0.6 mm)	DRIVE SLIP	NONE	40x40mm OR 25x25mm STRAP
20 (0.6 mm)	DRIVE SLIP	NONE	40x40mm OR 25x25mm STRAP
18 (0.5 mm)	DRIVE SLIP	NONE	40x40mm OR 25x25mm STRAP

**LOW PRESSURE GALVANIZED STEEL DUCTWORK SPECIFICATION TABLE**  
N/S

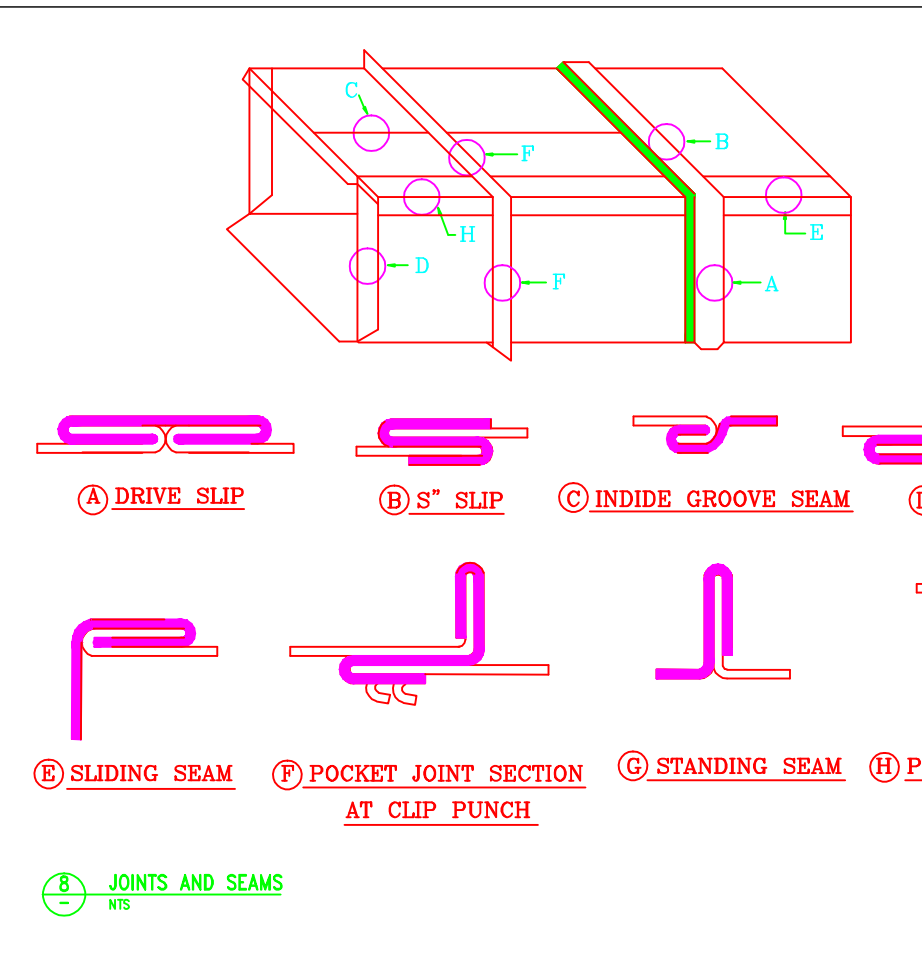
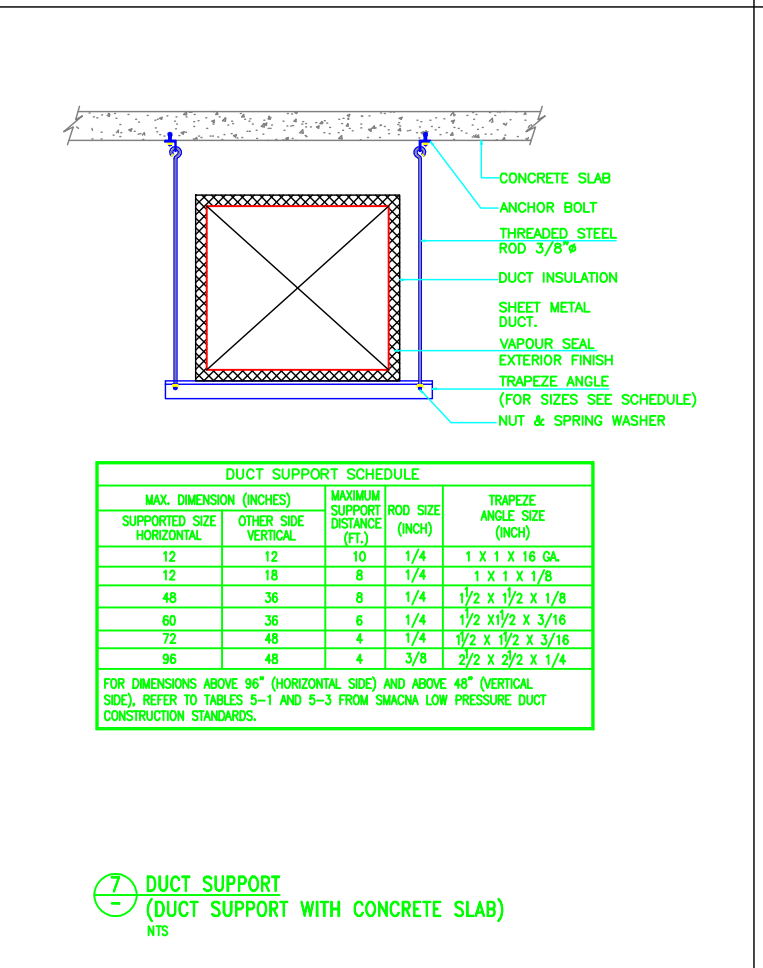
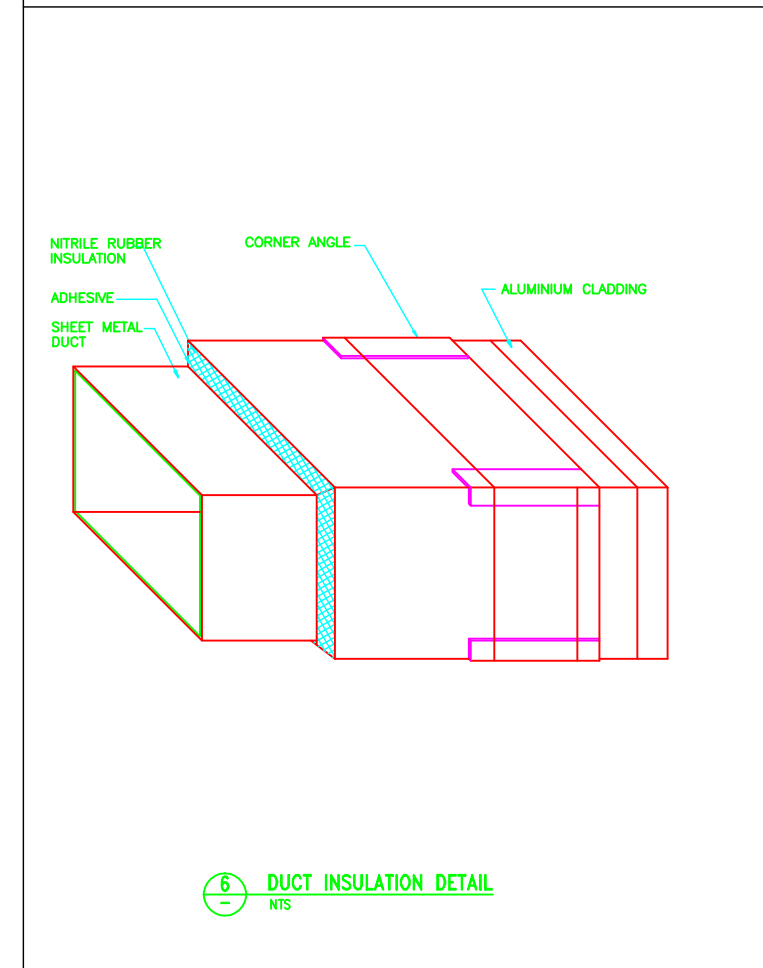

**SHEET METAL GAUGE AND BRACING**  
N/S

MAX. SIDE INCHES	U.S. STD. GAUGE	TRANSVERSE JOINTS & BRACING	SKETCH
UP TO 12"	24	1" POCKET JOINT AT 8FT. CENTRES.	POCKET JOINT
13" - 18"	24	1" POCKET JOINT AT 8FT. CENTRES WITH CROSS BRACING.	CROSS BRACING
19" - 30"	22	1" POCKET JOINT AT 4FT. CENTRES WITH CROSS BRACING.	CROSS BRACING
31" - 42"	22	1" POCKET JOINT AT 4FT. CENTRES WITH CROSS BRACING & 1/2" x 1/4" ANGLE OR 1/2" x 1/4" ANGLE BOLTED TO THE POCKET JOINTS.	POCKET JOINT
43" - 54"	20	1/2" POCKET JOINT AT 4FT. CENTRES WITH CROSS BRACING & 1/2" x 1/4" ANGLE OR 1/2" x 1/4" ANGLE BOLTED TO THE POCKET JOINTS.	POCKET JOINT
55" - 72"	20	1/2" POCKET JOINT AT 4FT. CENTRES WITH CROSS BRACING & 1/2" x 1/4" ANGLE OR 1/2" x 1/4" ANGLE BOLTED TO THE POCKET JOINTS.	POCKET JOINT
73" & UP.	18	3/4" x 1/2" x 1/4" ANGLE BOLTED TO THE DUCT WITH 3/4" BOLTS AT 1/2" CENTRES & FASTENED TOGETHER WITH 3/4" BOLTS AT 2' CENTRES WITH RUBBER GASKET BETWEEN THE TWO ANGLES. THIS PAIR OF ANGLE LOCATED AT 8FT. CENTRES.	POCKET JOINT

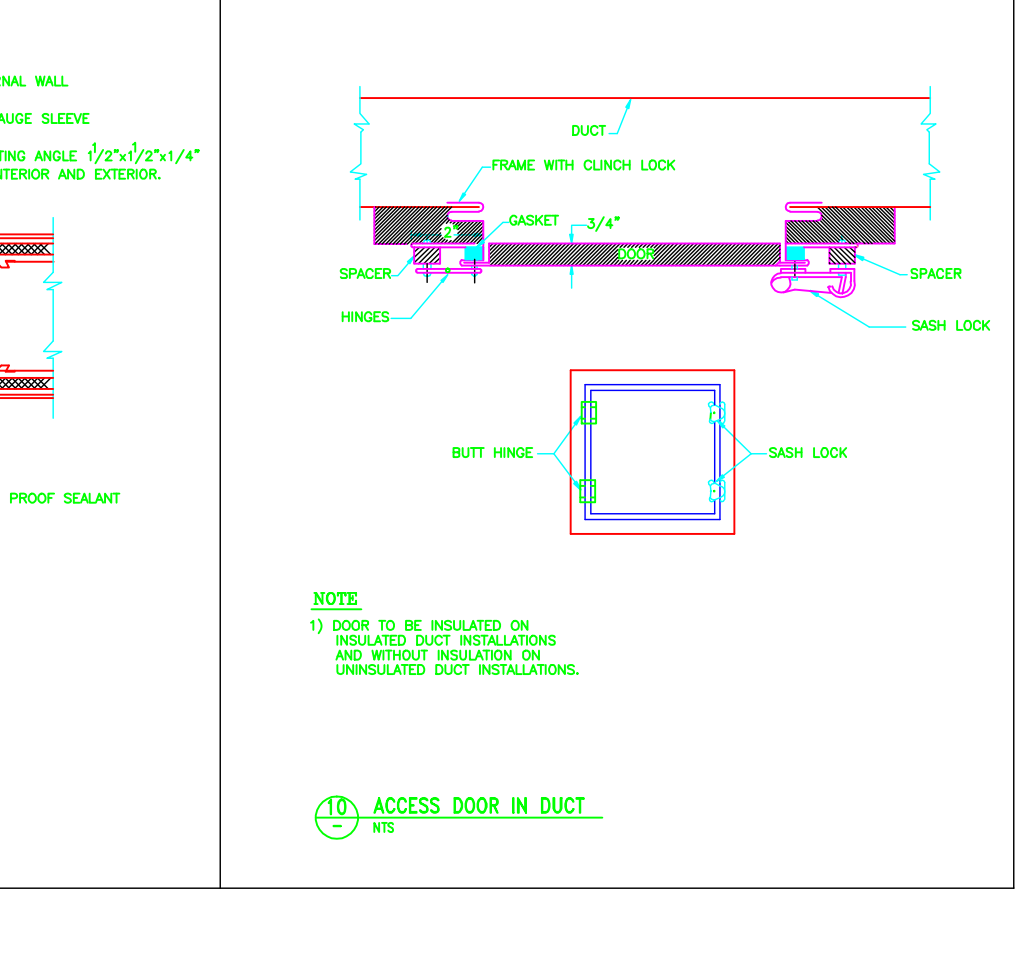
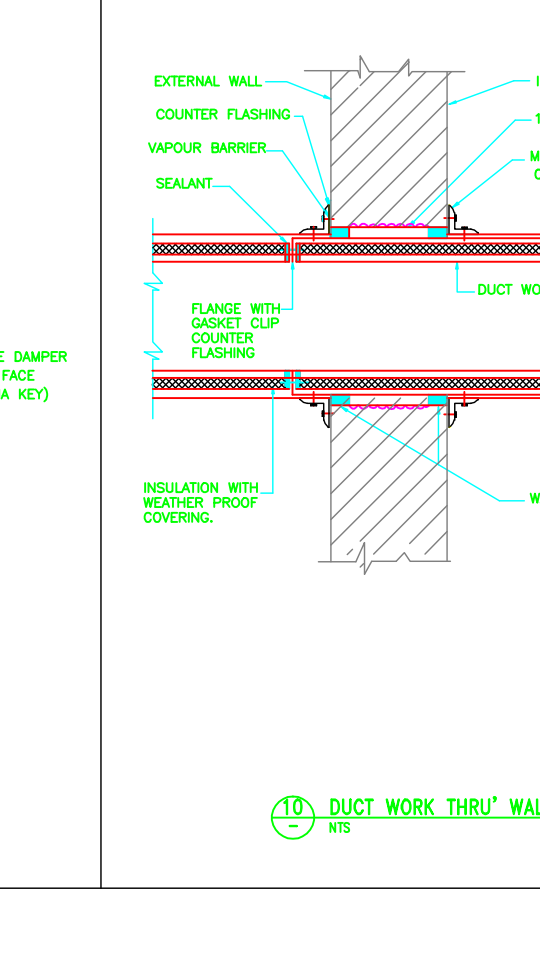
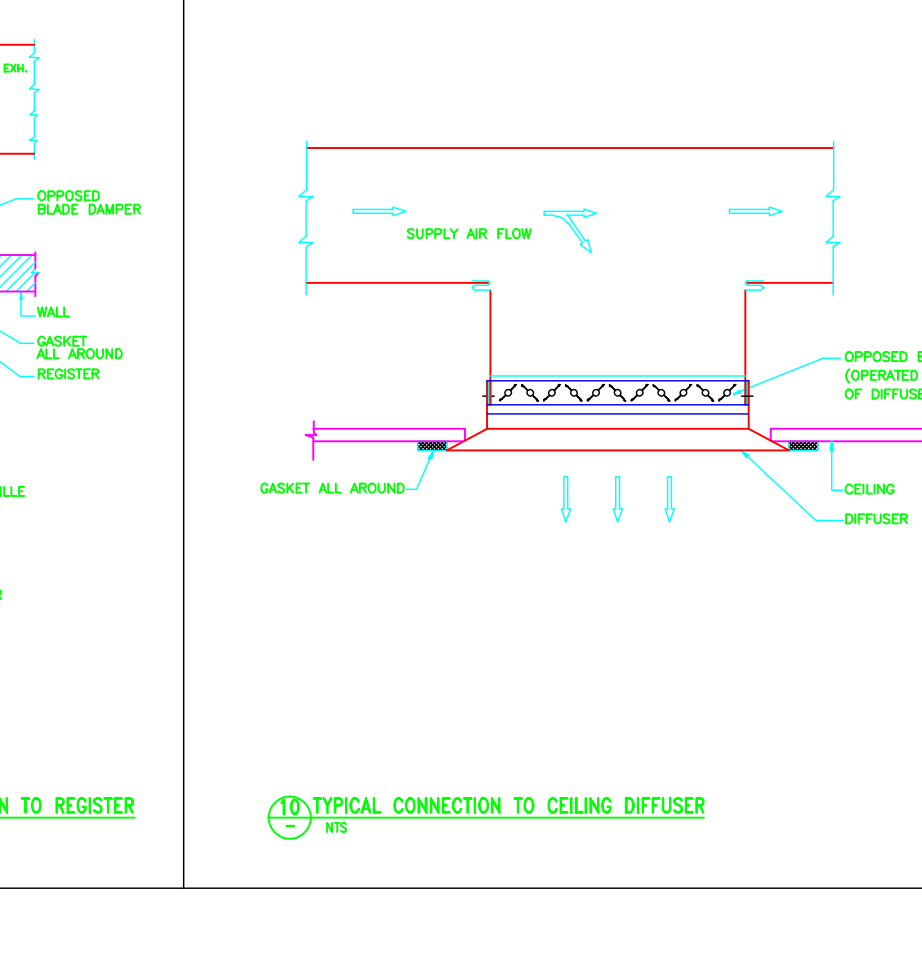
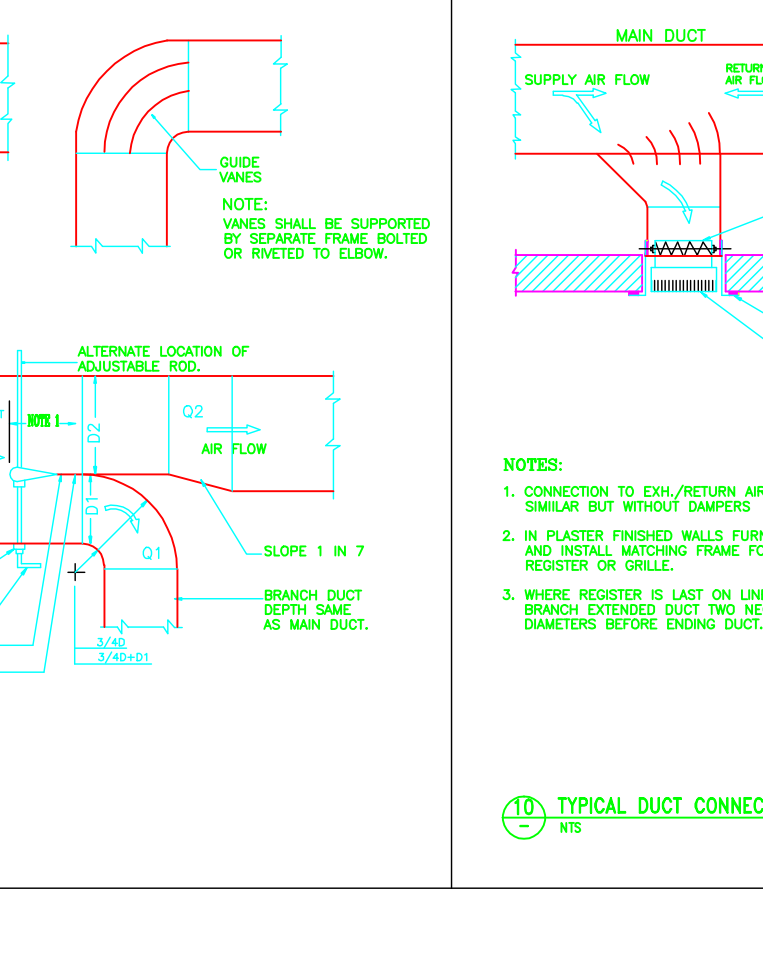
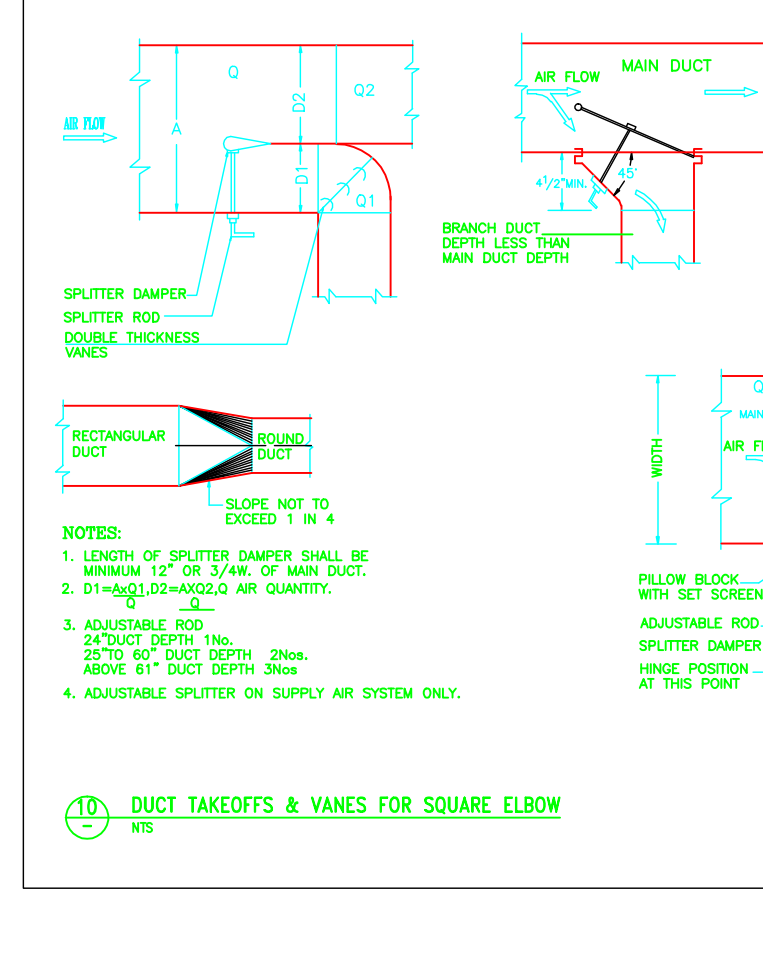

THIS DRAWING IS THE PROPERTY OF ARCHWISTA ENGS. PVT. LTD. IT IS ISSUED FOR PRELIMINARY ENGINEERING & APPROVAL. ANY REUSE, DUPLICATION, ALTERATION OR REUSE FOR ANOTHER PURPOSE IS STRICTLY PROHIBITED & SHALL BE DEEMED LEGALLY AS PROCEEDING WITH THE COMPANY.

DRAWING TITLE		HVAC TYPICAL DUCT SUPPORT DETAIL	
PROJECT		MULTI FACILITY TRAINING BUILDING	
CLIENT		I.I.T.M PUNE	
REV.	DATE	STATUS	
R0	08.09.2011	TFNDR ISSUFI	
08			
05			
04			
03			
02			
01			
00	RTHAN 08.09.2011	RAKFSH 08.09.2011	SUMANT 08.09.2011
DRWN BY & DATE	CHECKED BY & DATE	APP/PAUTH BY & DATE	TFNDR ISSUFI
REFERENCE DRAWING		ALTERATION	
DRG. NO:- T_705_DE01_00			



**DUCTING NOTES :**

- 1.The drawing shows general arrangement and location of the equipment, duct work, piping etc. The contractor shall be responsible for coordinating the mechanical installation with the structure, electrical and other services and shall provide additional offsets and fittings as necessary.
- 2.Duct dimensions on drawings are clear inside dimensions.
- 3.Sheets used for fabrication shall be free from any corrosion.
- 4.Duct work shall be constructed from hot dip galvanized sheet steel to BS:2989 Grade Z.
- 5.The thickness of the sheet shall be in accordance with duct size as per SMACNA/DW-142.
- 6.The duct work shall be supported from main structure using angle iron supports and threaded rods. Supports shall be adequate to take the load without deforming the duct. Support system as per site condition
- 7.All steel work for supports shall be painted with approved anti corrosive paint.
- 8.The insulation of duct work shall be done after testing.
- 9.All duct work for supply air, return air, fresh air shall be insulated with Nitrile rubber of closed cell 19 mm thick ,Class "O"
- 10.The grilles/diffusers shall be selected to maintain noise level less than 35 db.
- 12.The volume control dampers shall be provided where ever required for balancing air flow. The balancing shall achieve flow rates within +/-10 % of specified value.

**VALVE STATIONS :-**

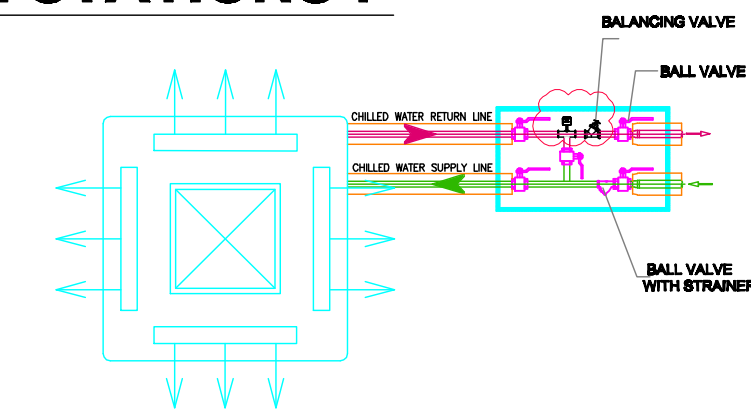

**LEGEND**

SR NO.	SYMBOL	DESCRIPTION
1		VOLUME CONTROL DAMPER
2		CANVASS CONNECTION
3		CHILLED WATER SUPPLY PIPING
4		CHILLED WATER RETURN PIPING
5		CASSETTE UNIT
6		AIR HANDLING UNIT
7		FRESH AIR INTAKE LOUVER
8		FRESH AIR DUCT
9		

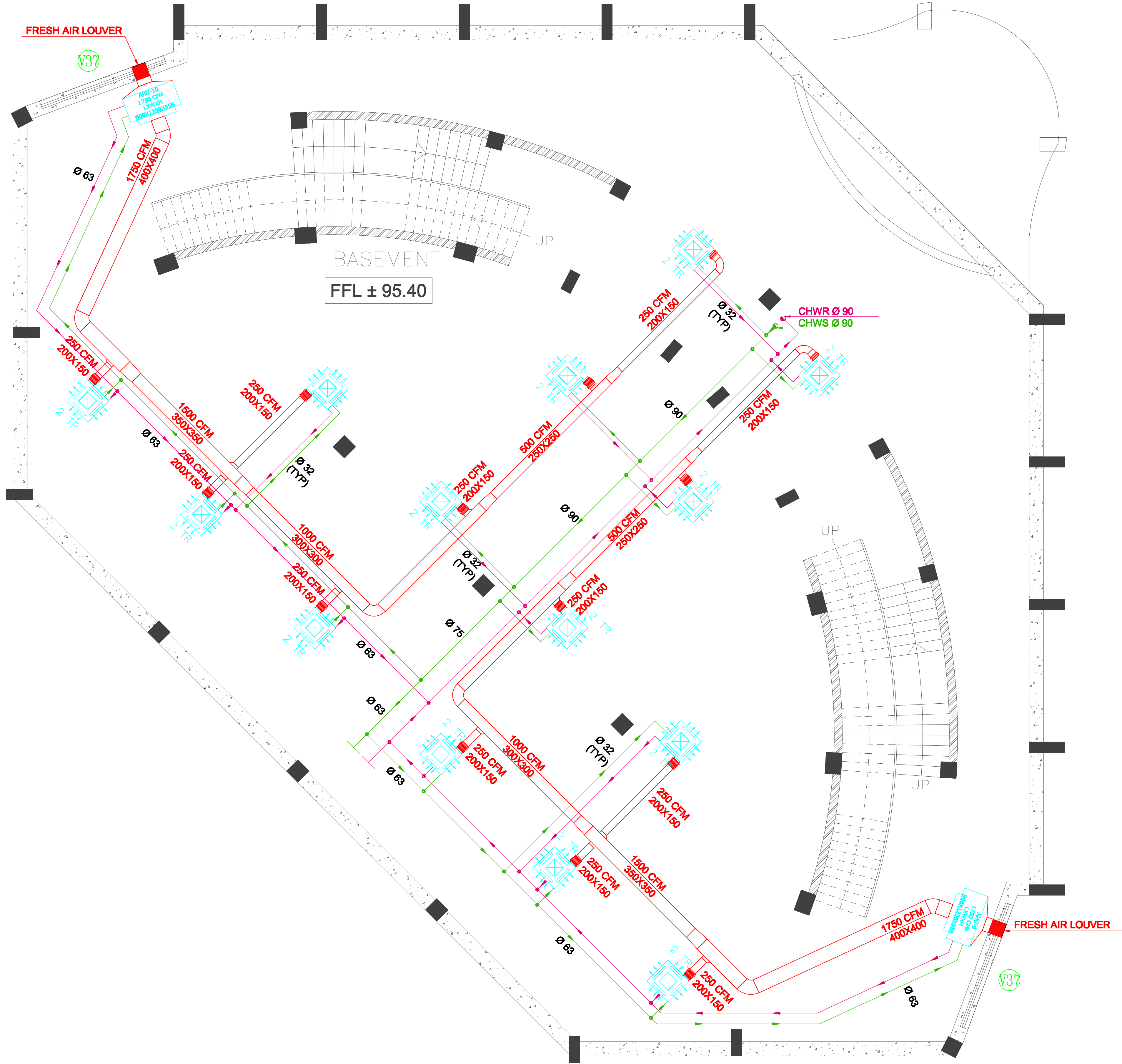

THIS DRAWING IS THE PROPERTY OF ARCHWISATA ENGS. PVT. LTD. IT IS ISSUED FOR PRELIMINARY ENGINEERING & APPROVAL ONLY. REUSE, REPRODUCTION, ALTERATION OR USE FOR ANOTHER PURPOSE IS STRICTLY PROHIBITED & SHALL BE DEEMED LEGAL PROCEEDINGS RESERVED WITH THE COMPANY.

REV	DRWN BY & DATE	CHECKED BY & DATE	APPROVAL BY & DATE	ALTERATION
06				
05				
04				
03				
02				
01	RTHAN 09.09.2011	RAKFSH 09.09.2011	SUMANT 09.09.2011	TFNDR ISSUFI
00	RTHAN 08.09.2011	RAKFSH 08.09.2011	SUMANT 08.09.2011	ISSUED FOR APPROVAL

DRAWING TITLE		
HVAC LAYOUT FOR BASEMENT FLOOR PLAN.		
PROJECT		
MULTI FACILITY TRAINING BUILDING		
CLIENT		
I.I.T.M PUNE		
REV.	DATE	STATUS
R0	08.09.2011	ISSUED FOR APPROVAL
R0	09.09.2011	TFNDR ISSUFI
DRG. NO:- T_705_FPBP_DU		

REFERENCE DRAWING



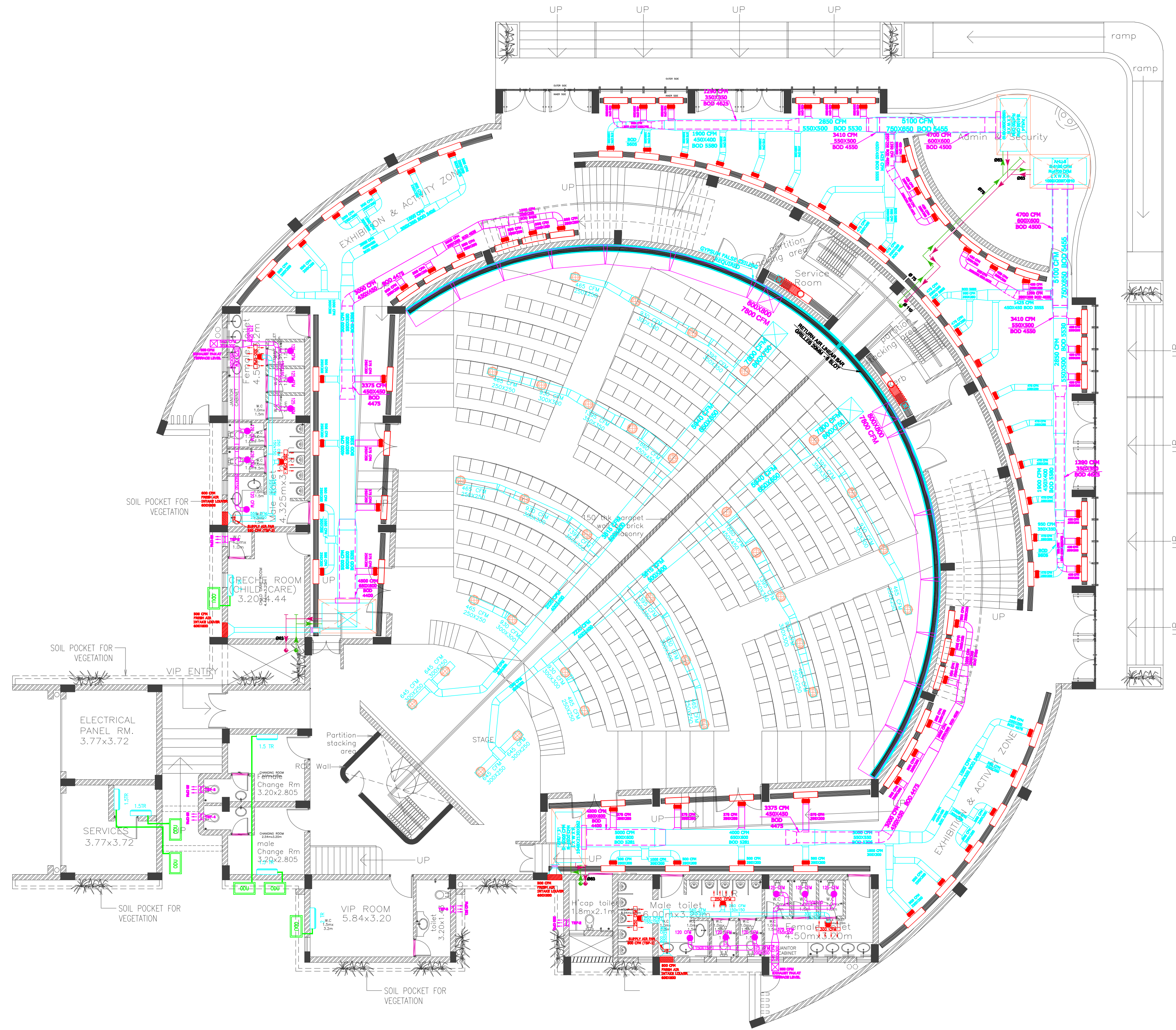

**DUCTING NOTES :**

- 1.The drawing shows general arrangement and location of the equipment, duct work, piping etc. The contractor shall be responsible for coordinating the mechanical installation with the structure, electrical and other services and shall provide additional offsets and fittings as necessary.
- 2.Duct dimensions on drawings are clear inside dimensions.
- 3.Sheets used for fabrication shall be free from any corrosion.
- 4.Duct work shall be constructed from hot dip galvanized sheet steel to BS:2989 Grade Z.
- 5.The thickness of the sheet shall be in accordance with duct size as per SMACNA/DW-142.
- 6.The duct work shall be supported from main structure using angle iron supports and threaded rods. Supports shall be adequate to take the load without deforming the duct. Support system as per site condition
- 7.All steel work for supports shall be painted with approved anti corrosive paint.
- 8.The insulation of duct work shall be done after testing.
- 9.All duct work for supply air, return air, fresh air shall be insulated with Nitrile rubber of closed cell 19 mm thick ,Class "O"
- 10.The grilles/diffusers shall be selected to maintain noise level less than 35 db.
- 11.All diffusers/grilles shall be extruded aluminum finished with polyester powder coating. Door grilles shall be non vision type.
- 12.The volume control dampers shall be provided where ever required for balancing air flow. The balancing shall achieve flow rates within +/-10 % of specified value.

**LEGEND**

SR NO.	SYMBOL	DESCRIPTION
1		VOLUME CONTROL DAMPER
2		CANVASS CONNECTION
3		ODU PIPING
4		CHILLED WATER SUPPLY PIPING
5		CHILLED WATER RETURN PIPING
6		JET DIFFUSER
7		AIR HANDLING UNIT
8		HI WALL UNIT
9		LINEAR SLOT DIFFUSER
10		FRESH AIR INTAKE LOUVER
11		SUPPLY AIR DUCT
12		RETURN AIR DUCT
13		TOILET EXTRACT DUCT
14		TOILET EXHAUST FAN
15		SUPPLY AIR FAN
16		DISC VALVE
17		DOOR LOUVER
18		OUT DOOR UNIT

<b>DRAWING TITLE</b>		HVAC LAYOUT FOR GROUND FLOOR PLAN.
<b>PROJECT</b>		MULTI FACILITY TRAINING BUILDING
<b>CLIENT</b>		I.I.T.M PUNE
REV.	DATE	STATUS
R0	25.06.2011	PRELIMINARY ISSUFE
R1	08.09.2011	ISSUED FOR APPRITVAL
R1	09.09.2011	TFNDR ISSUFE
DRG. NO:- T_705_FPL0_DU		

06					
05					
04					
03					
02	RTHAN 09.09.2011	RAKFSH 09.09.2011	SUMANT 09.09.2011	TFNDR ISSUFE	
01	RTHAN 08.09.2011	RAKFSH 08.09.2011	SUMANT 08.09.2011	ISSUED FOR APPRITVAL	
00	RTHAN 25.06.2011	RAKFSH 25.06.2011	SUMANT 25.06.2011	PRELIMINARY ISSUFE	
REV	DRWN BY & DATE	CHECKED BY & DATE	APPROVAL BY & DATE	ALTERATION	

REFERENCE DRAWING

THIS DRAWING IS THE PROPERTY OF ARCHWISTA ENGS. PVT. LTD. IT IS ISSUED FOR PRELIMINARY ENGINEERING & APPROVAL. ANY REUSE, DUPLICATION, ALTERATION OR REUSE FOR ANOTHER PURPOSE IS STRICTLY PROHIBITED & SHALL BE DEALT LEGALLY. ALL RIGHTS RESERVED WITH THE COMPANY.







**DUCTING NOTES :**

- 1.The drawing shows general arrangement and location of the equipment, duct work, piping etc. The contractor shall be responsible for coordinating the mechanical installation with the structure, electrical and other services and shall provide additional offsets and fittings as necessary.
- 2.Duct dimensions on drawings are clear inside dimensions.
- 3.Sheets used for fabrication shall be free from any corrosion.
- 4.Duct work shall be constructed from hot dip galvanized sheet steel to BS:2989 Grade Z.
- 5.The thickness of the sheet shall be in accordance with duct size as per SMACNA/DW-142.
- 6.The duct work shall be supported from main structure using angle iron supports and threaded rods. Supports shall be adequate to take the load without deforming the duct. Support system as per site condition
- 7.All steel work for supports shall be painted with approved anti corrosive paint.
- 8.The insulation of duct work shall be done after testing.
- 9.All duct work for supply air, return air, fresh air shall be insulated with rubber nitrile closed cell of 19mm thick ,Class "O"
- 10.The grilles/diffusers shall be selected to maintain noise level less than 35 db.
- 11.All diffusers/grilles shall be extruded aluminum finished with polyester powder coating. Door grilles shall be non vision type.
- 12.The volume control dampers shall be provided where ever required for balancing air flow. The balancing shall achieve flow rates within +/-10 % of specified value.

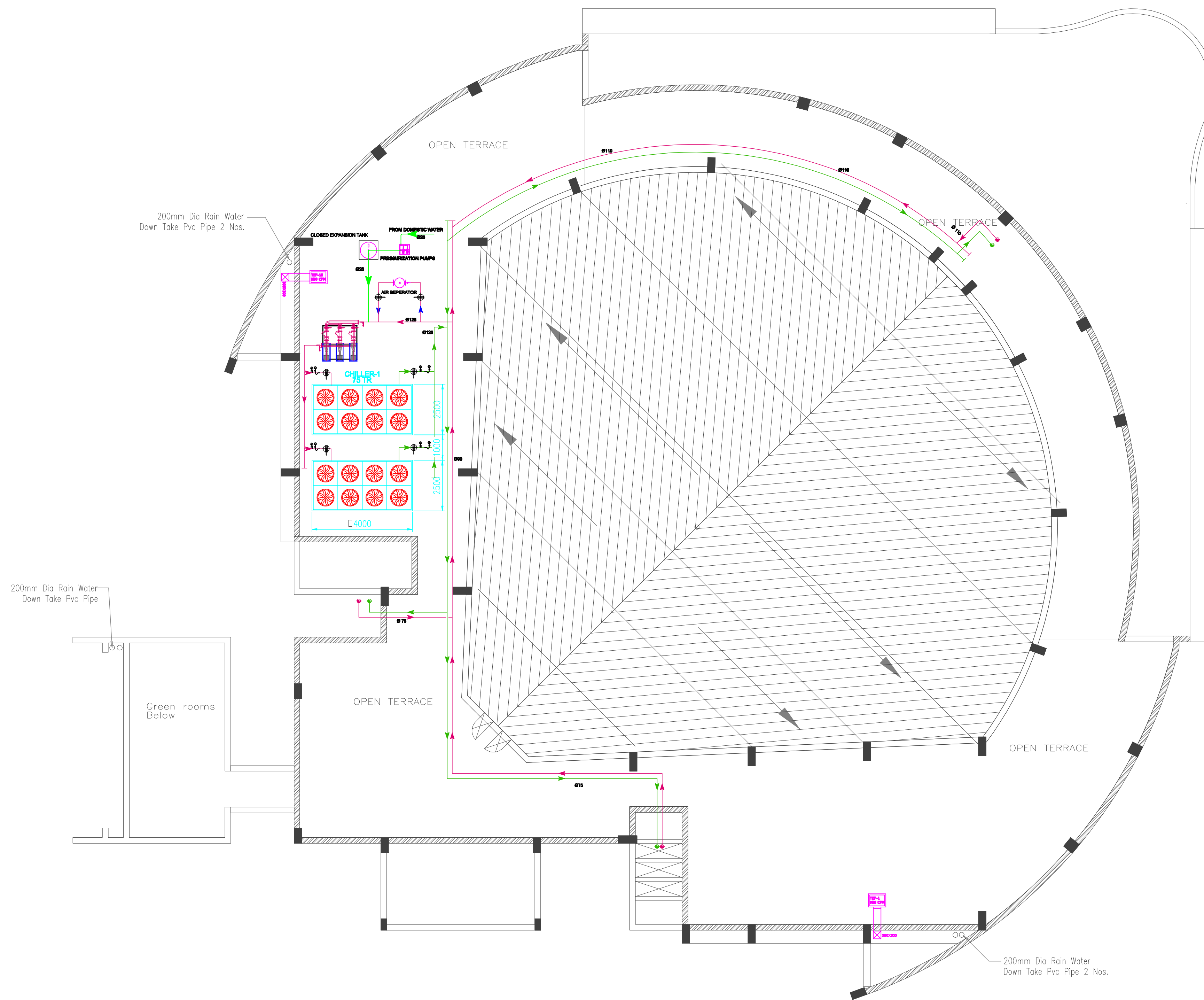

**LEGEND**

SR NO.	SYMBOL	DESCRIPTION
1		TOILET EXTRACT DUCT
2		TOILET EXHAUST FAN
3		CHILLED WATER SUPPLY PIPING
4		CHILLED WATER RETURN PIPING
5		CHILLER ( 75 TR )
6		CLOSED EXPANSION TANK
7		PRESSURIZATION PUMPS
8		AIR SEPERATOR
9		PUMPS
10		

**DRAWING TITLE** HVAC LAYOUT FOR TERRACE FLOOR PLAN.

**PROJECT** MULTI FACILITY TRAINING BUILDING

**CLIENT** I.I.T.M PUNE

REV.	DATE	STATUS
R0	25.06.2011	PRFI IMINARY ISSUF
R1	08.09.2011	ISSUF.D. FDR APPRIVAI
R1	09.09.2011	TFNDR. ISSUF

REFERENCE DRAWING

REV	DRWN BY & DATE	CHECKED BY & DATE	APPAUTH BY & DATE	ALTERATION
06				
05				
04				
03				
02	RTHAN 08.09.2011	RAKFSH 08.09.2011	SUMANT 08.09.2011	TFNDR. ISSUF
01	RTHAN 08.09.2011	RAKFSH 08.09.2011	SUMANT 08.09.2011	ISSUF.D. FDR APPRIVAI
00	RTHAN 25.06.2011	RAKFSH 25.06.2011	SUMANT 25.06.2011	PRFI IMINARY ISSUF